

**BOET**



# Product guide



# Icon guide



**BOET**

**MADE  
FOR YOU**

**94**

**AÑOS A TU LADO.**

// PRESENTACIÓN

// PRESENTATION

// PRÉSENTACIÓN

// Nos complace presentarte nuestro nuevo catálogo de grifería. Nuevos conceptos adaptados a tendencias vanguardistas dan como resultado elegancia y frescura.

Colecciones de diferentes estilos para crear ambientes acogedores, en armonía con el uso responsable del agua.

// We are pleased to present our new faucet catalog. New concepts adapted to vanguard trends result in elegance and freshness.

Collections of different styles to create cozy environments, in harmony with the responsible use of water.

// Nous sommes heureux de présenter notre nouveau catalogue de robinets. Nouveaux concepts adaptés aux tendances d'avant-garde aboutissent à l'élégance et la fraîcheur.

Collections de styles différents pour créer des environnements confortables, en harmonie avec l'utilisation responsable de l'eau.

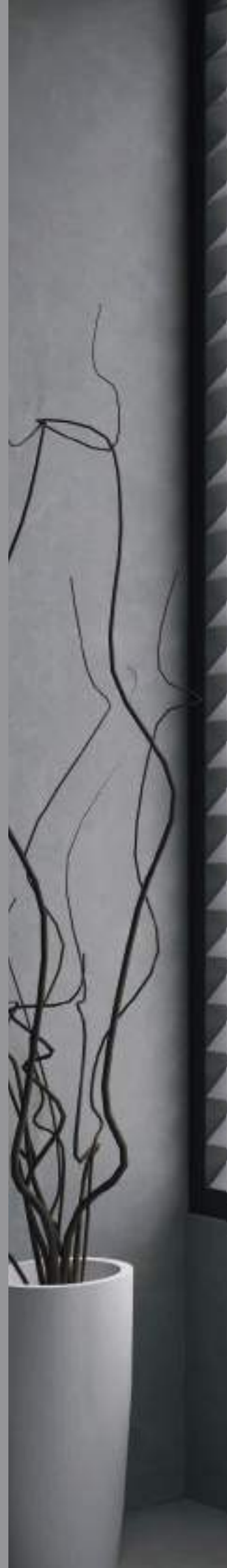





// HISTORIA

// HISTORY

// HISTOIRE

## // Los inicios

Este logotipo representa el inicio de la historia de Boet, que fué en Barcelona en 1928.

93 años fabricando grifería, evolucionando y apostando por nuevos diseños y mejoras técnicas. Pero siempre aplicando el mismo criterio, el que impulsó el Sr. Feliu Boet i Comas.

“ fabricar cada pieza como si fuera única, nuestra premisa es la calidad ”...

## // The start

This logo represents the beginning of the history of Boet, was in Barcelona in 1928.

93 years manufacturing faucets, evolving and betting on new designs and technical improvements.

But always applying the same criteria, the one promoted by Mr. Feliu Boet i Comas.

“Manufacture each piece as if it were unique, our premise is quality” ...

## // Le début

Ce logo représente se début de l’histoire de Boet, était à Barcelone en 1928.

93 ans de fabrication de robinets, évoluant et pariant sur de nouveaux designs et améliorations techniques. Mais toujours en appliquant les mêmes critères, celui promu par M. Feliu Boet i Comas.

“Fabriquez chaque pièce comme si elle était unique, notre prémisse est la qualité”...

# 1928 | 2022

# 1928





1964



1998



2007



2018



2022

// CALIDAD

// QUALITY

// QUALITÉ

AENOR



// Los procesos de fabricación y control de calidad de Boet, son auditados por entes oficiales de diferentes países.

// Boet's manufacturing and quality control processes are audited by official entities from different countries.

// Les processus de fabrication et de contrôle qualité de Boet sont audités par des entités officielles de différents pays





#### // CERTIFICADOS

Los productos de **FELIU BOET**, están fabricados de acuerdo a los estándares europeos de calidad (Norm UNE-EN 19703, UNE-EN-817, UNE-EN-111...), ofreciendo al usuario un producto con la seguridad, fiabilidad y durabilidad esperadas.

Desde la materia prima, hasta el producto final, es sometido a un estricto control de calidad incluyendo pruebas como:

Ensayo estanqueidad | Ensayo de accionamiento y controles | Ensayo de fatiga  
| Ensayos hidráulicos

#### // CERTIFICATES

**FELIU BOET** products are manufactured according to European quality standards (Norm UNE-EN 19703, UNE-EN-817, UNE-EN-111 ...), offering the user a product with the safety, reliability and durability expected .

From the raw material, to the final product, it is subjected to a strict quality control including tests such as:

Sealing test | Test drive and controls | Fatigue test | Hydraulic tests

#### // CERTIFICATS

Les produits **FELIU BOET** sont fabriqués selon les normes de qualité européennes (Norme UNE-EN 19703, UNE-EN-817, UNE-EN-111...), offrant à l'utilisateur un produit avec la sécurité, la fiabilité et la durabilité attendues.

De la matière première au produit final, il est soumis à un contrôle de qualité strict incluant des tests tels que:

Test d'endurance | Essai d'endurance | Test des contrôles





//PRODUCCIÓN

//PRODUCTION

//PRODUCTION

//El desarrollo de un producto desde su diseño hasta su comercialización es un reto, que en BOET afrontamos con responsabilidad e ilusión, aportando la experiencia adquirida en nuestros 93 años de vida. nuestros procesos de fabricación están sujetos a unos estrictos controles internos y son auditados por entes oficiales nacionales e internacionales.

// The development of a product from its design to its marketing is a challenge, that in BOET we face with responsibility and enthusiasm, contributing the experience acquired in our 93 years of life. Our manufacturing processes are subject to strict internal controls and are audited by national and international official entities.

// Le développement d'un produit de sa conception à son marketing est un défi, celui de BOET nous faisons face avec responsabilité et enthousiasme, contribuant l'expérience acquise dans nos 93 années de vie. Nos processus de fabrication sont soumis à des contrôles internes stricts et audités par entités officielles nationales et internationales.



//DISEÑO | DESIGN | DESIGN



//I + D



//FUNDICION | CASTING | FONDERIE



//MECANIZADO | MACHINING | USINAGE



//PULÍDO | POLISHED | POLI



//CROMADO | CHROME | CHROMÉ



//ENSAMBLAJE | ASSEMBLY | ASSEMBLÉE



//POST VENTA | SAT | SAT

//TECNOLOGÍA / ICONOGRAFIA

//TECHNOLOGY / ICONOGRAPHY

//TECHNOLOGIE / ICONOGRAPHIE



---

**//SAVING WATER**

Sistema de reducción del caudal de agua, manteniendo el confort de uso. Limitación a 5-6 l/m en lavabo y 9-10 l/m para ducha.

**//SAVING WATER**

Water flow reduction system, maintaining user comfort. Limitation to 5-6 l / m in washbasin and 9-10 l / m for shower.

**//ÉCONOMISER L'EAU**

Système de réduction du débit d'eau, maintien du confort de l'utilisateur. Limitation à 5-6 l / m dans le lavabo et 9-10 l / m pour la douche.

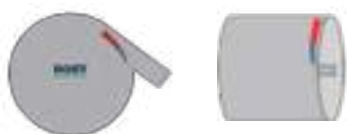
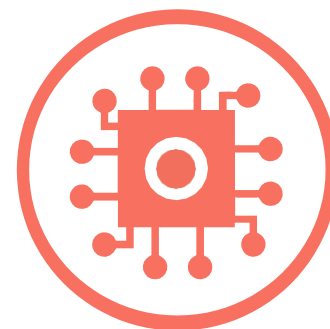
**// CARTUCHO PROGRESIVO**

Grifería con apertura en frío. Regulación del caudal y la temperatura del agua de forma progresiva con mayor confort gracias a la suavidad de funcionamiento del sistema.

**// PROGRESSIVE CARTRIDGE**

Faucets with cold water opening. Flow regulation and the water temperature by progressive smooth engagement system.

**// CARTOUCHE PROGRESSIVE**

Robinets avec ouverture d'eau froide. Régulation du débit et de la température de l'eau au moyen d'un système progressif and mouvement doux.

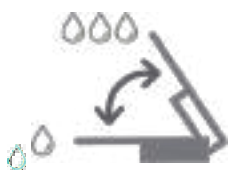
**// CARTUCHO DOBLE CLIC**

Sistema de bajo consumo de agua con dos posiciones de apertura de la maneta. En la posición intermedia se consume el 50% de agua.

**// DOUBLE CLICK CARTRIDGE**

Low water consumption system with two positions for opening the handle. In the intermediate position, 50% of water is consumed.

**// CARTOUCHE DOUBLE CLIC**

Système de faible consommation d'eau avec deux positions pour l'ouverture de la poignée. En position intermédiaire, 50% de l'eau est consommée.

**// CARTUCHO APERTURA AGUA FRÍA**

Sistema de bajo consumo de agua y energía en el que el grifo, en su posición central, abre siempre en agua fría, evitando el encendido innecesario del calentador.

**// CARTRIDGE OPENING COLD WATER**

Low water and energy consumption system in which the tap, in its central position, always opens in cold water, avoiding the unnecessary ignition of the heater.

**// CARTOUCHE OUVERTURE EAU FROIDE**

Système de faible consommation d'eau et d'énergie dans lequel le robinet, dans sa position centrale, s'ouvre toujours dans l'eau froide, évitant ainsi l'allumage inutile du réchauffeur.

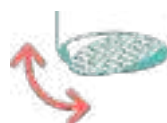
**// AIREADOR ORIENTABLE**

Aireador integrado en el cuerpo del grifo, graduando manualmente la dirección de salida del agua.

**// ORIENTABLE AERATOR**

Aerator integrated in the faucet body, manually adjusting the water outlet direction.

**// AÉRATEUR ORIENTABLE**

Aérateur intégré dans le corps du robinet, ajustant manuellement la direction de sortie de l'eau.

//TECNOLOGÍA

//TECHNOLOGY

//TECHNOLOGIE



#### //STOP SAFE

Botón de seguridad en el regulador de temperatura para no superar involuntariamente los 38° (temperatura confort), y que asegura, en caso de fallo en el suministro de agua fría, el bloqueo automático de la salida de agua, para evitar quemaduras.

#### //STOP SAFE

Safety button on the temperature regulator so as not to inadvertently exceed 38° (comfort temperature), and which ensures, in case of failure in the cold water supply, the automatic blockage of the water outlet, to avoid burns.

#### //ARRÊTER EN TOUTE SÉCURITÉ

Bouton de sécurité sur le régulateur de température afin de ne pas dépasser par inadvertance de 38 ° (température de confort), et qui assure, en cas de défaillance de l'alimentation en eau froide, le blocage automatique de la sortie d'eau, pour éviter les brûlures.



#### // FB TOUCH

Sistema que consigue mantener la superficie del grifo a una temperatura apta para el tacto, evitando quemaduras.

#### //FB TOUCH

System that manages to keep the surface of the tap at a temperature suitable for touch, avoiding burns.

#### //CORP FROID

Système qui parvient à maintenir la surface du robinet à une température adaptée au toucher, en évitant les brûlures.



#### //AUTO CLEAN

Rociadores y manuales de ducha con sistema de autolimpieza.

#### //AUTO CLEAN

Sprinklers and shower manuals with self-cleaning system.

#### //NETTOYAGE AUTOMATIQUE

Gicleurs et manuels de douche avec système autonettoyant.



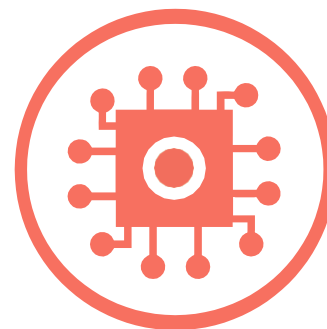

---

**// INVERSOR INTEGRADO EN EL FLEJO**

Sistema de distribución del agua, con el inductor integrado en la conexión con el flexo de ducha, facilitando el accionamiento con las manos húmedas o con jabón.

**// INVERTER CONCEALED**

Water distribution system, with the inverter integrated in the connection with the shower hose, facilitating the operation with wet or soapy hands.

**// INVERSEUR INTÉGRÉ**

Système de distribution d'eau, avec l'inverseur intégré dans la connexion avec le tuyau de douche, facilitant le fonctionnement avec des mains mouillées ou savonneuses.



---

**// CON EQUIPO DE DUCHA**

Set de ducha completo.

**// WITH SHOWER SET**

Complete shower set.

**// AVEC DOUCHE**

Ensemble de douche complet.



---

**// MEDIOAMBIENTE**

Disponemos de productos certificados en tecnología medio ambiental.

**// ENVIRONMENT**

We have products certified in technology environmental way.

**// ENVIRONNEMENT**

Nous avons des produits certifiés dans la technologie d'amélioration de l'environnement.



---

**// SIN EQUIPO DE DUCHA**

Sin complementos de ducha

**// WITHOUT COMPLEMENTS**

Without shower accessories

**// PAS DE COMPLÉMENTS**

Sans accessoires de douche

//TECNOLOGÍA

//TECHNOLOGY

//TECHNOLOGIE



Barra regulable de 93.5 cm a 135.cm.  
Adjustable bar from 93.5 cm to 135.cm.  
Barre réglable de 93,5 cm à 135.cm.



Cartucho termostático y referencia.  
Thermostatic cartridge and reference.  
Cartouche thermostatique et référence.



Alimentación dual, red eléctrica o batería pila AA R6.  
Dual power, mains or AA R6 battery.  
Double alimentation, secteur ou pile AA R6.



Rociador de ducha redondo slim inox y diámetro.  
Round slim stainless steel shower head and diameter.  
Pomme de douche ronde et mince en acier inoxydable et diamètre.



Flexo de ducha, medida y referencia.  
Shower hose, size and reference.  
Tuyau de douche, taille et référence.



Rociador de ducha redondo slim inox y diámetro.  
Round slim stainless steel shower head and diameter.  
Pomme de douche ronde et mince en acier inoxydable et diamètre.

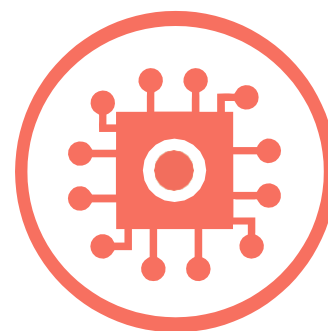

Diámetro y referencia del cartucho cerámico.  
Ceramic cartridge diameter and reference.  
Diamètre et référence de la cartouche céramique.



Rociador ABS autolimpieza y diámetro.  
ABS spray with self-cleaning and diameter.  
Spray ABS avec autonettoyant et diamètre.



Ubicación célula fotoeléctrica.  
Photoelectric cell location.  
Emplacement des cellules photoélectriques.

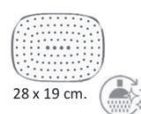

Rociador rectangular ABS autolimpieza y diámetro.  
Rectangular self-cleaning ABS showerhead and diameter.  
Pomme de douche rectangulaire autonettoyante en ABS et diamètre.



Número de posiciones del maneral de ducha.  
Number of positions of the shower handle.  
Nombre de positions de la douchette.

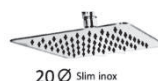

Rociador cuadrado slim inox y diámetro.  
Square slim stainless steel showerhead and diameter.  
Pomme de douche carrée mince en acier inoxydable Et diamètre.



**Monomandos | Basin Mixers | Mitigeurs lavabo**  
La colección de Boet dispone de distintas series para dar soluciones a todos los públicos.



**Cocina | Kitchen | Cuisine**  
Monomandos de cocina, amplia gama de opciones y formatos.



**Colectividades | Colectivities | Colectivités**  
Grifería para equipar baños colectivos y minusvalía.



**Duchas | Showers | Douches**  
Barras de ducha vista, rociadores, empotrados. Variedad de opciones para la ducha.

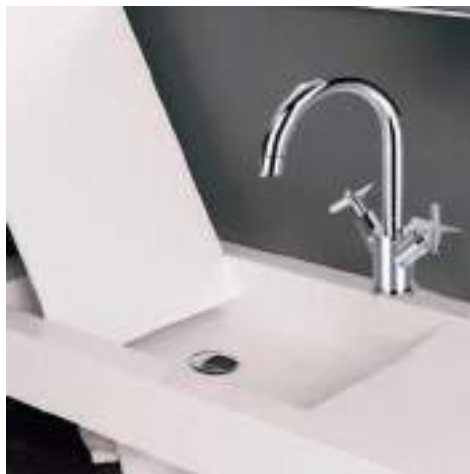

**Bimandos | Mixers | Mélangeur**  
Grifería bimando de diseño moderno y de época.

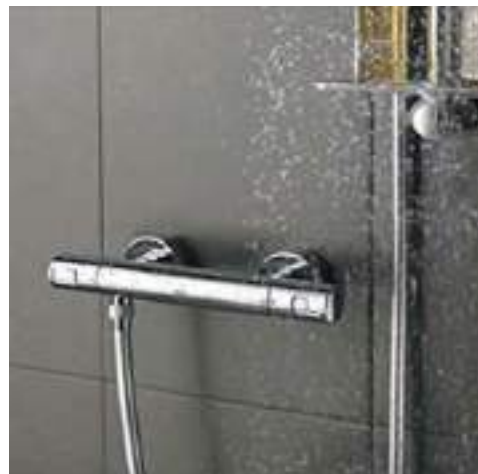

**Termostática | Thermostatic | Thermostatique**  
Equipos termostáticos, vistos, empotrados, barras vistas, etc...

# INDICE ■ INDEX ■ INDICE

|                                 |                |
|---------------------------------|----------------|
| <b>HISTÓRIA</b>                 | <b>4-5</b>     |
| <b>CALIDAD</b>                  | <b>6-7</b>     |
| <b>PRODUCCIÓN</b>               | <b>8-9</b>     |
| <b>TECNOLOGÍA / ICONOGRAFIA</b> | <b>10-11</b>   |
| <b>TECNOLOGÍA</b>               | <b>12-15</b>   |
| <b>BOET SOLUTIONS</b>           | <b>16-17</b>   |
| <b>■ BOET SELECTION</b>         | <b>18-99</b>   |
| Colección TUBE                  | 20 – 27        |
| Colección IRIS                  | 28 – 33        |
| Colección KALI                  | 34-39          |
| Colección ONE                   | 40- 45         |
| Colección APOLO                 | 46-49          |
| Colección MOON                  | 50-53          |
| Colección ARES                  | 54-61          |
| Colección NEOS                  | 62-67          |
| Colección LAST                  | 68-73          |
| Colección OCHO                  | 74-77          |
| Colección PRISMA                | 78-85          |
| Colección TUBULAR               | 86-93          |
| Colección DUO                   | 94-99          |
| <b>■ ECO BOET</b>               | <b>100-212</b> |
| Colección ICE                   | 102-105        |
| Colección JET                   | 106-113        |
| Colección LUCA                  | 114-121        |
| <b>■ BOET PROFESSIONAL</b>      | <b>122-171</b> |
| Colección URBAN                 | 124-129        |
| Colección CITY                  | 130-135        |
| Colección TRIANON MX            | 136-141        |
| Colección BACK                  | 142-147        |
| Colección PLAY                  | 148-155        |
| Colección SEIS                  | 156-159        |
| Colección CINCO                 | 160-165        |
| Colección LINK                  | 166-171        |
| <b>■ BOET COCINA</b>            | <b>172-181</b> |
| Colección COCINA                | 174-181        |
| <b>■ BOET COLECTIVIDADES</b>    | <b>182-199</b> |
| Colección SENSOR                | 184-187        |
| Colección IMPALA                | 188-191        |
| Colección TEMPORIZADAS          | 192-195        |
| Colección ESPECIALES            | 196-199        |
| <b>■ BOET BARRA VISTA</b>       | <b>200-209</b> |
| Colección BARRA VISTA           | 202-209        |
| <b>■ BOET BIMANDO</b>           | <b>210-235</b> |
| Colección TERRA                 | 212-215        |
| Colección CLASSIC               | 216-219        |
| Colección ANTIQUE               | 220-223        |
| Colección VERONA                | 224-231        |
| Colección PISA                  | 232-235        |
| <b>■ BOET TERMAL</b>            | <b>236-245</b> |
| TOUCH                           | 338            |
| TERMOSOL                        | 239            |
| TERMOSTAR                       | 240-241        |
| TERMOFEEL                       | 242-243        |
| TERMAL                          | 244-245        |
| <b>■ BOET SHOWERS</b>           | <b>246-257</b> |
| <b>■ BOET ACCESORIOS</b>        | <b>258-264</b> |
| <b>■ BOET SHOWROOM</b>          | <b>266-273</b> |
| Peanas                          | 270            |
| Paneles                         | 271            |
| Expositores                     | 272-273        |





# BOET SELECTION

TUBE  
IRIS  
KALI  
ONE  
APOLO  
MOON  
ARES  
LAST  
OCHO  
PRISMA  
TUBULAR  
DUO

# BOET SELECTION

# Colección **TUBE**

---

La simplicidad llevada al extremo, se convierte en elegancia.

Simplicity taken to the extreme, becomes elegance.

Simplicité poussée à l'extrême, devient élégance.

John Franklin

---

---



**40 BOET SELECTION**

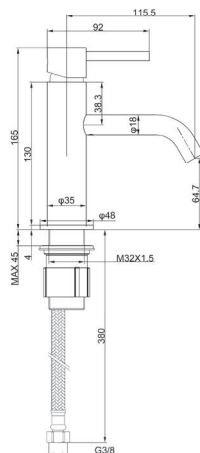

**Ref.: 40107**



Monomando lavabo  
Apertura en frío, ahorro energético

Basin mixer  
Cold opening, energy saving

Mitigeur lavabo  
Ouverture à froid, économie d'énergie

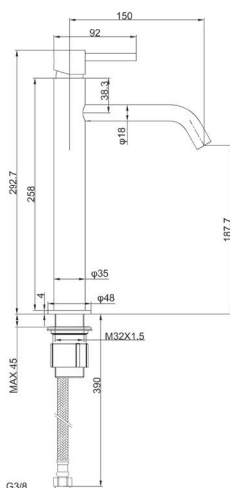

**Ref.: 40109**



Monomando lavabo  
Apertura en frío, ahorro energético

Basin mixer  
Cold opening, energy saving

Mitigeur lavabo  
Ouverture à froid, économie d'énergie





Monomando lavabo  
Empotrado con placa

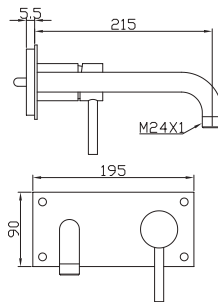

Basin mixer  
Recessed with plate

**Ref.: 40110**



Mitigeur lavabo  
Encastré avec plaque



Monomando lavabo  
Empotrado sin placa

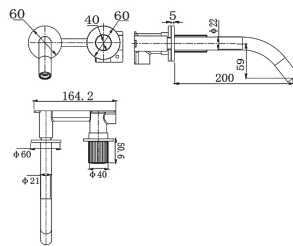

Basin mixer  
Recessed without plate

**Ref.: 40112**



Mitigeur lavabo  
Encastré sans plaque



Monomando bidé  
Con rotula giratoria

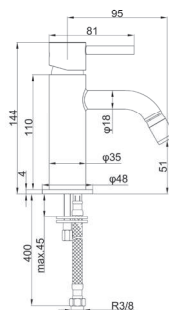

Bidet mixer  
With rotary ball joint

**Ref.: 40227**



Mitigeur bidet  
Avec rotule rotative

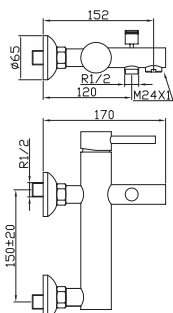

Monomando baño ducha

Mixer bath shower

**Ref.: 40555**



**Ref.: 40555/0**



Mitigeur bain douche avec inverseur

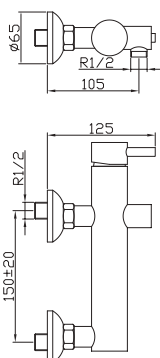

Monomando ducha

Shower mixer

**Ref.: 40424**



**Ref.: 40424/0**



Mitigeur de douche

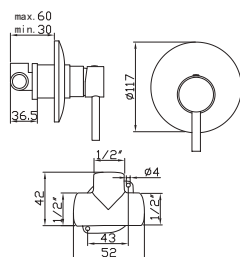

Monomando de ducha empotrado

Concealed bath-shower

**Ref.: 40425**



Mitigeur douche a encastrer

## TUBE

**BOET**



Monomando de ducha empotrado con dos salidas

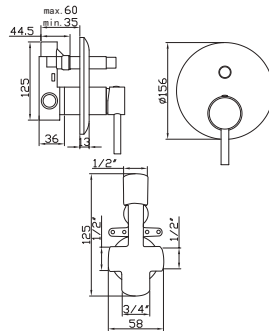

Concealed bath-shower with two outputs

Ref.: 40556



Mitigeur douche a encastrer avec deux sorties



Ref.: Pack TUBE

Pack TUBE, 2 VIAS  
Grifería de ducha empotrada 2 vías con accesorios: brazo de pared, rociador redondo de 20 cm, soporte con toma de agua, flexo y maneral de ducha

Pack TUBE, 2 WAYS  
2-way recessed shower mixer with accessories: wall arm, 20 cm round shower head, support with water connection, hose and shower handle

Pack TUBE, 2 FAÇONS  
Mitigeur de douche à encastrer 2 sorties avec accessoires: bras mural, pomme de douche ronde 20 cm, support avec raccord d'eau, flexible et poignée de douche



Ref.: 82430/3

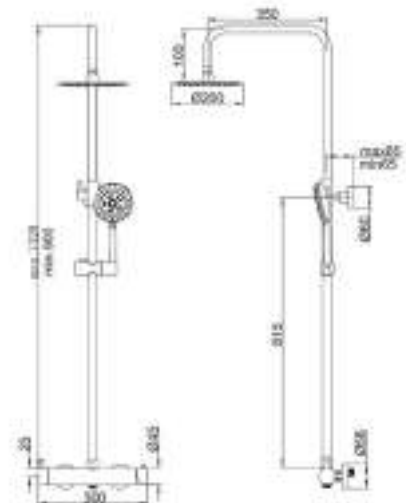

Barra ducha vista monomando selector de función integrado el grifo

Shower mixer tap with shower column function selector integrated in the tap

Melangeur pour douche avec colonne sélecteur de fonction intégré dans en le robinet





Monomando fregadero caño  
silicona giratorio extensible



Ref.: 82693 A



Ref.: 82693 B



Ref.: 82693 R



Ref.: 82693 N

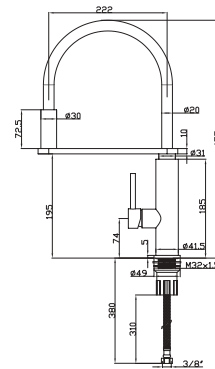

Sink mixer silicone spout  
rotating extendable

Mitigeur evier en silicone  
tournant extensible



# Colección **IRIS**

---

Dime a qué le prestas atención y te diré quién eres.

Tell me what you pay attention to and I'll tell you who you are.

Dis-moi à quoi tu fais attention et je te dirai qui tu es.

Ortega y Gasset

---

---





**10 BOET SELECTION**

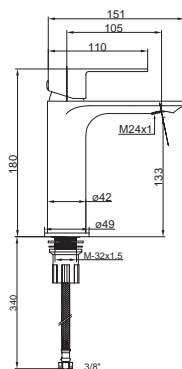

Monomando lavabo  
Apertura en frío, ahorro energético

Basin mixer  
Cold opening, energy saving

**Ref.: 10109**



Mitigeur lavabo  
Ouverture à froid, économie d'énergie

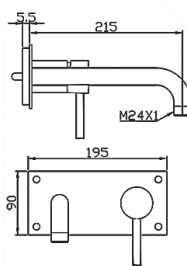

Monomando lavabo  
Empotrado con placa

Basin mixer  
Recessed with plate

**Ref.: 10110**



Mitigeur lavabo  
Encastré avec plaque

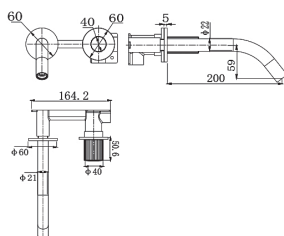

Monomando lavabo  
Empotrado sin placa

Basin mixer  
Recessed without plate

**Ref.: 10112**



Mitigeur lavabo  
Encastré sans plaque



Monomando baño ducha

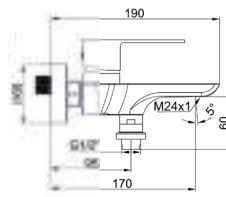

Mixer bath shower

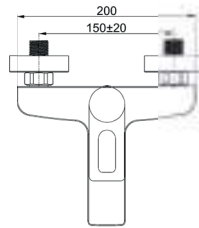

**Ref.: 10555**



**Ref.: 10555/0**



Mitigeur bain douche avec inverseur



Monomando ducha

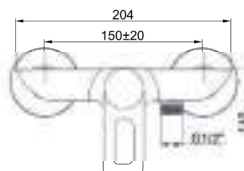
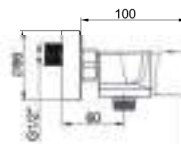

Shower mixer

**Ref.: 10424**



**Ref.: 10424/0**



Mitigeur de douche



Monomando ducha empotrado

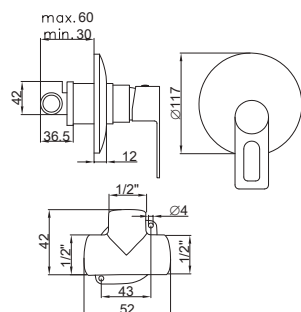

Concealed shower

**Ref.: 10425**



Mitigeur douche a encastrer



Monomando ducha empotrado con dos salidas

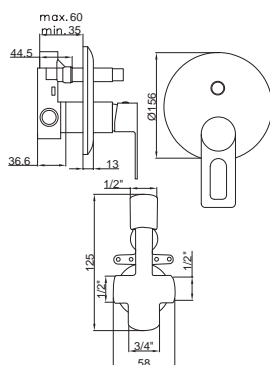

Concealed bath-shower with two outputs

**Ref.: 10556**



Mitigeur douche a encastrer avec deux sorties



**Ref.: Shower Set1**

**SHOWER SET1, 2 VIAS**

Accesorios de ducha para empotrados, incluye brazo pared, rociador, Soporte c/toma, flexo y manual de ducha

**SHOWER SET1, 2 WAYS**

Complete recessed shower kit Includes: wall arm, sprayer, Support w/outlet, hose and shower handle

**SHOWER SET1, 2 FAÇONS**

Kit de douche encastré complet Comprend : bras mural, pulvérisateur, Support avec poignée de douche



**Ref.: Shower Set2**

**SHOWER SET2, 2 VIAS**

Accesorios de ducha para empotrados, incluye brazo pared, rociador, Soporte c/toma, flexo y manual de ducha

**SHOWER SET1, 2 WAYS**

Complete recessed shower kit Includes: wall arm, sprayer, Support w/outlet, hose and shower handle

**SHOWER SET1, 2 FAÇONS**

Kit de douche encastré complet Comprend : bras mural, pulvérisateur, Support avec poignée de douche

# Colección **KALI**

---

El estilo es un reflejo de tu actitud y tu personalidad.

Style is a reflection of your attitude and your personality.

Le style est le reflet de votre attitude et de votre personnalité.

Shawn Amera

---

---



## 13 BOET SELECTION

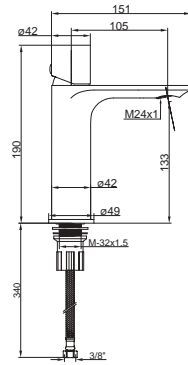

Monomando lavabo  
Apertura en frío, ahorro energético

Basin mixer  
Cold opening, energy saving

**Ref.: 13109**



Mitigeur lavabo  
Ouverture à froid, économie d'énergie

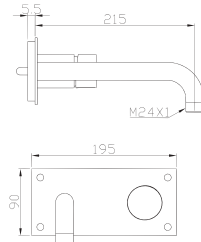

Monomando lavabo  
Empotrado con placa

Basin mixer  
Recessed with plate

**Ref.: 13110**



Mitigeur lavabo  
Encastré avec plaque

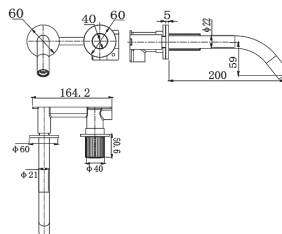

Monomando lavabo  
Empotrado sin placa

Basin mixer  
Recessed without plate

**Ref.: 13112**



Mitigeur lavabo  
Encastré sans plaque





Monomando baño ducha

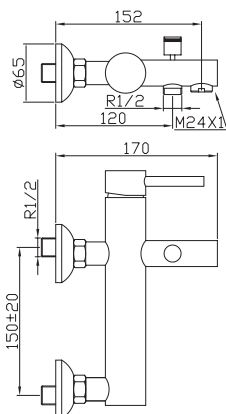

Mixer bath shower

**Ref.: 13555**



**Ref.: 13555/0**



Mitigeur bain douche avec inverseur



Monomando ducha

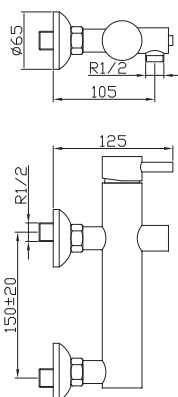

Shower mixer

**Ref.: 13424**



**Ref.: 13424/0**



Mitigeur de douche



Monomando ducha empotrado

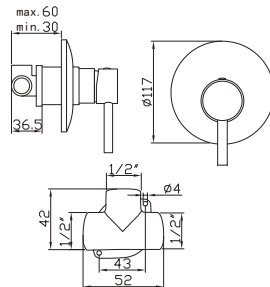

Concealed bath-shower

**Ref.: 13425**



Mitigeur douche a encastrer



Monomando ducha empotrado con dos salidas

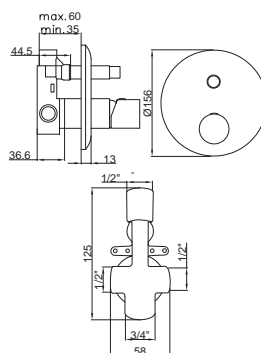

Concealed bath-shower with two outputs

**Ref.: 13556**



Mitigeur douche a encastrer avec deux sorties



**Ref.: Shower Set1**

SHOWER SET1, 2 VIAS  
 Accesorios de ducha para empotrados, incluye brazo pared, rociador, Soporte c/toma, flexo y manual de ducha

SHOWER SET1, 2 WAYS  
 Complete recessed shower kit  
 Includes: wall arm, sprayer, Support w/outlet, hose and shower handle

SHOWER SET1, 2 FAÇONS  
 Kit de douche encastré complet  
 Comprend : bras mural, pulvérisateur, Support avec poignée de douche



**Ref.: Shower Set2**

SHOWER SET2, 2 VIAS  
 Accesorios de ducha para empotrados, incluye brazo pared, rociador, Soporte c/toma, flexo y manual de ducha

SHOWER SET1, 2 WAYS  
 Complete recessed shower kit  
 Includes: wall arm, sprayer, Support w/outlet, hose and shower handle

SHOWER SET1, 2 FAÇONS  
 Kit de douche encastré complet  
 Comprend : bras mural, pulvérisateur, Support avec poignée de douche

# Colección **ONE**

---

¡El diseño accesible..., es buen diseño!

Accessible design... is good design!

Le design accessible... c'est du bon design!

Steve Balmer

---



**44 BOET SELECTION**

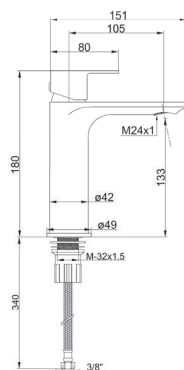

**Ref.: 44109**



Monomando lavabo  
Apertura en frío, ahorro energético

Basin mixer  
Cold opening, energy saving

Mitigeur lavabo  
Ouverture à froid, économie d'énergie

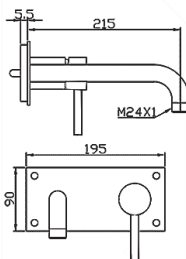

**Ref.: 44110**



Monomando lavabo  
Empotrado con placa

Basin mixer  
Recessed with plate

Mitigeur lavabo  
Encastré avec plaque

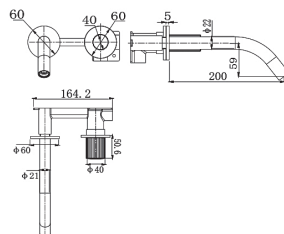

**Ref.: 44112**



Monomando lavabo  
Empotrado sin placa

Basin mixer  
Recessed without plate

Mitigeur lavabo  
Encastré sans plaque

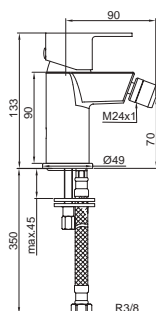

**Ref.: 44227**



Monomando de bidé

Bidet mixer

Mitigeur bidet

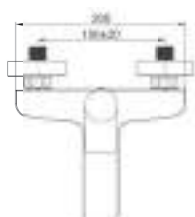
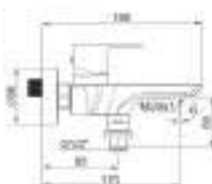

**Ref.: 44555**



Monomando baño ducha

Mixer bath shower

Mitigeur bain douche

**Ref.: 44555/0**

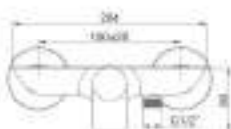
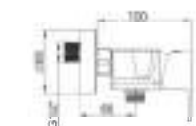

**Ref.: 44124**



Monomando de ducha

Shower mixer

Mitigeur de douche

**Ref.: 44124/0**



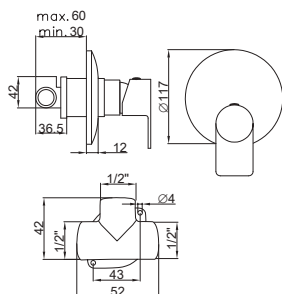

**Ref.: 44425**



Monomando ducha  
empotrado

Concealed bath-shower

Mitigeur douche a encastrer

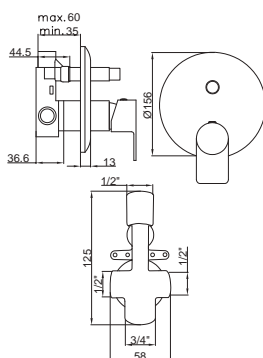

**Ref.: 44556**



Monomando ducha  
empotrado con dos salidas

Concealed bath-shower with two  
outputs

Mitigeur douche a encastrer  
avec deux sorties





**Ref.: Shower Set1**

SHOWER SET1, 2 VIAS  
 Accesorios de ducha para empotrados, incluye brazo pared, rociador, Soporte c/toma, flexo y manual de ducha

SHOWER SET1, 2 WAYS  
 Complete recessed shower kit  
 Includes: wall arm, sprayer, Support w/outlet, hose and shower handle

SHOWER SET1, 2 FAÇONS  
 Kit de douche encastré complet  
 Comprend : bras mural, pulvérisateur, Support avec poignée de douche



**Ref.: Shower Set2**

SHOWER SET2, 2 VIAS  
 Accesorios de ducha para empotrados, incluye brazo pared, rociador, Soporte c/toma, flexo y manual de ducha

SHOWER SET1, 2 WAYS  
 Complete recessed shower kit  
 Includes: wall arm, sprayer, Support w/outlet, hose and shower handle

SHOWER SET1, 2 FAÇONS  
 Kit de douche encastré complet  
 Comprend : bras mural, pulvérisateur, Support avec poignée de douche

# Colección **APOLO**

---

Diseñar un producto, es diseñar una relación.

Designing a product is designing a relationship.

Concevoir un produit, c'est concevoir une relation.

Steve Rogers

---

---



**22 BOET SELECTION**

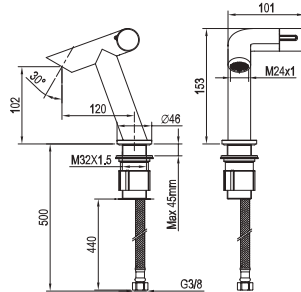

**Ref.: 22107**



Grifo mezclador para lavabo  
Diseño y ahorro con el cartucho progresivo de apertura en frío

Basin Mixer  
Design and savings with the cartridge cold opening progressive

Mitigeur lavabo  
Design et économies avec la cartouche ouverture à froid progressive

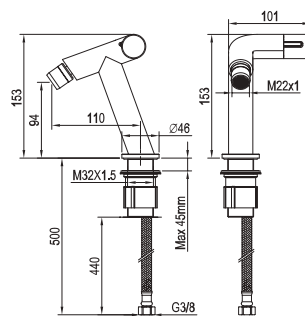

**Ref.: 22227**



Grifo Bidé  
Con rótula giratoria

Bidet mixer  
With rotary ball joint

Mitigeur bidet  
Avec rotule rotative

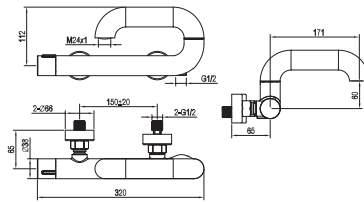

Mezclador baño ducha  
El caño del grifo hace las funciones de inversor quedando integrado

Bath shower mixer  
The faucet spout does the functions of inverter being integrated

Ref.: 22555



Ref.: 22555/0



Mitigeur bain douche  
Le bec du robinet remplit les fonctions de l'onduleur en cours d'intégration

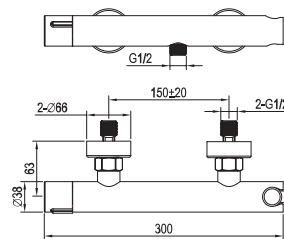

Mezclador ducha  
Soporte del maneral integrado

Shower mixer  
Integrated handle support

Ref.: 22424



Ref.: 22424/0



Mitigeur de douche  
Support de poignée intégré

## Colección **MOON**

---

La perfección se consigue cuando no hay nada más que agregar, pero no hay nada más que quitar.

Perfection is achieved when there is nothing more to add, but there is nothing more to remove.

La perfection est atteinte quand il n'y a plus rien à ajouter, mais il n'y a plus rien à enlever.

Antoine de Saint Exupery

---



**29 BOET SELECTION**



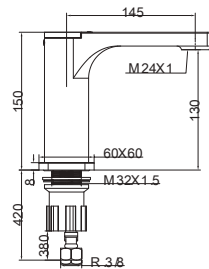

**Ref.: 29107**



Grifo mezclador para lavabo  
Diseño y ahorro con el cartucho  
progresivo de apertura en frío

Basin Mixer  
Design and savings with the  
cartridge cold opening progressive

Mitigeur lavabo  
Design et économies avec la  
cartouche Ouverture à froid  
progressive

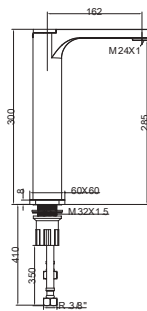

**Ref.: 29109**



Grifo mezclador para lavabo alto  
Indicado para lavabos tipo "bowl"  
con apertura en frío y cartucho  
progresivo

High basin mixer  
Indicated for "bowl" type sinks  
with cold opening progressive

Mitigeur de lavabo haut  
Indiqué pour les éviers de type  
"bol" avec ouverture à froid  
progressive

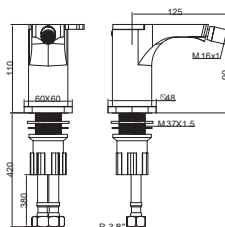

**Ref.: 29227**



Monomando de bidé  
con rótula orientable

Bidet mixer  
with rotary ball joint

Mitigeur bidet  
Avec rotule rotativa

**Ref.: 44424**

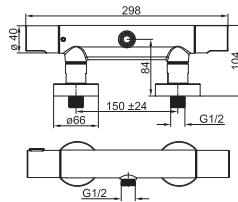

Mezclador termostático de ducha  
Grifo con sistema anti-quemaduras BOET TOUCH

Thermostatic shower mixer  
Faucet with anti-burn system  
BOET TOUCH

Mitigeur thermostatique de douche  
Robinet avec système anti-brûlure  
BOET TOUCH



**Ref.: 4102**



Barra deslizante con ducha

Sliding bar with shower

Barre coulissante avec douche

## Colección **ARES**

---

El que en un arte ha llegado a maestro, puede prescindir de las reglas.

The one who in an art has become a teacher, can dispense with the rules.

Celui qui dans un art est devenu un enseignant, peut se passer des règles.

Arturo Graff

---



**34 BOET SELECTION**



Monomando lavabo  
Aireador orientable integrado

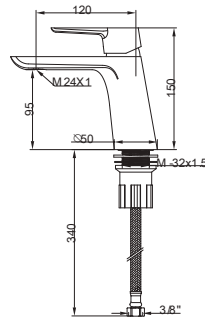

Basin mixer  
Integrated adjustable aerator

**Ref.: 34107**



**Ref.: 34108**



Mitigeur lavabo  
Aérateur réglable intégré



Monomando lavabo negro  
Aireador orientable integrado

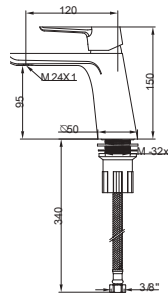

Basin mixer black  
Integrated adjustable aerator

**Ref.: 34107 N**



Mitigeur lavabo noir  
Aérateur réglable intégré



Monomando lavabo blanco  
Aireador orientable integrado

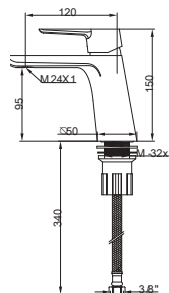

Basin mixer white  
Integrated adjustable aerator

**Ref.: 34107 B**



Mitigeur lavabo blanc  
Aérateur réglable intégré

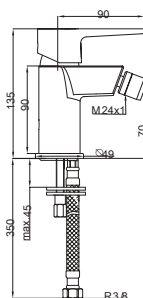

**Ref.: 34227**



**Ref.: 34228**



Monomando de bidé  
Con rótula giratoria

Bidet mixer  
With rotary ball joint

Mitigeur bidet  
Avec rotule rotativa

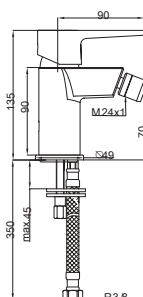

**Ref.: 34227 N**



Monomando de bidé  
Con rótula giratoria

Bidet mixer  
With rotary ball joint

Mitigeur bidet  
Avec rotule rotativa

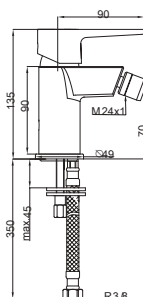

**Ref.: 34227 B**



Monomando de bidé  
Con rótula giratoria

Bidet mixer  
With rotary ball joint

Mitigeur bidet  
Avec rotule rotativa

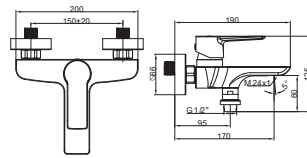

Monomando baño ducha  
Distribuidor integrado  
en la conexión del flexo

Bath shower mixer  
Distributor integrated in the  
shower hose connection

**Ref.: 34555**

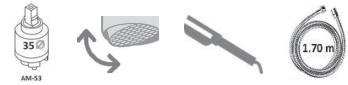

**Ref.: 34555/0**



Mitigeur bain douche  
Distributeur intégré dans le  
raccord de tuyau de douche

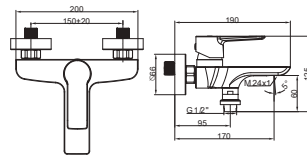

Monomando baño ducha  
Distribuidor integrado  
en la conexión del flexo

Bath shower mixer  
Distributor integrated in the  
shower hose connection

**Ref.: 34555 N**



Mitigeur bain douche  
Distributeur intégré dans le  
raccord de tuyau de douche

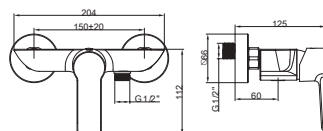

Monomando de ducha

Shower mixer

**Ref.: 34424**



Mitigeur douche



**ARES**

**BOET**



Monomando de ducha

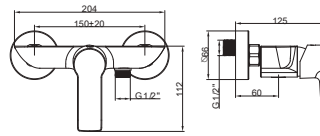

Shower mixer

**Ref.: 34424 N**



Mitigeur douche



Monomando ducha empotrado  
2 vías

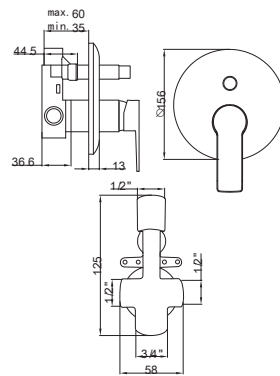

Concealed bath-shower

**Ref.: 34556**



Mitigeur bain douche à encastrer



Monomando ducha empotrado  
2 vías

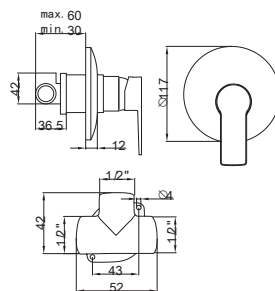

Concealed shower

**Ref.: 34425**



Mitigeur douche à encastrer



**Ref.: Shower Set1**

**SHOWER SET1, 2 VIAS**  
 Accesorios de ducha para empotrados, incluye brazo pared, rociador, Soporte c/toma, flexo y manual de ducha

**SHOWER SET1, 2 WAYS**  
 Complete recessed shower kit  
 Includes: wall arm, sprayer, Support w/outlet, hose and shower handle

**SHOWER SET1, 2 FAÇONS**  
 Kit de douche encastré complet  
 Comprend : bras mural, pulvérisateur, Support avec poignée de douche



**Ref.: Shower Set2**

**SHOWER SET2, 2 VIAS**  
 Accesorios de ducha para empotrados, incluye brazo pared, rociador, Soporte c/toma, flexo y manual de ducha

**SHOWER SET1, 2 WAYS**  
 Complete recessed shower kit  
 Includes: wall arm, sprayer, Support w/outlet, hose and shower handle

**SHOWER SET1, 2 FAÇONS**  
 Kit de douche encastré complet  
 Comprend : bras mural, pulvérisateur, Support avec poignée de douche



Ref.:44431 N

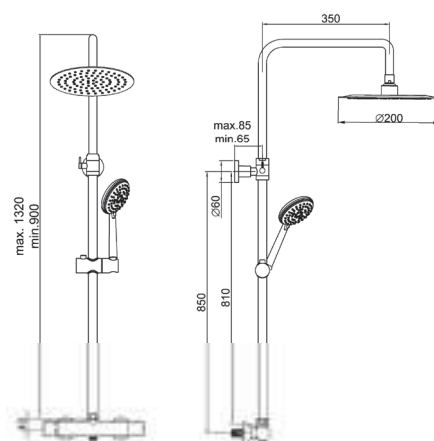

Barra ducha vista  
Equipado con rociador y mango  
de ducha anti-cal

Shower mixer, with fixed view bar  
Equipped with sprinkler and  
Anti-lime shower hand le

Mitigeur douche, avec colonne  
douche  
Équipé d'un asperseur et  
Poignée de douche anticalcaire



# Colección **NEOS**

---

La belleza perece en la vida, pero es inmortal en el arte.

Beauty perishes in life, but it is immortal in art.

La beauté périt dans la vie, mais il est immortel dans l'art.

Leonardo da Vinci

---

---



**94 BOET SELECTION**

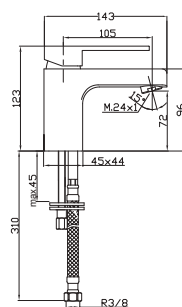

Monomando lavabo

Basin mixer

**Ref.: 94107**



**Ref.: 94108**



Mitigeur lavabo

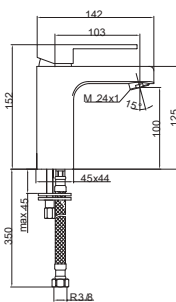

Monomando lavabo alto

High basin mixer

**Ref.: 94109**



**Ref.: 94109/V**



Mitigeur lavabo haut

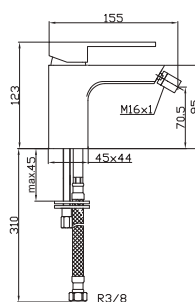

Monomando bidé  
Con rotula giratoria

Bidet mixer  
With rotary ball joint

**Ref.: 94227**



**Ref.: 94228**



Mitigeur bidet  
Avec rotule rotativa

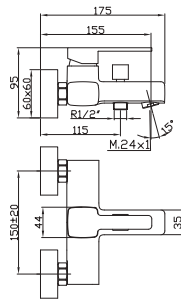

Monomando baño ducha

Bath shower mixer

Ref.: 94555



Ref.: 94555/0



Mitigeur bain douche

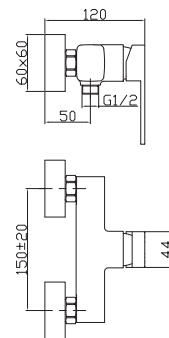

Monomando de ducha

Shower mixer

Ref.: 94424



Ref.: 94424/0



Mitigeur de douche

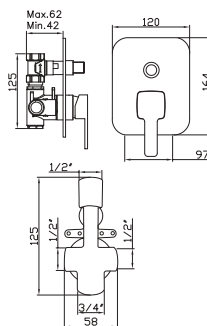

Monomando ducha empotrado  
2 vías

Concealed bath-shower

Ref.: 94556



Mitigeur bain douche à encastrer



Monomando ducha empotrado

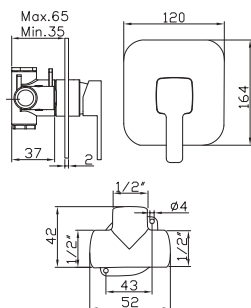

Concealed shower

**Ref.: 94425**



Mitigeur bain douche à encastrer



Grifo mezclador para fregadero

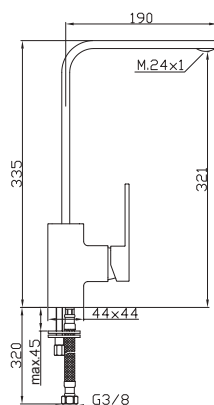

Sink Mixer

**Ref.: 94658**



Mitigeur évier





**Ref.: Shower Set1**

SHOWER SET1, 2 VIAS  
 Accesorios de ducha para empotrados, incluye brazo pared, rociador, Soporte c/toma, flexo y manual de ducha

SHOWER SET1, 2 WAYS  
 Complete recessed shower kit  
 Includes: wall arm, sprayer, Support w/outlet, hose and shower handle

SHOWER SET1, 2 FAÇONS  
 Kit de douche encastré complet  
 Comprend : bras mural, pulvérisateur, Support avec poignée de douche



**Ref.: Shower Set2**

SHOWER SET2, 2 VIAS  
 Accesorios de ducha para empotrados, incluye brazo pared, rociador, Soporte c/toma, flexo y manual de ducha

SHOWER SET1, 2 WAYS  
 Complete recessed shower kit  
 Includes: wall arm, sprayer, Support w/outlet, hose and shower handle

SHOWER SET1, 2 FAÇONS  
 Kit de douche encastré complet  
 Comprend : bras mural, pulvérisateur, Support avec poignée de douche

# Colección **LAST**

---

Las grandes cosas no están hechas por impulso, son un conjunto de pequeñas cosas.

Great things are not made on impulse, They are a set of little things.

Les grandes choses ne sont pas faites sur l'impulsion, Ils sont un ensemble de petites choses.

Vincent Van Gogh

---



**20 BOET SELECTION**

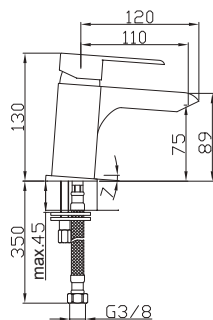

Monomando de lavabo

Basin mixer

Ref.: 20107



Ref.: 20108



Mitigeur lavabo

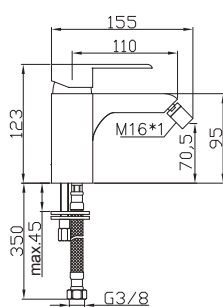

Monomando de bidé

Bidet mixer

Ref.: 20227



Ref.: 20228



Mitigeur bidet

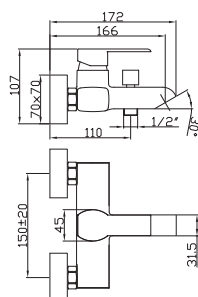

Monomando baño ducha

Exterior mixer tap with bath  
sower selector

Ref.: 20555



Ref.: 20555/0



Mitigeur bain douche avec  
inverseur



Monomando exterior para ducha

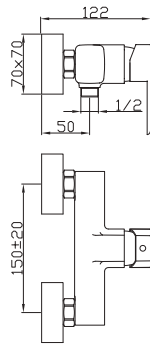

Exterior mixer tap for shower

Ref.: 20424



Ref.: 20424/0



Mitigeur douche



Monomando ducha empotrado 2 vías

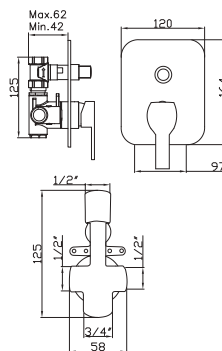

Concealed bath-shower 2 ways

Ref.: 20556



Mitigeur bain douche à encastrer deux sorties



Monomando ducha empotrado

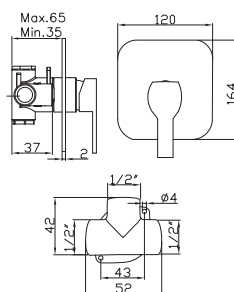

Concealed shower

Ref.: 20425



Mitigeur douche a encastrer

# Colección **OCHO**

---

Un aspecto esencial de la creatividad es no tener miedo a fallar.

An essential aspect of creativity is not afraid to fail.

Un aspect essentiel de la créativité n'a pas peur d'échouer.

Dr. Edwin Land

---



**88 BOET SELECTION**





Grifo mezclador para lavabo

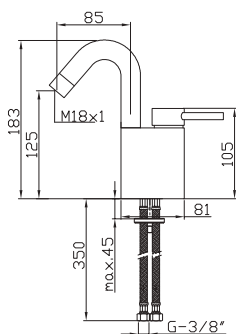

Basin mixer

**Ref.: 88107**



**Ref.: 88108**



Mitigeur lavabo



Grifo mezclador para bidé

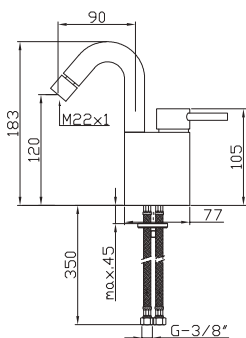

Bidet mixer

**Ref.: 88227**



**Ref.: 88228**



Mitigeur bidet



Mezclador exterior con inversor  
baño ducha

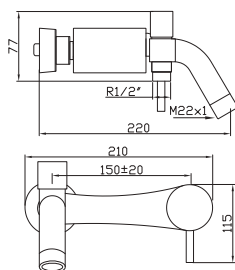

Exterior mixer tap with bath  
sower selector

**Ref.: 88555**



**Ref.: 88555/0**



Mitigeur bain douche avec  
inverseur





# Colección **PRISMA**

---

El Diseño crea cultura. La Cultura moldea valores. Los valores determinan el futuro.

Design creates culture. Culture molds values. The values determine the future.

Le design crée la culture. La culture façonne les valeurs. Les valeurs déterminent le futur.

Robert L. Peters

---



**87 BOET SELECTION**



Monomando de lavabo

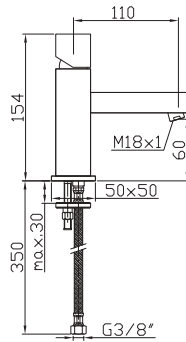

Basin mixer

**Ref.: 87107**



**Ref.: 87108**



Mitigeur lavabo



Monomando de lavabo c/caño giratorio

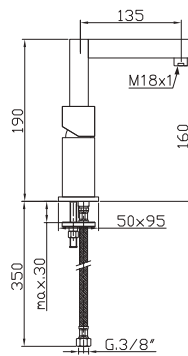

Basin mixer with rotating spout

**Ref.: 87117**



**Ref.: 87118**



Mitigeur lavabo avec bec mobile



Monomando de lavabo Alto

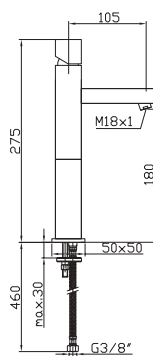

High basin mixer

**Ref.: 87109**



Mitigeur lavabo haut

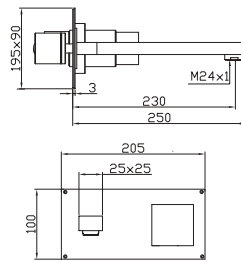

**Ref.: 87110**



Monomando de lavabo empotrado

Concealed Basin Mixer

Mitigeur lavabo à encastrer

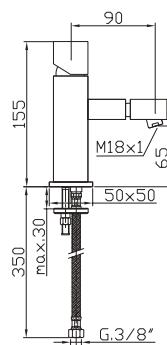

**Ref.: 87227**



**Ref.: 87228**



Monomando de bidé

Bidet mixer

Mitigeur bidet

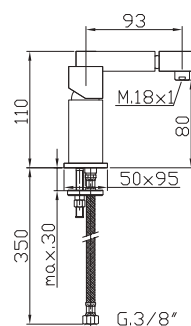

**Ref.: 87337**



**Ref.: 87338**



Monomando de bidé caño giratorio

Bidet mixer with rotating spout

Mitigeur bidet avec bec mobile.

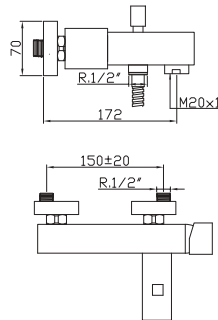

Monomando baño ducha

Shower mixer

**Ref.: 87555**



**Ref.: 87555/0**



Mitigeur bain douche avec inverseur

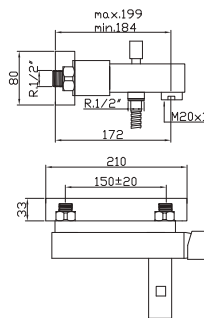

Monomando de baño ducha.  
Con placa rectangular

Exterior mixer tap with bath-shower selector. Whit one rectangular escutcheon

**Ref.: 87557**



Mitigeur bain douche avec inverseur. Avec plaque rectangulaire

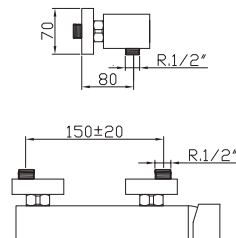

Monomando de ducha

Exterior mixer tap for shower

**Ref.: 87424**



**Ref.: 87424/0**



Mitigeur douche

**PRISMA**

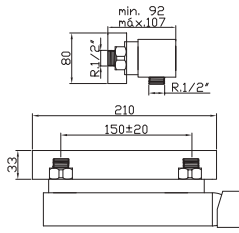

**Ref.: 87427**



Monomando de ducha.  
Con placa rectangular

Exterior mixer tap for shower.  
Whit one rectangular escutcheon

Mitigeur douche.  
Avec plaque rectangulaire

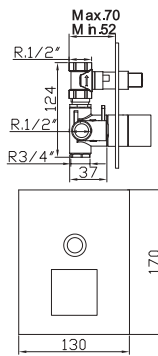

**Ref.: 87556**



Monomando baño ducha  
empotrado

Concealed bath-shower

Mitigeur bain douche à encastrer

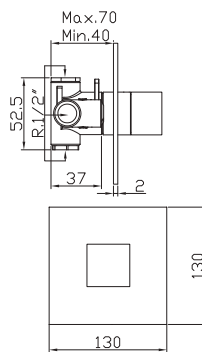

**Ref.: 87425**



Monomando ducha empotrado

Concealed shower

Mitigeur douche a encastrer

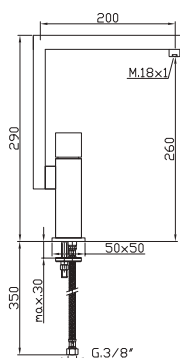

**Ref.: 87658/08**



Grifo mezclador para fregadero de repisa caño fundido

Sink mixer with moulded spout

Mitigeur évier bec haut fondu

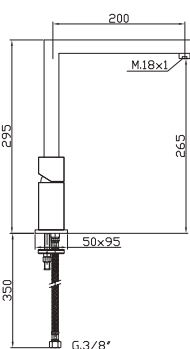

**Ref.: 87659/09**



Grifo mezclador para fregadero de repisa caño fundido

Sink mixer with moulded spout

Mitigeur évier bec haut fondu

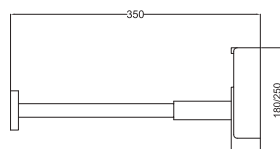

**Ref.: 4036**

Sifón cuadrado visto extensible

Square and mounted siphon with extended rod

Siphon carré vu, extensible



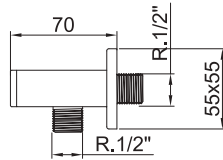

**Ref.: 4046**

Soporte mango ducha con toma de agua

Shower head bracket with water supply point

Support pour douchette avec prise d'eau

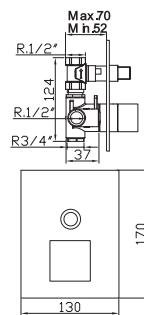

**Ref.: 4029**

Llave de corte de 1/2 - 3/8

Wall mounted fauced

Robinet d'arret

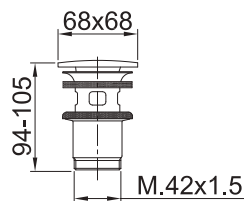

**Ref.: 4034**

Desagüe pulsador rapid cuadrado

Square quick clac pop-waste

Vidage Quic Clac carré

# Colección **TUBULAR**

---

El estilo es un modo de decir quien eres, sin la necesidad de hablar.

Style is a way of saying who you are, without the need to talk.

**Le style est une façon de dire qui vous êtes, sans avoir besoin de parler.**

Rachel Zoe

---



---

**82 BOET SELECTION**

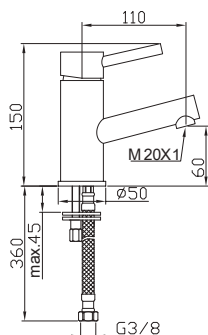

**Ref.: 82107**



**Ref.: 82108**



Grifo mezclador para lavabo

Basin mixer

Mitigeur lavabo

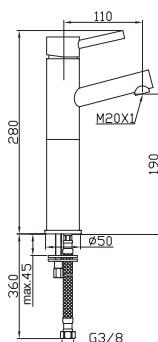

**Ref.: 82109**



**Ref.: 82109/V**



Grifo mezclador para lavabo Alto

High basin mixer

Mitigeur lavabo haut

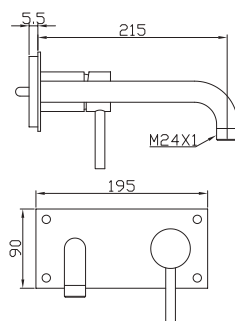

**Ref.: 82110**



Grifo mezclador para lavabo empotrado

Concealed basin mixer

Mitigeur lavabo à encastrer

# TUBULAR

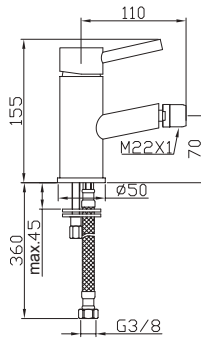

**Ref.: 82227**



**Ref.: 82228**



Grifo mezclador para bidé

Bidet mixer

Mitigeur bidet

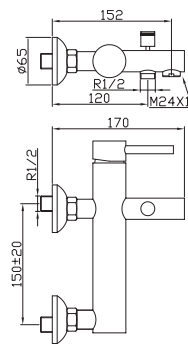

**Ref.: 82555**



**Ref.: 82555/0**



Mezclador exterior con inversor baño ducha

Exterior mixer tap with bath shower selector

Mitigeur bain douche avec inverseur

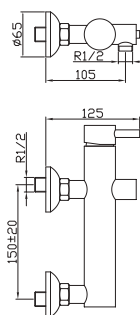

**Ref.: 82424**



**Ref.: 82424/0**



Mezclador exterior para ducha

Exterior mixer tap for shower

Mitigeur douche



Monomando ducha empotrado 2 vías

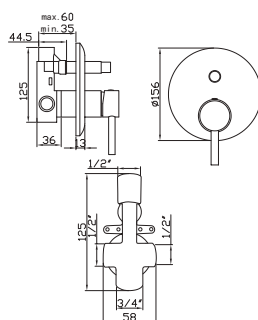

Concealed bath-shower 2 ways

**Ref.: 82556**



Mitigeur bain douche à encastrer deux sorties



Monomando ducha empotrado

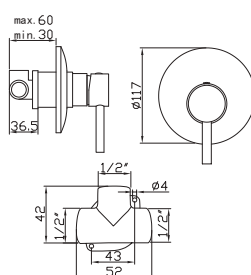

Concealed shower

**Ref.: 82425**



Mitigeur douche a encastrer



Con rociador INOX de 3 mm. d 20

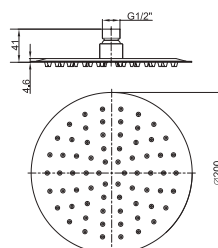

INOX shower sprayer 3 mm. d 20

**Ref.: 4084**

Asperseur INOX 3 mm. d 20

# TUBULAR

Ref.: 4013

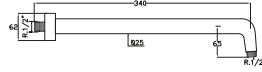

Brazo de ducha fijo

Fixed shower arm

Bras de douche fixe

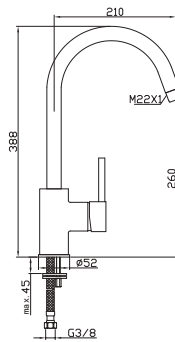

Ref.: 82657/07



Grifo mezclador para fregadero de repisa caño de tubo

Sink mixer with formed spout

Mitigeur évier bec mobile haut tube

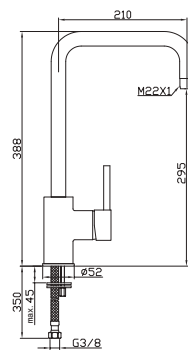

Ref.: 82858/08



Grifo mezclador para fregadero de repisa caño de tubo recto

Sink mixer with moulded spout

Mitigeur évier bec haut fondu

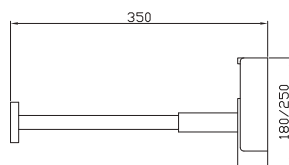
**Ref.: 4023**

Sifón cilíndrico visto extensible

Cilindric and mounted siphon with extended rod

Siphon cylindrique vu, extensible

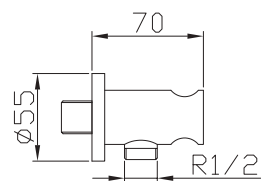
**Ref.: 4047**

Soporte mango ducha con toma de agua

Shower head bracket with water supply point

Support pour douchette avec prise d'eau

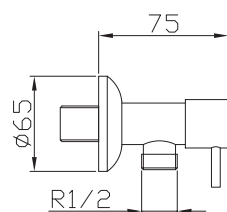
**Ref.: 4022**

Llave de corte de 1/2 - 3/8

Wall mounted fauced

Robinet d'arret





Desagüe pulsador rapid

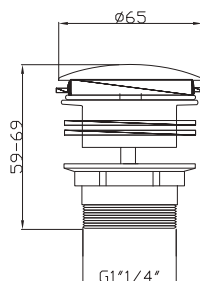

Square quick clac pop-waste

Ref.: 4025

Vidage Quic Clac



Desagüe automatico metálico visto, con cuerpo cilíndrico

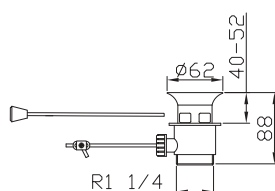

Metallic pop-up waste mounted with cylindric head

Ref.: 4024

Vidage automatique metallique vu, avec corps cylindrique

# Colección **DUO**

---

Cualquier tecnología suficientemente avanzada es equivalente a la magia.

Any technology enough advanced is equivalent to magic.

Toute technologie assez avancé est équivalent à la magie.

Sir Arthur C. Clarke

---

---



**25 BOET SELECTION**

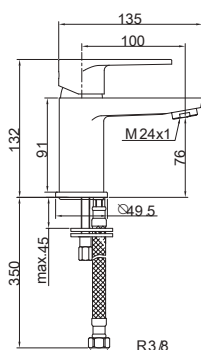

Grifo mezclador para lavabo

Basin mixer

Ref.: 25107



Mitigeur lavabo

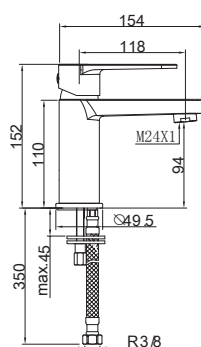

Grifo mezclador para lavabo alto

High basin mixer

Ref.: 25109



Mitigeur lavabo élevé

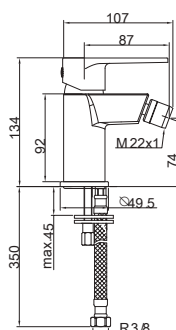

Grifo mezclador para bidé

Bidet mixer

Ref.: 25227



Mitigeur bidet

# DUO

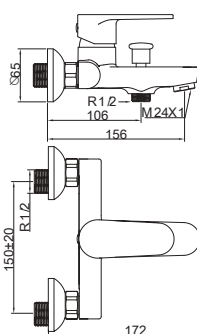

Ref.: 25555



Ref.: 25555/0



Mezclador exterior con inversor baño ducha

Exterior mixer tap with bath sower selector

Mitigeur bain douche avec inverseur

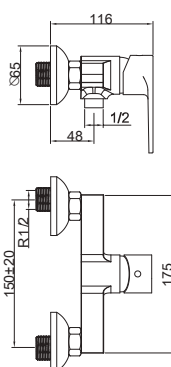

Ref.: 25424



Ref.: 25424/0



Mezclador exterior para ducha

Exterior mixer tap for shower

Mitigeur douche



Monomando ducha empotrado

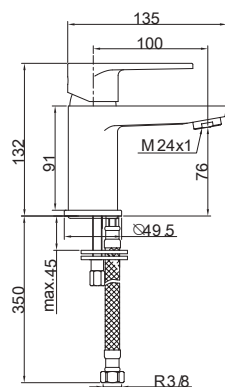

Concealed shower

Ref.: 25425



Mitigeur douche a encastrer



Monomando baño ducha empotrado

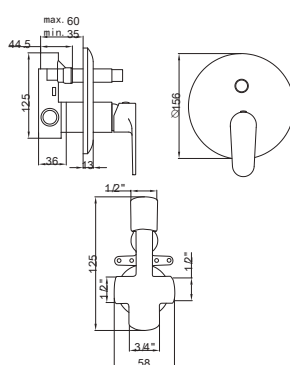

Concealed bath-shower

Ref.: 25556



Mitigeur bain douche à encastrer



**Ref.: Shower Set2**

**SHOWER SET2, 2 VIAS**  
 Accesorios de ducha para empotrados, incluye brazo pared, rociador, Soporte c/toma, flexo y manual de ducha

**SHOWER SET1, 2 WAYS**  
 Complete recessed shower kit  
 Includes: wall arm, sprayer, Support w/outlet, hose and shower handle

**SHOWER SET1, 2 FAÇONS**  
 Kit de douche encastré complet  
 Comprend : bras mural, pulvérisateur, Support avec poignée de douche



Grifo mezclador para fregadero

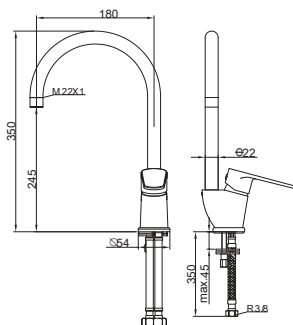

Sink Mixer

**Ref.: 25657**



Mitigeur évier



# ECO BOET





ICE  
JET  
LUCA

ECO BOEIT

# Colección **ICE**

---

El agua es el elemento y principio de las cosas.

Water is the element and principle of things.

L'eau est l'élément et le principe des choses.

Tales de Mileto

---

---



**26 ECO BOET**

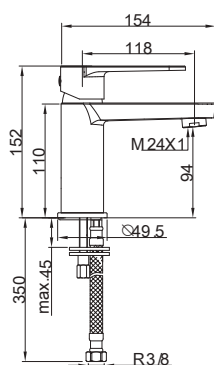

Grifo mezclador para lavabo

Basin mixer

Ref.: 26107



Ref.: 26108



Mitigeur lavabo

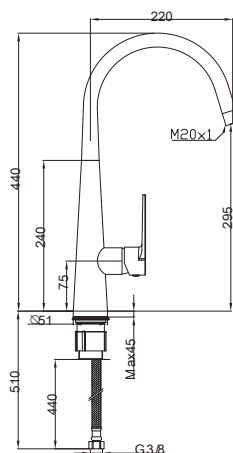

Grifo mezclador para fregadero

Sink Mixer

Ref.: 26659



Mitigeur évier

ICE

**BOET**

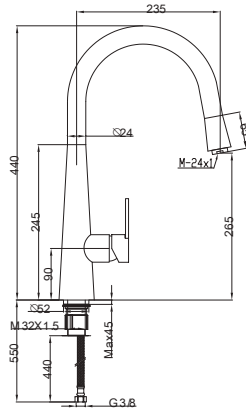

**Ref.: 26681**



Grifo mezclador para fregadero con ducha extraíble

Sink Mixer with shower head

Mitigeur évier avec douchette

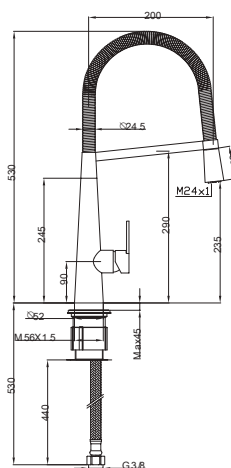

**Ref.: 26692**



Grifo mezclador para fregadero con muelle extensible

Sink Mixer with extending spring

Mitigeur évier avec ressort d'extension

# Colección **JET**

---

La belleza es el acuerdo entre el contenido y la forma.

Beauty is the agreement between the content and form it.

La beauté est l'accord entre le contenu et le former.

Henrik Johan Ibsen

---

---



**96 ECO BOET**

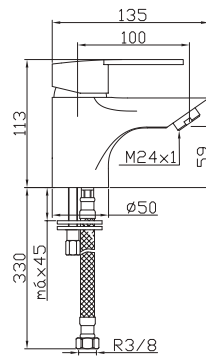

Monomando lavabo  
Grifería con certificado de calidad medioambiental

Basin mixer  
Faucet with environmental quality certificate

Ref.: 96107



Ref.: 96108



Mitigeur lavabo  
Robinet avec certificat de qualite environnementale

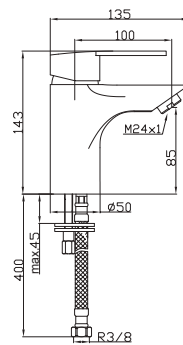

Monomando lavabo alto  
Grifería con certificado de calidad medioambiental

Basin mixer hight  
Faucet with environmental quality certificate

Ref.: 96109



Ref.: 96109/V



Mitigeur lavabo haute  
Robinet avec certificat de qualite environnementale

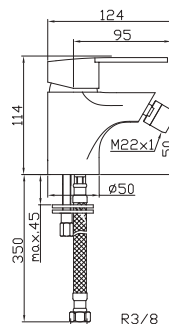

Monomando bidé

Bidet mixer

Ref.: 96227



Ref.: 96228



Mitigeur bidet



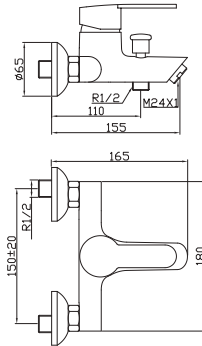

Ref.: 96555



Ref.: 96555/0



Mezclador exterior con inversor  
baño ducha

Exterior mixer tap with bath  
sower selector

Mitigeur bain douche avec  
inverseur

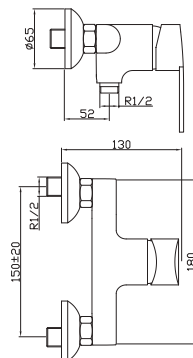

Ref.: 96424



Ref.: 96424/0



Mezclador exterior para ducha  
Robinet avec certificat de  
qualite environnementale

Exterior mixer tap for shower  
Faucet with enviromental  
quality certificate

Mitigeur douche  
Robinet avec certificat de  
qualite environnementale

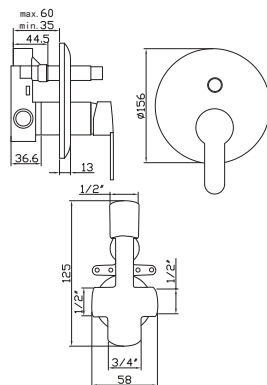

Ref.: 96556



Monomando ducha empotrado 2 vías

Concealed bath-shower 2 ways

Mitigeur bain douche à encastrer deux sorties

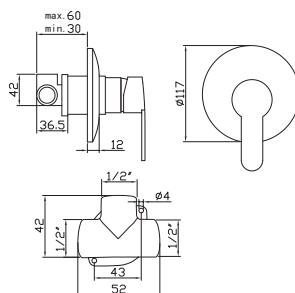

Ref.: 96425



Monomando ducha empotrado

Concealed shower

Mitigeur douche a encastrer

# JET



Barra vista ducha monomando.  
Mango anti cal 3 posiciones.  
Rociador ANTI-CAL ABS

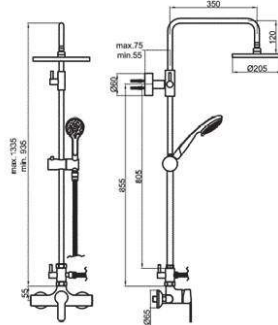

Shower mixer tap with shower  
column. ABS

Ref.: 96430/C



Melangeur pour douche mural avec  
colonne de douche. ABS



Mezclador monomando,  
telescópico para ducha  
JET. Mango ANTI-CAL de 3  
posiciones. Rociador cuadrado  
ANTI-CAL, INOX 3 mm

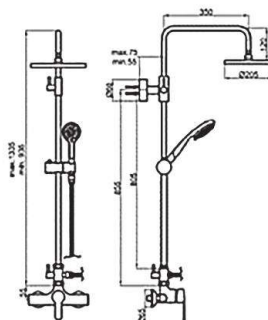

Shower mixer tap with shower  
column JET

Ref.: 96430/2



Melangeur pour douche mural  
avec colonne de douche JET



Barra vista ducha monomando. Mango ANTI-CAL de 3 posiciones. Rociador ANTI-CAL INOX de 3 mm



Shower mixer tap with shower column JET INOX shower sprayer 3 mm

Ref.: 96430/3



Mélangeur pour douche mural avec colonne de douche JET Asperseur INOX 3 mm



Grifo mezclador para fregadero repisa con caño giratorio inclinado y extraíble

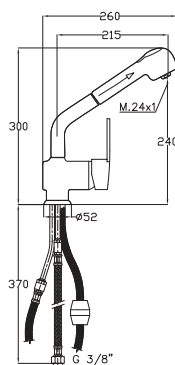

Mixer tap for sink with swivel spout inclined and removable

Ref.: 96670



Mélangeur pour évier avec bec pivotant incliné et amovible

JET

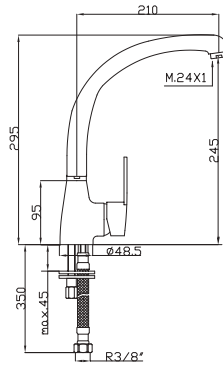

Ref.: 96658



Grifo mezclador para fregadero de repisa con caño conformado

Sink mixer with moulded spout

Mitigeur évier bec haut

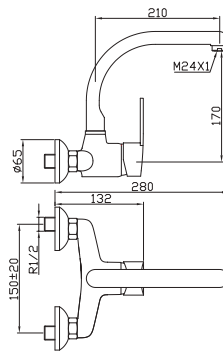

Ref.: 96651



Grifo mezclador para fregadero mural con caño conformado

Sink mixer with formed spout

Mitigeur évier bec mobile haut fondu

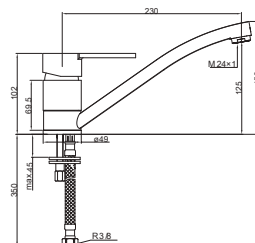

Ref.: 96660



Grifo mezclador para fregadero con caño inclinado

Sink mixer tap with cast molded spout

Robinet mitigeur d'évier avec bec moulé moulé

# Colección **LUCA**

---

No se aprecia el valor del agua hasta que se seca el pozo”

The value of water is not appreciated until the well dries up

“La valeur de l’eau n’est appréciée que lorsque le puits s’assèche “

---

---



**14 ECO BOET**



Monomando lavabo  
Grifería con certificado de calidad medioambiental

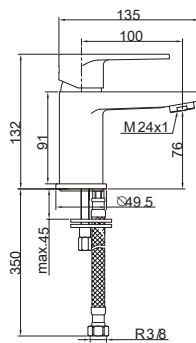

Basin mixer  
Faucet with environmental quality certificate

Ref.: 14107



Ref.: 14108



Mitigeur lavabo  
Robinet avec certificat de qualite environnementale



Monomando lavabo alto  
Grifería con certificado de calidad medioambiental

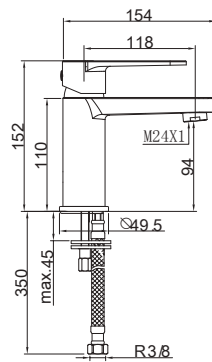

Basin mixer hight  
Faucet with environmental quality certificate

Ref.: 14109



Mitigeur lavabo haute  
Robinet avec certificat de qualite environnementale



Monomando lavabo XXL  
Grifo para lavabos "bowl"

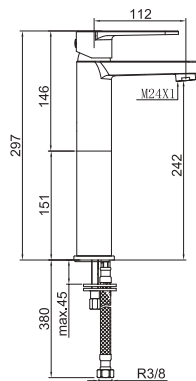

Basin mixer XXL  
Tap for sinks "bowl"

Ref.: 14111



Mitigeur lavabo  
Robinet avec certificat de qualite environnementale



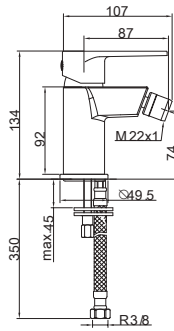

Grifo mezclador para bidé

Bidet mixer

Ref.: 14227



Ref.: 14228



Mitigeur bidet

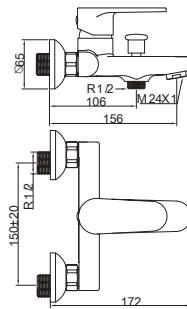

Mezclador exterior con inversor baño ducha

Exterior mixer tap with bath sower selector

Ref.: 14555



Ref.: 14555/0



Mitigeur bain douche avec inverseur

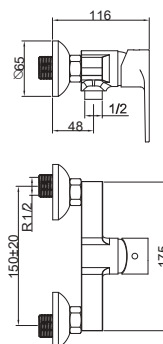

Mezclador exterior para ducha  
Grifería con certificado de calidad medioambiental

Exterior mixer tap for shower  
Faucet with environmental quality certificate

Ref.: 14424



Ref.: 14424/0



Mitigeur douche  
Robinet avec certificat de qualite environnementale

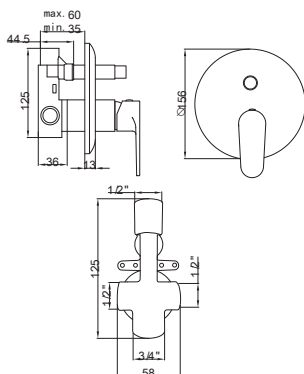

**Ref.: 14556**



Monomando baño ducha empotrado

Concealed bath-shower

Mitigeur bain douche à encastrer

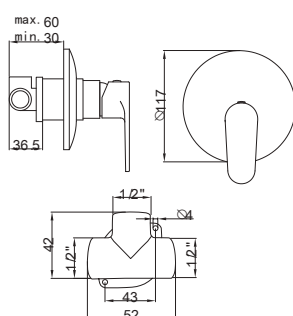

**Ref.: 14425**



Monomando ducha empotrado

Concealed shower

Mitigeur douche a encastrer



**Ref.: Pack LUCA**

Pack LUCA, 2 VIAS  
Grifería de ducha empotrada 2 vías con accesorios: brazo de pared, rociador redondo de 20 cm, soporte con toma de agua, flexo y maneral de ducha

Pack LUCA, 2 WAYS  
2-way recessed shower mixer with accessories: wall arm, 20 cm round shower head, support with water connection, hose and shower handle

Pack LUCA, 2 FAÇONS  
Mitigeur de douche à encastrer 2 sorties avec accessoires: bras mural, pomme de douche ronde 20 cm, support avec raccord d'eau, flexible et poignée de douche



Rociador ABS anticalcareo

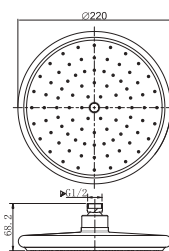

Shower sprayer ABS anti-calcareus

**Ref.: 4082**



Asperseur ABS anticalcaire



Brazo de ducha fijo

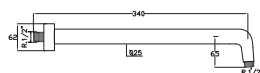

Fixed shower arm

**Ref.: 4013**

Bras de douche fixe

**Ref.: 14430**

Mezclador exterior para ducha,  
con barra vista fija

Shower mixer, with fixed view bar

Mitigeur de douche d'extérieur,  
avec colonne de douche



Grifo mezclador para fregadero  
Grifería con certificado de calidad medioambiental

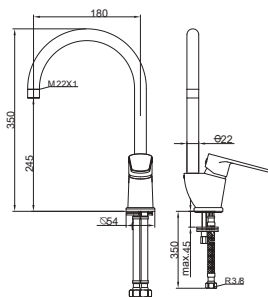

Sink mixer  
Faucet with environmental quality certificate

Ref.: 14657



Mitigeur évier  
Robinet avec certificat de qualite environnementale



# BOET PROFESSIONAL





URBAN  
CITY  
TRIANO MX  
BACK  
PLAY  
SIES  
CINCO  
LINK

**BOET PROFESSIONAL**

# Colección **URBAN**

---

El futuro pertenece a aquellos que creen en la belleza de sus sueños.

The future belongs to those who believe in the beauty of your dreams.

L'avenir appartient à ceux qui croient dans la beauté de tes rêves.

Eleanor Roosevelt

---





**93 BOET PROFESSIONAL**



Grifo mezclador para lavabo

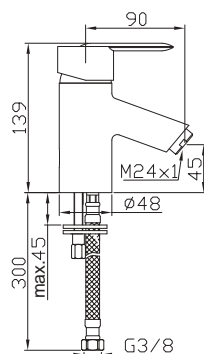

Basin mixer

**Ref.: 93107****Ref.: 93108**

Mitigeur lavabo



Grifo mezclador para bidé

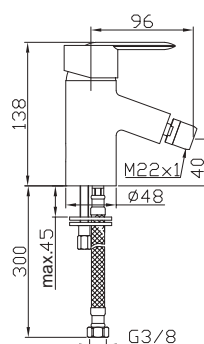

Bidet mixer

**Ref.: 93227****Ref.: 93228**

Mitigeur bidet

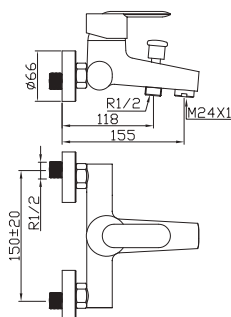

**Ref.: 93555**



**Ref.: 93555/0**



Mezclador exterior con inversor  
baño ducha

Exterior mixer tap with bath  
sower selector

Mitigeur bain douche avec  
inverseur

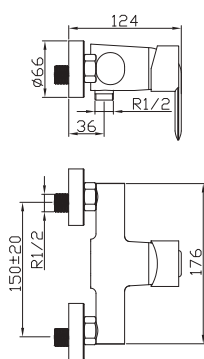

**Ref.: 93424**



**Ref.: 93424/0**



Mezclador exterior para ducha

Exterior mixer tap for shower

Mitigeur douche

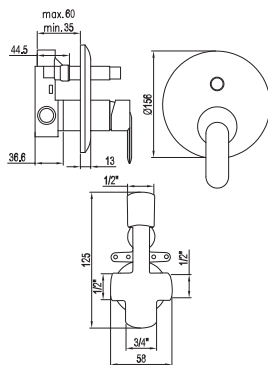

**Ref.: 93556**



Monomando baño ducha empotrado

Concealed bath-shower

Mitigeur bain douche à encastrer

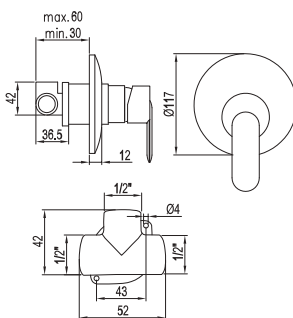

**Ref.: 93425**



Monomando ducha empotrado

Concealed shower

Mitigeur douche a encastrer

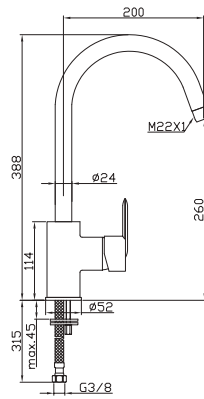

**Ref.: 93657/07**



Grifo mezclador para fregadero de repisa con caño de tubo

Sink mixer with formed spout

Mitigeur évier bec mobile haut tube

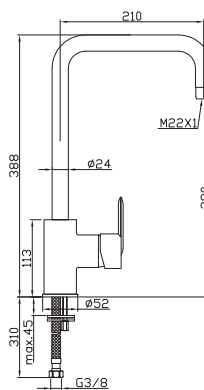

**Ref.: 93658/08**



Grifo mezclador para fregadero de repisa con caño de tubo

Sink mixer with formed spout

Mitigeur évier bec mobile haut tube

# Colección **CITY**

---

Lo bueno necesita aportar pruebas, lo bello no.

The good needs to provide evidence, the beautiful does not.

Le bien a besoin de fournir des preuves, la belle ne le fait pas.

Bernard de Bouvier de Fontanelle

---

---



**97 BOET PROFESSIONAL**



Grifo mezclador para lavabo

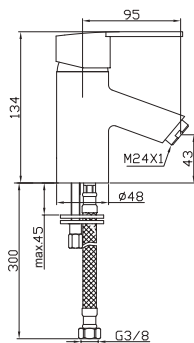

Basin mixer

Ref.: 97107



Ref.: 97108



Mitigeur lavabo



Grifo mezclador para bidé

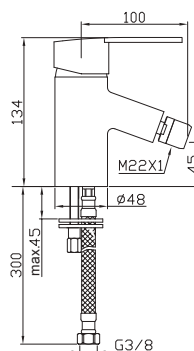

Bidet mixer

Ref.: 97227



Ref.: 97228



Mitigeur bidet



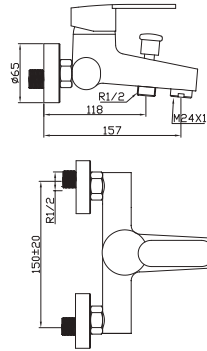

Mezclador exterior con inversor  
baño ducha

Exterior mixer tap with bath  
sower selector

Ref.: 97555



Ref.: 97555/0



Mitigeur bain douche avec  
inverseur

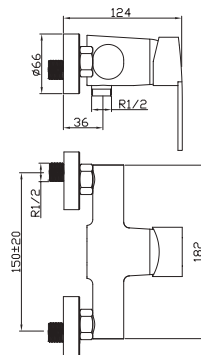

Mezclador exterior para ducha

Exterior mixer tap for shower

Ref.: 97424



Ref.: 97424/0



Mitigeur douche

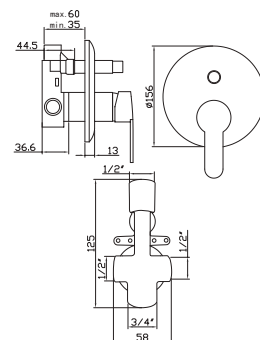

Ref.: 97556



Monomando baño ducha empotrado

Concealed bath-shower

Mitigeur bain douche à encastrer

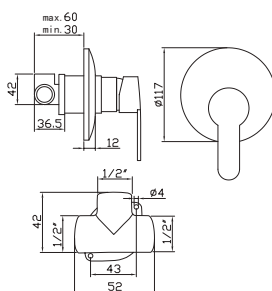

Ref.: 97425



Monomando ducha empotrado

Concealed shower

Mitigeur douche a encastrer

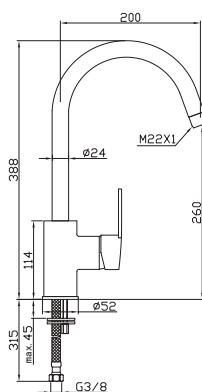

Ref.: 97657



Grifo mezclador para fregadero de repisa con caño de tubo

Sink mixer with formed spout

Mitigeur évier bec mobile haut tube

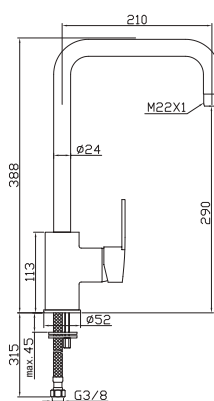

Ref.: 97658



Grifo mezclador para fregadero de repisa con caño de tubo

Sink mixer with formed spout

Mitigeur évier bec mobile haut tube

Colección **TRIANON**  
**MX**

---

La simplicidad es acerca de sustraer lo obvio y añadir lo significativo.

Simplicity is about subtracting the obvious and add the significant.

La simplicité consiste à soustraire l'évidence et ajouter l'important.

John Maeda

---



**80 BOET PROFESSIONAL**

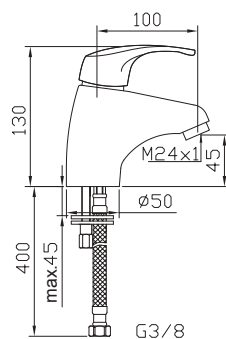

Grifo mezclador para lavabo

Basin mixer

Ref.: 80107MX



Ref.: 80108MX



Mitigeur lavabo

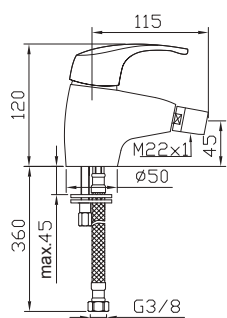

Grifo mezclador para bidé

Bidet mixer

Ref.: 80227MX



Ref.: 80228MX



Mitigeur bidet

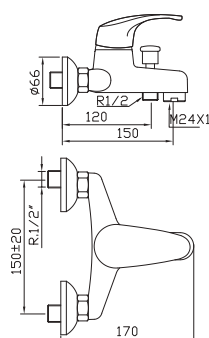

Mezclador exterior con inversor baño ducha

Exterior mixer tap with bath shower selector

Ref.: 80555MX



Ref.: 80555/0MX



Mitigeur bain douche avec inverseur

# TRIANON MX

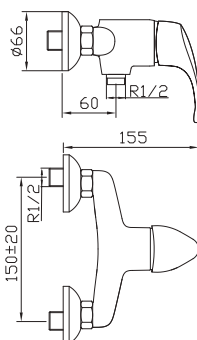

Mezclador exterior para ducha

Exterior mixer tap for shower

Ref.: 80424MX



Ref.: 80424/0MX



Mitigeur douche

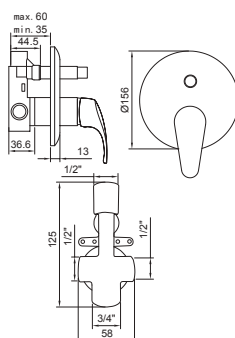

Monomando baño ducha empotrado

Concealed bath-shower

Ref.: 80556MX



Mitigeur bain douche à encastrer

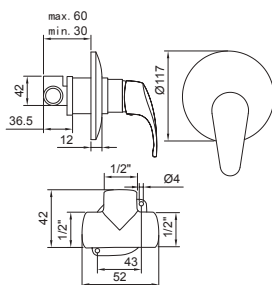

Monomando ducha empotrado

Concealed shower

Ref.: 80425MX



Mitigeur douche a encastrer



Barra vista ducha monomando, con barra vista telescópica

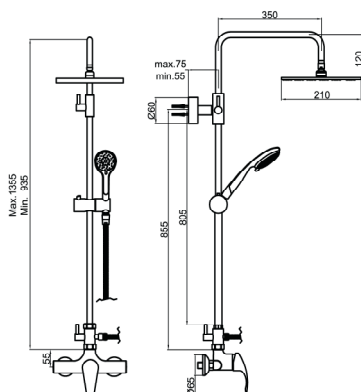

Shower mixer with sliding shower

Ref.: 80430/C MX



Mitigeur pour douche avec colonne de douche



Grifo mezclador para fregadero de repisa con caño fundido

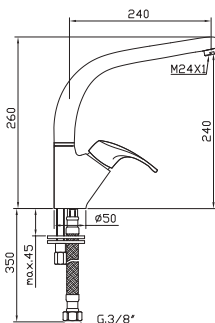

Sink mixer with moulded spout

Ref.: 80658MX



Mitigeur évier bec mobile haut fondu





Grifo mezclador para fregadero mural con caño fundido

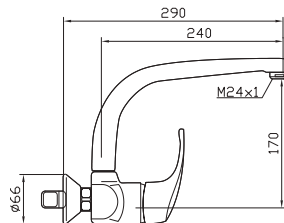

Wall sink mixer with moulded spout

**Ref.: 80652MX**



Mitigeur évier mural bec fondu



Grifo mezclador para fregadero repisa caño giratorio extraible

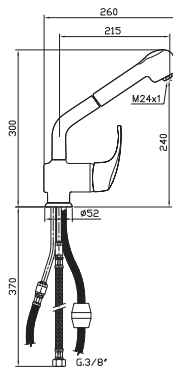

Sink mixer tap with removable swivel spout

**Ref.: 80670MX**



Mitigeur d'évier avec bec mobile

# Colección **BACK**

---

La belleza es muy superior al genio. No necesita explicación.

The beauty is far superior to genius. It does not need explanation.

La beauté est de loin supérieure au génie. Il n'a pas besoin d'explication.

Oscar Wilde

---

---



**21 BOET PROFESSIONAL**

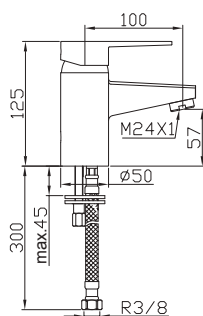

Grifo mezclador para lavabo

Basin mixer

Ref.: 21107



Ref.: 21108



Mitigeur lavabo

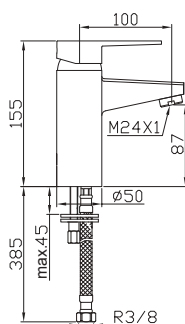

Grifo mezclador para lavabo alto

High basin mixer

Ref.: 21109



Ref.: 21109/V



Mitigeur lavabo élevé

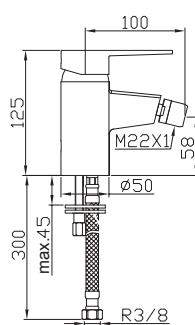

Grifo mezclador para bidé

Bidet mixer

Ref.: 21227



Ref.: 21228



Mitigeur bidet

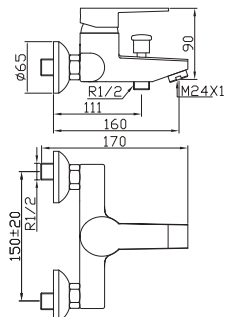

Mezclador exterior con inversor  
baño ducha

Exterior mixer tap with bath  
sower selector

Ref.: 21555



Ref.: 21555/0



Mitigeur bain douche avec  
inverseur

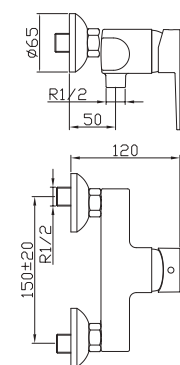

Mezclador exterior para ducha

Exterior mixer tap for shower

Ref.: 21424



Ref.: 21424/0



Mitigeur douche





**Ref.: Shower Set1**

SHOWER SET1, 2 VIAS  
 Accesorios de ducha para empotrados, incluye brazo pared, rociador, Soporte c/toma, flexo y manual de ducha

SHOWER SET1, 2 WAYS  
 Complete recessed shower kit  
 Includes: wall arm, sprayer, Support w/outlet, hose and shower handle

SHOWER SET1, 2 FAÇONS  
 Kit de douche encastré complet  
 Comprend : bras mural, pulvérisateur, Support avec poignée de douche



**Ref.: Shower Set2**

SHOWER SET2, 2 VIAS  
 Accesorios de ducha para empotrados, incluye brazo pared, rociador, Soporte c/toma, flexo y manual de ducha

SHOWER SET1, 2 WAYS  
 Complete recessed shower kit  
 Includes: wall arm, sprayer, Support w/outlet, hose and shower handle

SHOWER SET1, 2 FAÇONS  
 Kit de douche encastré complet  
 Comprend : bras mural, pulvérisateur, Support avec poignée de douche

# Colección **PLAY**

---

El verdadero progreso es el que pone la tecnología al alcance de todos.

The real progress is the one that puts the technology available to everyone.

Le vrai progrès est celui qui met la technologie à la disposition de tous.

Henry Ford

---

---





**98 BOET PROFESSIONAL**

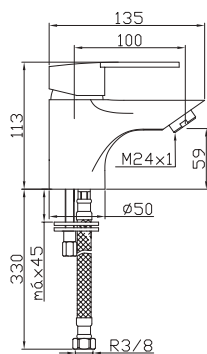

Ref.: 98107



AM-25

Ref.: 98108



AM-25

Ref.: 98102



AM-25

Ref.: 98103



AM-25



Válvula latón  
Brass valve  
Vanne a laton

Grifo mezclador para lavabo

Basin mixer

Mitigeur lavabo

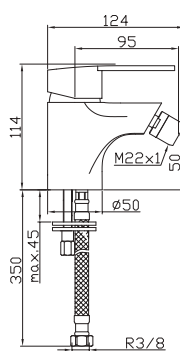

Ref.: 98227



AM-25

Ref.: 98228



AM-25



Grifo mezclador para bidé

Bidet mixer

Mitigeur bidet

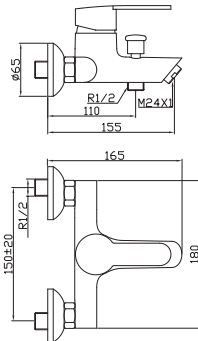

Mezclador exterior con inversor  
baño ducha

Exterior mixer tap with bath  
sower selector

Ref.: 98555



Ref.: 98555/0



Ref.: 98550



Mitigeur bain douche avec  
inverseur

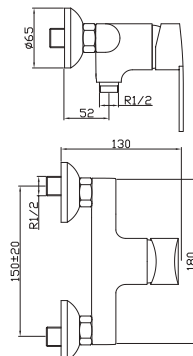

Mezclador exterior de ducha

Exterior mixer tap for shower

Ref.: 98424



Ref.: 98424/0



Ref.: 98420



Mitigeur douche

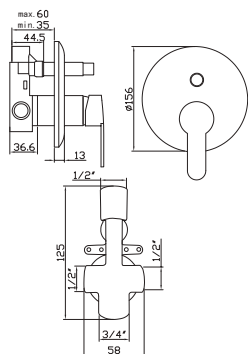

Ref.: 98556



Monomando baño ducha empotrado

Concealed bath-shower

Mitigeur bain douche à encastrer

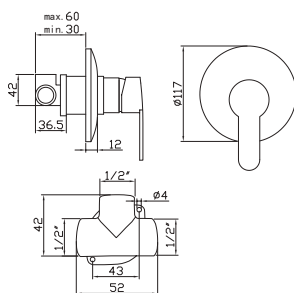

Ref.: 98425



Monomando ducha empotrado

Concealed shower

Mitigeur douche a encastrer

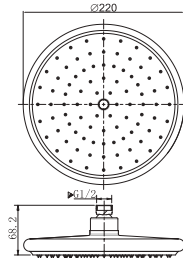

**Ref.: 4082**



Rociador ABS anticalcáreo

Shower sprayer ABS anti-calcareus

Asperseur ABS anticalcaire

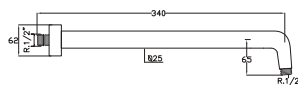

**Ref.: 4013**

Braço de ducha fijo

Fixed shower arm

Bras de douche fixe

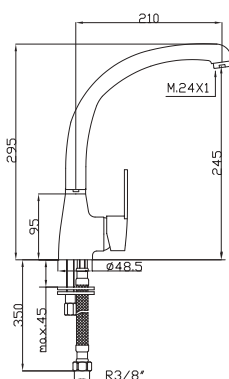

Ref.: 98658



Mitigeur évier bec mobile haut type fondu

Grifo mezclador para fregadero caño conformado

Sink Mixer with formed spout

Ref.: 98660



Mitigeur pour évier, bec orientable

Mixer tap for shelf sink, inclined swivel spout

Grifo mezclador para fregadero de repisa, caño giratorio inclinado

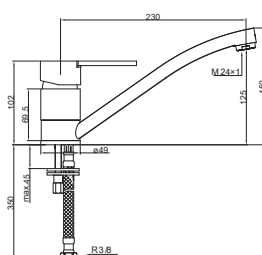



# Colección **SEIS**

---

La belleza complace a los ojos; la dulzura encadena el alma.

Beauty pleases the eyes; the sweetness chains the soul.

La beauté plaît aux yeux; la douceur enchaîne l'âme.

Voltaire

---

---



A large, white, stylized number '6' is positioned on the left side of the image. To its right, there is a dynamic splash of water with numerous bubbles and ripples, set against a dark, almost black background. The lighting highlights the textures of the water and the smooth surface of the number.

---

**66 BOET PROFESSIONAL**



Grifo mezclador para lavabo

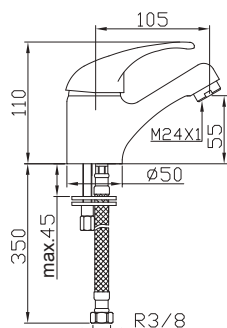

Basin mixer

Ref.: 66107



Ref.: 66108



Mitigeur lavabo



Grifo mezclador para bidé

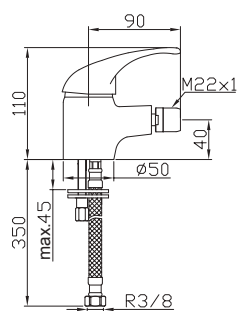

Bidet mixer

Ref.: 66227



Ref.: 66228



Mitigeur bidet

# SEIS

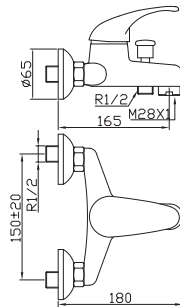

Mezclador exterior con inversor baño ducha

Exterior mixer tap with bath sower selector

Ref.: 66555



Ref.: 66555/0



Mezclador exterior para ducha

Exterior mixer tap for shower

Mitigeur douche

Ref.: 66424



Ref.: 66424/0



Grifo mezclador para fregadero, con caño fundido

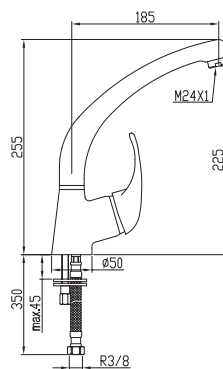

Sink mixer

Ref.: 66659/09



# Colección **CINCO**

---

La simplicidad no es la meta. Es el producto de una buena idea y modestas expectativas.

Simplicity is not the goal. It is the product of a good idea and modest expectations.

La simplicité n'est pas le but. C'est le produit d'une bonne idée et d'attentes modestes.

Paul Rand

---

---



**65 BOET PROFESSIONAL**

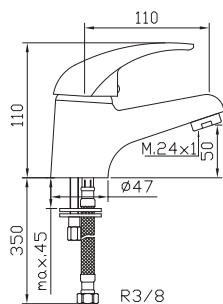

Grifo mezclador para lavabo

Basin mixer

**Ref.: 65107**



**Ref.: 65108X**

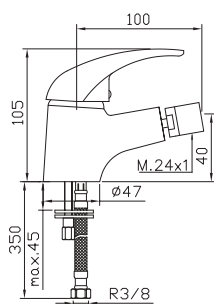

Grifo mezclador para bidé

Bidet mixer

**Ref.: 65227**



**Ref.: 65228**

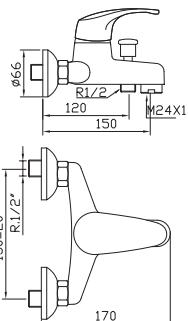

Mezclador exterior con inversor  
baño ducha

Exterior mixer tap with bath  
sower selector

**Ref.: 65555**



**Ref.: 65555/0**



Mitigeur bain douche avec  
inverseur



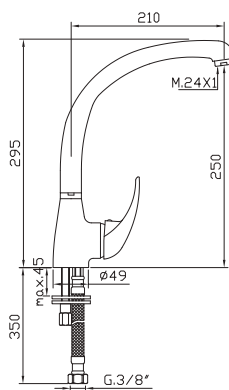

**Ref.: 65658/08**



Grifo mezclador para fregadero de repisa caño de tubo conformado

Sink mixer with formed spout

Mitigeur évier bec mobile haut tube

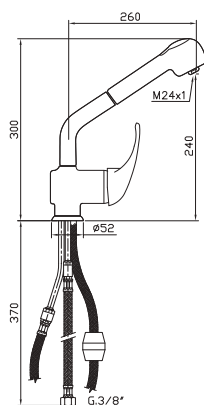

**Ref.: 65670**



Grifo mezclador para fregadero repisa caño giratorio extraíble

Sink mixer tap with removable swivel spout

Mitigeur d'évier avec bec mobile



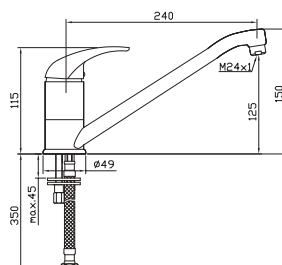

**Ref.: 65660**



Grifo mezclador para fregadero de repisa con caño giratorio inclinado

Sink mixer tap

Mitigeur évier

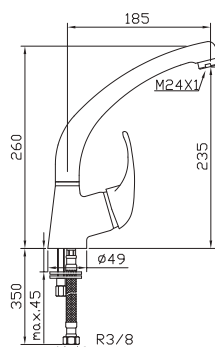

**Ref.: 65659/09**



Grifo mezclador para fregadero de repisa con caño fundido

Sink mixer with moulded spout

Mitigeur évier bec mobile haut fondu

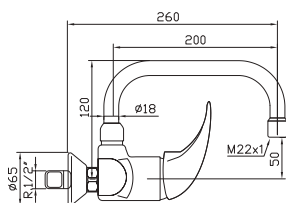

**Ref.: 65651/58**



Grifo mezclador mural con caño tubo

Mixer tap for wall sink

Mitigeur évier mural

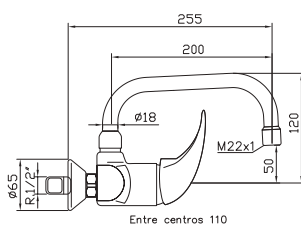

**Ref.: 65624/60**



Grifo mezclador para fregadero mural con caño de tubo 22 cm

Wall sink mixer. Spout 22 cm

Mitigeur évier mural. Bec 22 cm

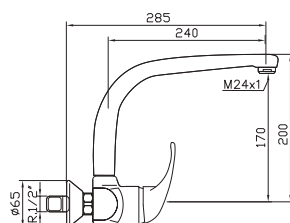

**Ref.: 65652/06**

Grifo mezclador para fregadero mural con caño fundido

Wall sink mixer with moulded spout

Mitigeur évier mural bec fondu

# Colección **LINK**

---

El agua es la fuerza motriz de toda la naturaleza.

Water is the driving force of all nature.

L'eau est la force motrice de toute la nature.

Leonardo da Vinci

---

---



**63 BOET PROFESSIONAL**

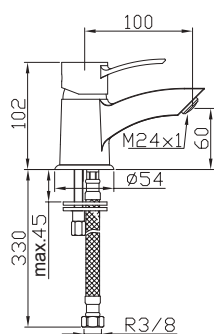

**Ref.: 63107**



**Ref.: 63108**



Grifo mezclador para lavabo

Basin mixer

Mitigeur lavabo

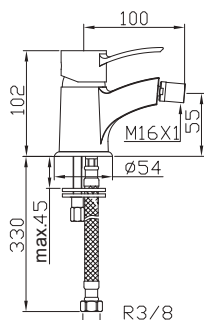

**Ref.: 63227**



**Ref.: 63228**



Grifo mezclador para bidé

Bidet mixer

Mitigeur bidet

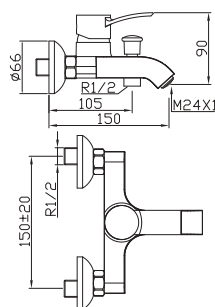

**Ref.: 63555**



**Ref.: 63555/0**



Mezclador exterior con inversor baño ducha

Exterior mixer tap with bath shower selector

Mitigeur bain douche avec inverseur

LINK

**BOET**

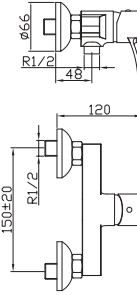

Ref.: 63424



Ref.: 63424/0



Mezclador exterior para ducha

Exterior mixer tap for shower

Mitigeur douche

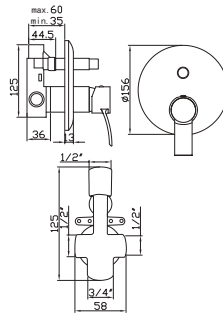

Ref.: 63556



Monomando baño ducha empotrado

Concealed bath-shower

Mitigeur bain douche à encastrer

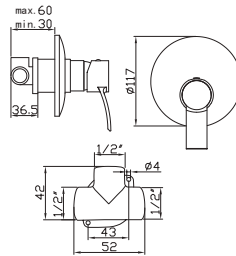

Ref.: 63425



Monomando ducha empotrado

Concealed shower

Mitigeur douche a encastrer

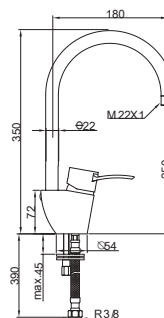

Ref.: 63657



Grifo mezclador para fregadero

Sink mixer

Mitigeur évier



# BOET COCINA





# BOET COCINA

# Colección **COCINA**

---

La creatividad es fácil, lo difícil es tener la idea.

Creativity is easy, the difficult thing is to have the idea.

La créativité est facile, la chose difficile est d'avoir l'idée.

Ferran Adrià

---



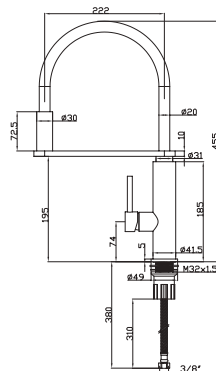

**Ref.: 82693 N**



Monomando fregadero caño  
silicona giratorio extensible

Sink mixer silicone spout  
rotating extendable

Mitigeur évier en silicone  
tournant extensible

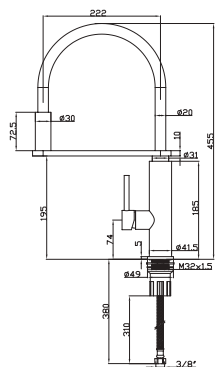

**Ref.: 82693 R**



Monomando fregadero caño  
silicona giratorio extensible

Sink mixer silicone spout  
rotating extendable

Mitigeur évier en silicone  
tournant extensible



Monomando fregadero caño  
silicona giratorio extensible

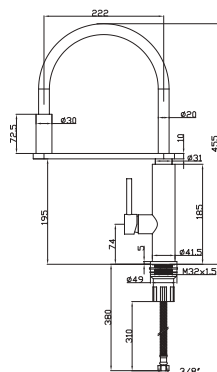

Sink mixer silicone spout  
rotating extendable

Ref.: 82693 B



Mitigeur évier en silicone  
tournant extensible



Monomando fregadero caño  
silicona giratorio extensible

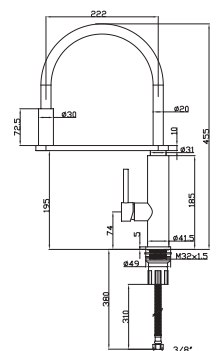

Sink mixer silicone spout  
rotating extendable

Ref.: 82693 A



Mitigeur évier en silicone  
tournant extensible

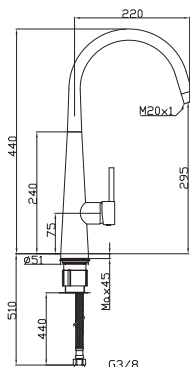

**Ref.: 82659**



Monomando fregadero repisa

Sink mixer shelf

Mitigeur d'évier

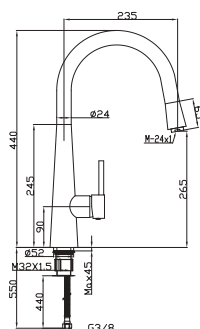

**Ref.: 82681**



Monomando fregadero repisa con ducha extraible

Sink mixer shelf with removable shower

Mitigeur d'évier avec douchette amovible

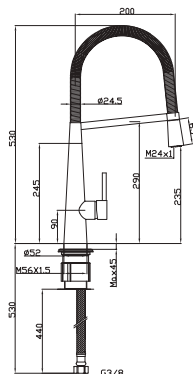

**Ref.: 82692**



Monomando fregadero repisa con muelle extensible

Single-lever sink mixer with extension spring

Mitigeur d'évier à levier unique avec ressort d'extension





**Ref.: 94658**

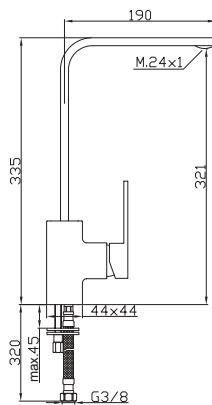

Grifo mezclador para fregadero

Sink Mixer

Mitigeur évier



**Ref.: 88659/09**

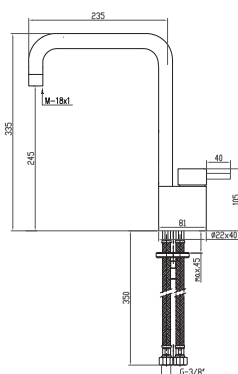

Grifo mezclador para fregadero de repisa con caño en tubo recto

Sink mixer with formed spout

Mitigeur évier bec mobile haut tube





Grifo mezclador para fregadero de repisa con caño de tubo

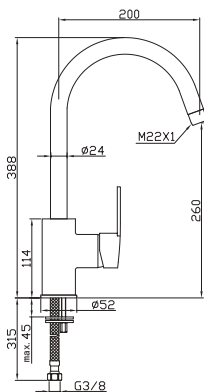

Sink mixer with formed spout

Ref.: 97657



Mitigeur évier bec mobile haut tube



Grifo mezclador para fregadero de repisa con caño de tubo

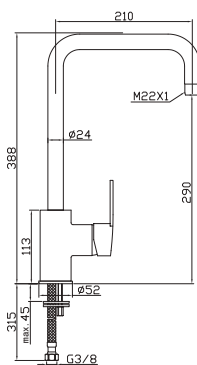

Sink mixer with formed spout

Ref.: 97658



Mitigeur évier bec mobile haut tube





**SENSOR  
IMPALA  
TEMPORIZADAS  
ESPECIALES**

**BOET COLECTIVIDADES**

**BOET**

Colección **SENSOR**

---

---

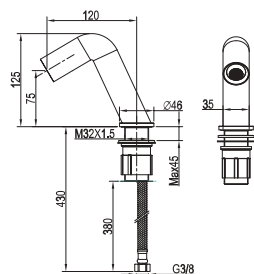

**51 BOET COLECTIVIDADES**

**Ref.: 51101**

Sensor 1 lavabo, agua fría  
o premezclada

Sensor 1 basin cold water mixer

Sensor 1 lavabo eau froid

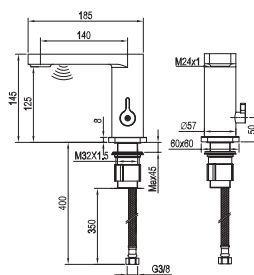
**Ref.: 51102**

Sensor 2 para lavabo con  
mezclador de temperatura

Sensor 2 mixeur

Sensor 2 mitigeur

Colección  
**IMPALA**



**15 BOET COLECTIVIDADES**

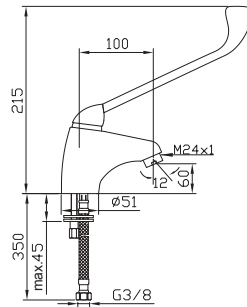

**Ref.: 15107**

Grifo mezclador para lavabo con palanca gerontológica

Mixer tap for washbasin with gerontological lever

Mitigeur pour vasque avec levier gérontologique

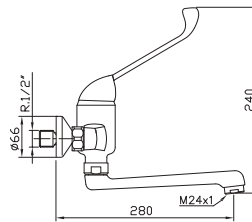

**Ref.: 15651/76**

Grifo mezclador para fregadero mural con caño bajo fundido, con palanca gerontológica

Mixer tap for wall-mounted sink with cast base spout and gerontological lever

Mélangeur pour évier mural avec bec coulé et levier gérontologique

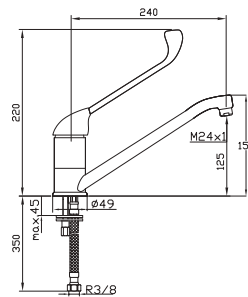

**Ref.: 15660**

Grifo mezclador para lavabo/ fregadero con caño giratorio inclinado y palanca gerontológica

Sink mixer with tiled rotating spoud

Mitigeur évie avec bec mobile incliné



Colección

**TEMPORIZADAS**

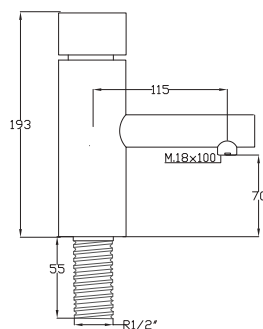

**89 BOET COLECTIVIDADES**

**Ref.: 89111**

Grifo temporizado lavabo INOX

Stainless steel bathroom tap

Robinet lavabo en acier inoxydable

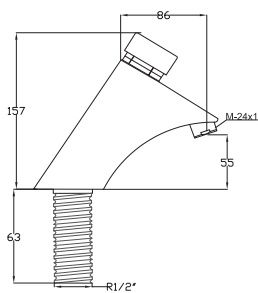
**Ref.: 89112**Grifo temporizado de lavabo  
en latón cromado

Chromed brass bathroom tap

Robinet lavabo en laiton chromé

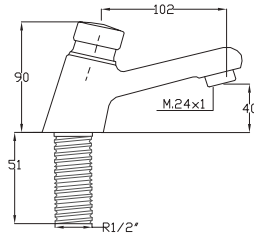

**Ref.: 89113**

Grifo temporizado de lavabo en latón cromado

Chromed brass bathroom tap

Robinet lavabo en laiton chromé

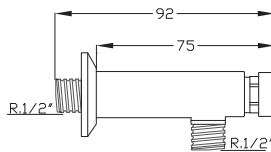

**Ref.: 89800**

Ducha  
Shower  
Ddouché

**Ref.: 89801**

Urinario  
Urinary  
Urinaire

Grifo ducha de 1/2"

Shower faucet of 1/2"

Robinet douche de 1/2"

Colección

**ESPECIALES**



**89 BOET COLECTIVIDADES**



Grifo mezclador de empotrar para bidé con duchita

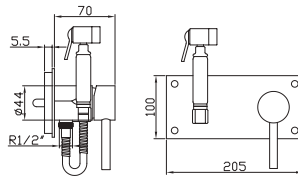

Concealed bidet mixer with shower

**Ref.: 82111**

Mitigeur bidet à encastrer avec douchette



Grifo mezclador para bidé con duchita

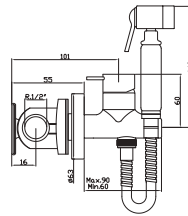

Concealed bidet mixer with shower

**Ref.: 82112**

Mitigeur bidet avec douchette



Duchita para wc

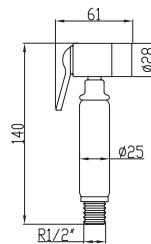

Shower for wc

**Ref.: 4035**

Douchette pour wc



Flexo

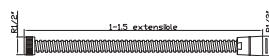

Hose

**Ref.: 4035/F**

Flexible



# BOET BARRA VISTA



# BOET BARRA VISTA







**Ref.:44431 N**

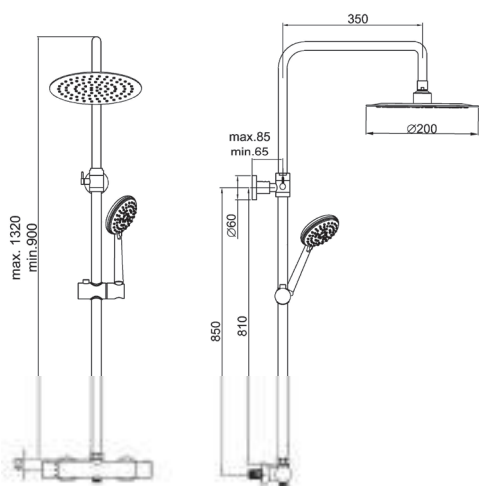
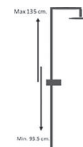

Shower mixer, with fixed view bar  
Equipped with sprinkler and  
Anti-lime shower hand le

Barra ducha vista  
Equipado con rociador y mango  
de ducha anti-cal

Mitigeur douche, avec colonne  
douche  
Équipé d'un asperseur et  
Poignée de douche anticalcaire

**BV BARRA VISTA TERMOSTÁTICAS TERMOSTYLE**



**Ref.:48430**

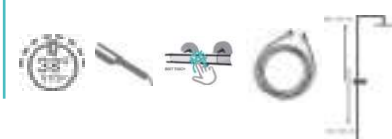

**TERMOSTYLE**

Barra ducha vista termostática. Inversor integrado. Mango 2 posiciones con pulsador, sistema "cool touch". Rociador anti cal de ABS

Thermostatic mixer, with sliding shower. Free touch. ABS anti-lime sprayer.

Mitigeur thermostatique pour douche avec colonne de douche, corp free touch. Pulvérisateur ABS anti-chaux

**Ref.:48530**

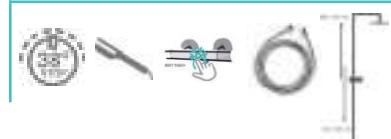

**TERMOSTYLE**

Barra vista termostática baño ducha. Inversor integrado. Mango 2 posiciones con pulsador, sistema "cool touch". Rociador anti cal de ABS

Bar view thermostatic bathroom shower. Free touch. ABS anti-lime sprayer.

Douche thermostatique salle de bain vue bar, corp free touch. Pulvérisateur ABS anti-chaux

# BARRA VISTA

## BV BARRA VISTA TERMOSTÁTICAS TERMOSOL



Ref.:44430

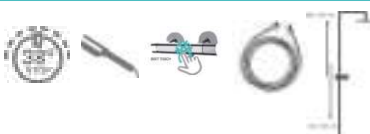

Ref.:44430/2

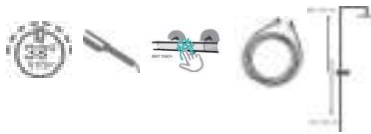

Ref.: 44430/3

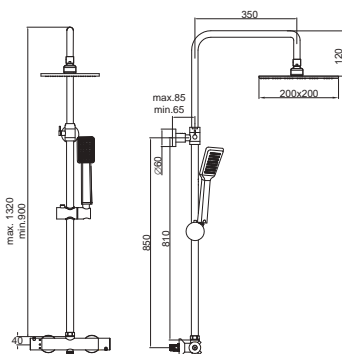
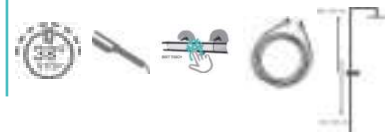

Barra ducha vista termostática.  
Inversor integrado. Mango 2  
posiciones con pulsador, sistema "cool  
touch". Rociador anti cal de ABS

Thermostatic mixer, with sliding  
shower. Free touch. ABS anti-lime  
sprayer.

Mitigeur thermostatique pour douche  
avec colonne de douche, corp free  
touch. Pulvérisateur ABS anti-chaux

### BV BARRA VISTA TERMOSTÁTICAS TERMOSTAR



Ref.: 35430/2



Ref.: 35430/C



Ref.: 35430/3

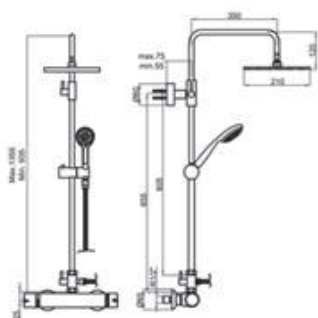

Barra de ducha vista termostática, TERMOSTAR, con tres opciones de rociador y maneral de ducha para su elección

Thermostatic view shower bar, TERMOSTAR, with three options of shower head and shower handle for your choice

Barre de douche thermostatique vue, TERMOSTAR, avec trois options de pomme de douche et poignée de douche pour votre choix

## BARRA VISTA

### BV BARRA VISTA MONOMANDO TUBULAR



Barra vista monomando selector de función integrado el grifo

Shower mixer tap with shower column function selector integrated in the tap

Mélangeur pour douche avec colonne sélecteur de fonction intégré dans en le robinet

**Ref.: 82430/3**



**Ref.: 82430/3/2**



## BARRA VISTA MONOMANDO JET



Ref.:96430/C



Ref.:96430/2



Ref.: 96430/3

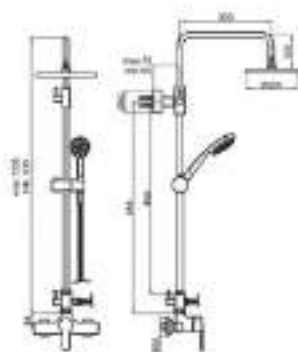

Mezclador monomando, telescópico para ducha JET. Mango ANTI-CAL de 3 posiciones. Rociador ANTI-CAL INOX de 3 mm

Shower mixer tap with shower column JET INOX shower sprayer 3 mm

Melangeur pour douche mural avec colonne de douche JET Asperseur INOX 3 mm

**BV MONOMANDO LUCA**



**Ref.: 14430**



Mezclador exterior para ducha LUCA, con barra vista fija

Shower mixer, with fixed view bar

Mitigeur de douche d'extérieur, avec colonne de douche

**BV MONOMANDO TRIANON MX**



**Ref.: 80430/C MX**



Mezclador monomando TRIANON MX para exterior para ducha, con barra vista telescópica

Shower mixer with sliding shower

Mitigeur pour douche avec colonne de douche



Barra de ducha vista telescópica para grifería baño ducha

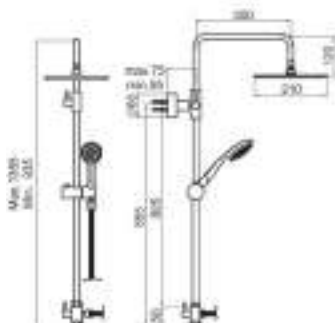

Shower rod telescopic view bathroom shower tap

Ref.: 4078/C



Tringle de douche vue télescopique salle de bain douche robinet



Barra de ducha vista telescópica para grifería baño ducha

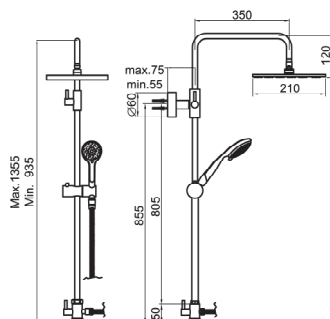

Shower rod telescopic view bathroom shower tap

Ref.: 4078/E



Tringle de douche vue télescopique salle de bain douche robinet



Enlace distribuidor para barra vista

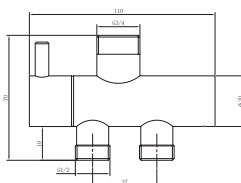

Connection distributor for shower column

Ref.: 4032 I

Conexion distributeur pour colonne de douche







# BOET BIMANDO



**TERRA  
CLASSIC  
ANTIQUE  
VERONA  
PISA**

**BOET BIMANDO**

Colección  
**TERRA**

La belleza se define como la manifestación sensible de la idea.

Beauty is defined as the sensible manifestation of the idea.

La beauté est définie comme la manifestation sensible de l'idée.

Friedrich Hegel



**74 BOET BIMANDO**



Grifo monobloque para lavabo.  
Montura cerámica 180°

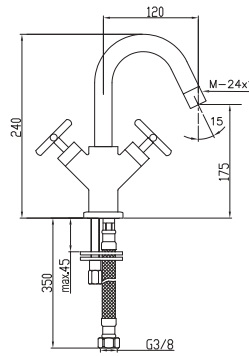

Basin mixer with swivelling spout

**Ref.: 74107**

**Ref.: 74108**



Mélangeur lavabo bec tube,  
avec tête céramique demi-tour



Grifo monobloque para bidé con  
rótula. Montura cerámica 180°

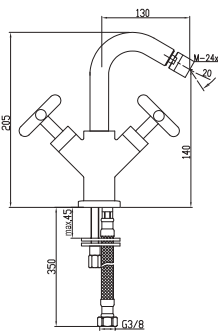

Bidet mixer with swivelling  
spout

**Ref.: 74227**

**Ref.: 74228**



Mélangeur bidet bec tube,  
avec tête céramique demi-tour

**Ref.: 74555**

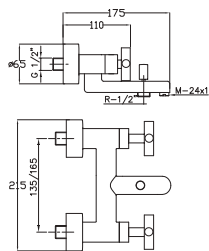

Mezclador exterior con inversor  
baño ducha, montura cerámica 180°

Bath-shower mixer

Mélangeur bain-douche avec tête  
ceramique demi-tour

**Ref.: 74424**

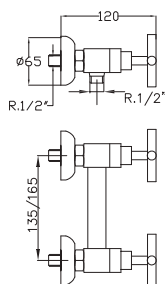

Mezclador exterior para ducha,  
montura cerámica 180°

Shower mixer

Mélangeur douche avec tête  
ceramique demi-tour

**Ref.: 74657/11**

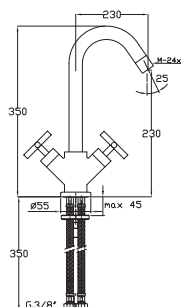

Grifo monobloque para fregadero  
con caño giratorio vertical.  
Montura cerámica 180°

Mono Sink mixer

Mélangeur por évier avec bec  
orientable, et tête céramique demi-  
tour

## Colección **CLASSIC**

Es difícil juzgar la belleza: la belleza es un enigma.

It is difficult to judge beauty: beauty is an enigma.

Il est difficile de juger la beauté: la beauté est une énigme.

Fiodor Dostoievski

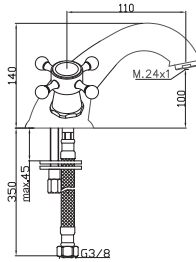

**75 BOET BIMANDO**

**Ref.: 75147**

Grifo monobloque para lavabo

Basin mixer

Mitigeur lavabo

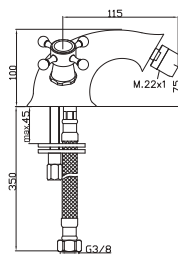
**Ref.: 75247**

Grifo monobloque para bidé

Bidet mixer

Mitigeur bidet



## CLASSIC

# BOET



Mezclador exterior con inversor baño-ducha

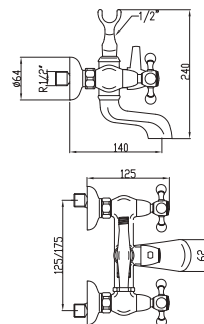

Exterior mixer tap with bath-shower selector

Ref.: 75556



Mitigeur bain douche avec inverseur



Mezclador exterior para ducha

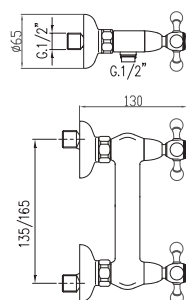

Exterior mixer tap for shower

Ref.: 75426



Mitigeur douche



Grifo monobloque para fregadero caño vertical

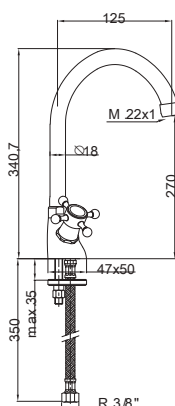

Mono sink mixer

Ref.: 75656

Mélangeur por évier avec bec orientable, et tété céramique demi-tour

Colección  
**ANTIQUÉ**

Los detalles no son sólo los detalles. Ellos hacen el diseño.

The details are not just the details. They do the design.

Les détails ne sont pas seulement les détails. Ils font le design.

Charles Earnes



**72 BOET BIMANDO**



Grifo monobloque para lavabo

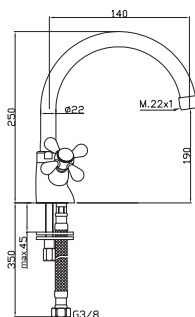

Basin Mixer

**Ref.: 72147**

**Ref.: 72148**



Mitigeur lavabo



Grifo monobloque para bidé

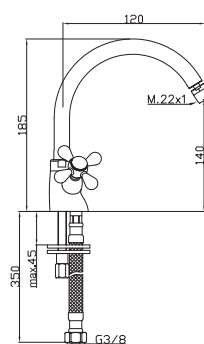

Bidet mixer

**Ref.: 72247**

**Ref.: 72248**



Mitigeur bidet

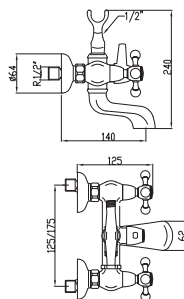

**Ref.: 72556**



Mezclador exterior con inversor baño-ducha

Exterior mixer tap with bath-shower selector

Mitigeur bain douche avec inverseur

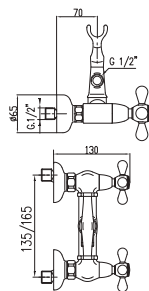

**Ref.: 72426**



Mezclador exterior para ducha

Exterior mixer tap for shower

Mitigeur douche

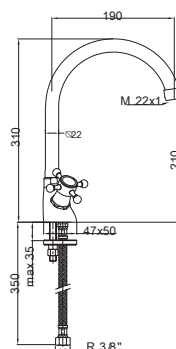

**Ref.: 72656**

Grifo monobloque para fregadero caño vertical

Mono sink mixer

Mélangeur por évier avec bec orientable, et tété céramique demi-tour

# Colección

## VERONA

El deseo de crear, es uno de los más profundos anhelos del alma humana.

The desire to create is one of the deepest longings of the human soul.

Le désir de créer est l'une des aspirations les plus profondes de l'âme humaine.

Dieter F. Uchtdorf

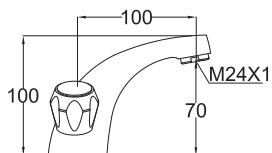

**73 BOET BIMANDO**

**Ref.: 73107****Ref.: 73108**

Grifo monobloque para lavabo

Mono basin mixer

Mélangeur lavabo

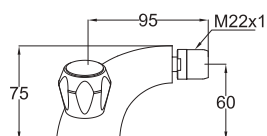
**Ref.: 73227****Ref.: 73228**Grifo monobloque para bidé  
con rótula

Mono bidet mixer

Mélangeur bidet

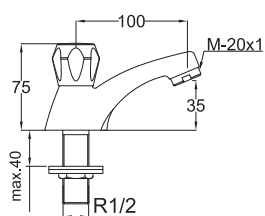
**Ref.: 73101**Grifo de repisa para lavabo  
con atomizador

Basin tap

Robinet simple pour lavabo

Ref.: 73201

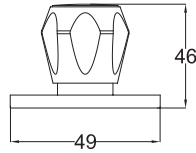

Grifo integral para bidé

2 Hole bidet mixer

Robinet pour bidet

Ref.: 73555

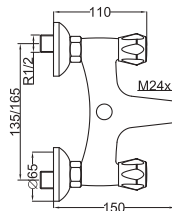

Ref.: 73555/0



Mezclador exterior con  
inversor baño ducha

Exterior mixer tap with bath  
shower selector

Mélangeur bain-douche avec  
inverseur

Ref.: 73424

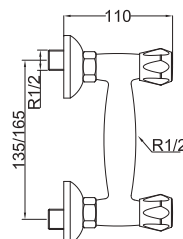

Ref.: 73424/0



Mezclador exterior para ducha

Exterior mixer tap for shower

Mélangeur douche

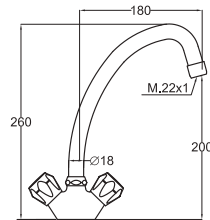

**Ref.: 73657/11**

Grifo monobloque para fregadero con caño vertical giratorio

Mono sink mixer

Mélangeur pour évier avec bec orientable

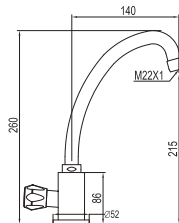

**Ref.: 73620/11**

Grifo fregadero caño vertical giratorio

Mono sink mixer

Mélangeur pour évier bec orientable

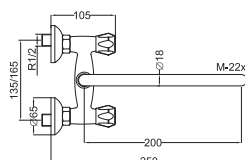

**Ref.: 73631/60**

Mezclador exterior fregadero mural, caño tubo horizontal superior de **20 mm**.

Wall sink mixer **20 mm**.

Mélangeur pour évier mural. **20 mm**.

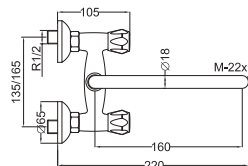

**Ref.: 73631/58**

Mezclador exterior fregadero mural, caño tubo horizontal superior de **16 mm**.

Wall sink mixer **16 mm**.

Mélangeur pour évier mural. **16 mm**.



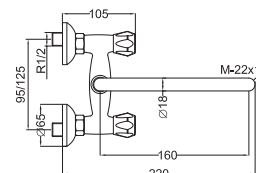
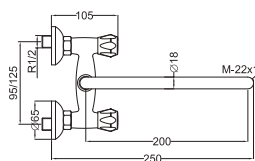

**Ref.: 73624/60**

Mezclador exterior fregadero mural, caño tubo horizontal superior de **20 mm**.

Wall sink mixer **20 mm**.

Mélangeur pour évier mural. **20 mm**.

**Ref.: 73624/58**

Mezclador exterior fregadero mural, caño tubo horizontal superior de **16 mm**.

Wall sink mixer **16 mm**.

Mélangeur pour évier mural. **16 mm**.

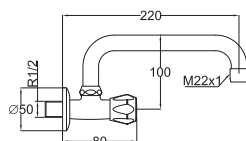

**Ref.: 73609/60**

Grifo giratorio para fregadero con caño superior

Wall mounted tap

Robinet bec mobile horizontal dessus

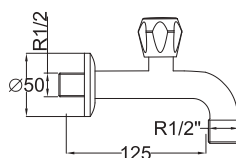

**Ref.: 73602**

Grifo de pared para fregadero

Wall mounted tap

Robinet mural

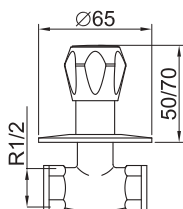
**Ref.: 73702**

Llave de paso para empotrar 1/2 "G

Remote control valve, 1/2"

Robinet d'arrêt 1/2 " encastré

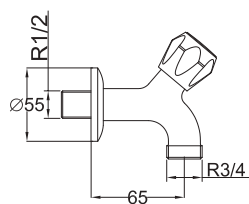
**Ref.: 73004**

Grifo de lavadora 1/2", salida 3/4"

Mixer for washing machine,  
1/2"-3/4"Robinet pour machine à laver  
1/2"-3/4"

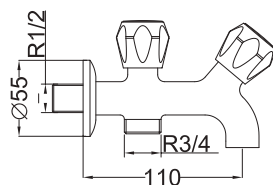

**Ref.: 73614**

Grifo para lavadora doble

Double mixer for washing machine

Robinet double pour machine à laver

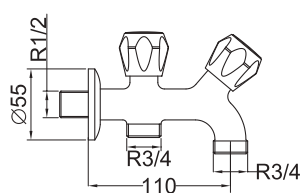

**Ref.: 73617**

Grifo para lavadora doble 3/4"

Double mixer for washing machine 3/4"

Robinet double pour machine à laver 3/4"

**BOET**

## Colección **PISA**

La creatividad es pensar más eficientemente.

Creativity is thinking more efficiently.

La créativité pense plus efficacement.

Pierre Reverdy



**78 BOET BIMANDO**

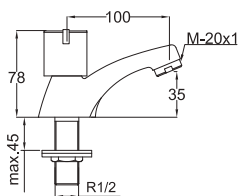

**Ref.: 78101**

Grifo de repisa para lavabo con aireador

Mono basin mixer

Mélangeur lavabo

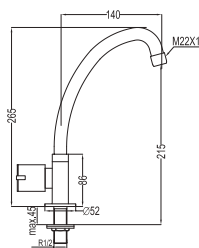

**Ref.: 78620/11**

Grifo fregadero caño vertical/ giratorio

Mono sink mixer

Mélangeur pour évier bec orientable

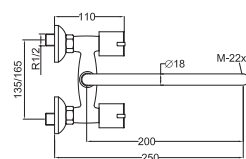

**Ref.: 78631/60**

Mezclador exterior fregadero mural caño tubo horizontal superior de **20 mm**.

Wall sink mixer **20 mm**.

Mélangeur pour évier mural. **20 mm**.

**Ref.: 78631/58**

Mezclador exterior fregadero mural caño tubo horizontal superior de **20 mm**.

Wall sink mixer **20 mm**.

Mélangeur pour évier mural. **20 mm**.

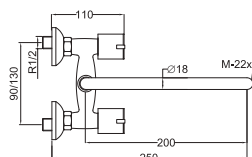

**Ref.: 78624/60**

Mezclador exterior de fregadero mural, caño tubo horizontal superior de **20 mm**.

Wall sink mixer **20 mm**.

Mélangeur pour évier mural. **20 mm**.

**Ref.: 78624/58**

Mezclador exterior de fregadero mural, caño tubo horizontal superior de **16 mm**.

Wall sink mixer **16 mm**.

Mélangeur pour évier mural. **16 mm**.

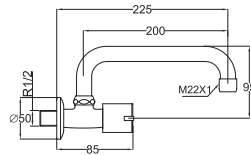

**Ref.: 78609/60**

Grifo giratorio para fregadero con caño superior

Wall mounted tap

Robinet bec mobile horizontal dessus

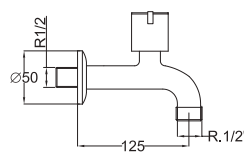

**Ref.: 78602**

Grifo fregadero pared con aireador

Wall mounted tap

Robinet mural



# TERMOSTATICAS





**EMPOTRADAS**

**EXTERIOR**

**BARRA VISTA**

EXTERIOR

EXTERIOR

**TERMOSTATICAS**

# TERMOSTATICA EMPOTRADAS

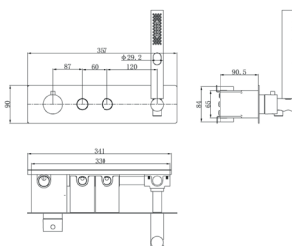

Ref.: 82148



Grifería termostática empotrada de ducha con soporte integrado en la placa con dos vías de salida

Built-in thermostatic shower mixer with support integrated in the plate with two exit ways

Mitigeur thermostatique de douche à encastrer avec support intégré dans la plaque avec deux sorties

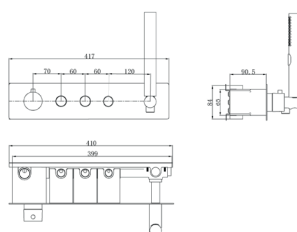

Ref.: 82149



Grifería termostática empotrada de ducha con soporte integrado en la placa con tres vías de salida

Built-in thermostatic shower mixer with support integrated in the plate with three exit ways

Mitigeur thermostatique de douche à encastrer avec support intégré dans la plaque avec trois sorties

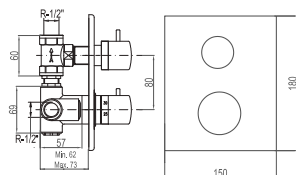

**Ref.: 82559**



Mezclador termostático para empotrar baño ducha 2 salidas

Bath / shower thermostatic mixer

Bain / douche thermostatique a encastre

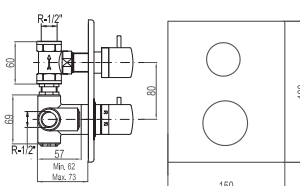

**Ref.: 82428**



Mezclador termostático para empotrar de ducha

Concealed thermostatic shower

Mitigeur Douche thermostatique

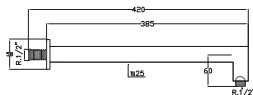
**ACCESORIOS PARA TERMAL EMPOTRADA****Ref.: 4014**

Brazo de ducha fijo PRISMA

Fixed shower arm PRISMA

Bras de douche fixe PRISMA

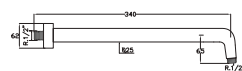
**Ref.: 4013**

Brazo de ducha fijo TUBULAR

Fixed shower arm TUBULAR

Bras de douche fixe TUBULAR

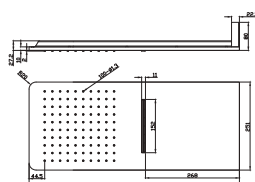
**Ref.: 4061**

Rociador con cascada slim inox

Slim stainless steel waterfall shower head

Pomme de douche cascade mince en acier inoxydable

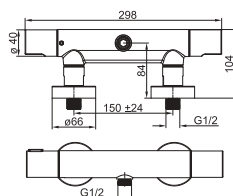

**TERMOSTATICA EXTERIOR TOUCH****Ref.: 44424**

Mezclador termostático exterior para ducha con sistema "cooltouch" para evitar quemaduras al tacto

Thermostatic shower mixer external system with "cooltouch"

Mitigeur de douche thermostatique d'extérieur avec système "cool touch" pour éviter les brûlures au toucher

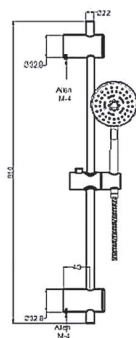
**Ref.: 4102**

Barra deslizante con ducha

Sliding bar with shower

Barre coulissante avec douche

TERMAL

**BOET**

# TERMOSTAR

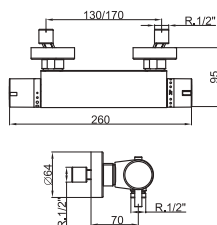

Ref.: 35424



Mezclador termostático exterior  
para ducha

Shower thermostatic mixer

Mitigeur thermostatique pour douche

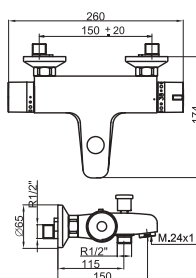

Ref.: 35555



Mezclador termostático exterior  
con inversor baño ducha

Bath-shower thermostatic mixer

Mitigeur thermostatique pour  
bain-douche









# BOET SHOWERS



# BOET SHOWERS



**Ref.: Shower Set1**

SHOWER SET1, 2 VIAS  
 Accesorios de ducha para empotrados, incluye brazo pared, rociador, Soporte c/toma, flexo y manual de ducha

SHOWER SET1, 2 WAYS  
 Complete recessed shower kit  
 Includes: wall arm, sprayer, Support w/outlet, hose and shower handle

SHOWER SET1, 2 FAÇONS  
 Kit de douche encastré complet  
 Comprend : bras mural, pulvérisateur, Support avec poignée de douche



**Ref.: Shower Set2**

SHOWER SET2, 2 VIAS  
 Accesorios de ducha para empotrados, incluye brazo pared, rociador, Soporte c/toma, flexo y manual de ducha

SHOWER SET1, 2 WAYS  
 Complete recessed shower kit  
 Includes: wall arm, sprayer, Support w/outlet, hose and shower handle

SHOWER SET1, 2 FAÇONS  
 Kit de douche encastré complet  
 Comprend : bras mural, pulvérisateur, Support avec poignée de douche



**Ref.: 4061**

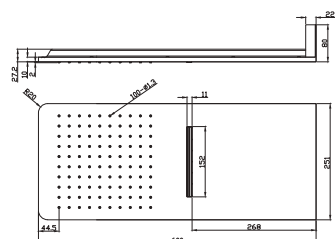

Rociador con cascada slim inox

Slim stainless steel waterfall shower head

Pomme de douche cascade mince en acier inoxydable



**Ref.: 4062**

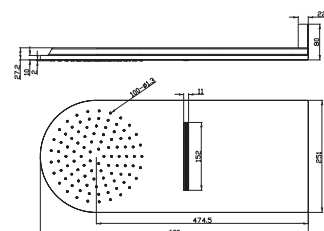

Rociador con cascada slim inox

Slim stainless steel waterfall shower head

Pomme de douche cascade mince en acier inoxydable

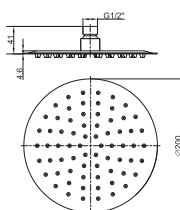

**Ref.: 4084**



20 Ø Slim inox

**Ref.: 4089**



30 Ø Slim inox

Rociador ducha INOX

INOX shower sprayer

Pulvérisateur de douche INOX

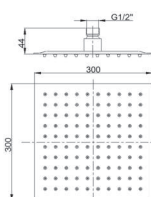

**Ref.: 4087**



**Ref.: 4095**

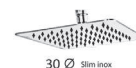

30 Ø Slim inox

Rociador ducha cuadrado INOX

INOX square shower head slim

Pulvérisateur de douche INOX carré

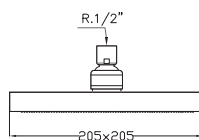

**Ref.: 4018**

Rociador PRISMA anticalcareo. Latón.

Shower sprayer PRISMA anti-calcareous. Brass.

Asperseur PRISMA anticalcaire. Laiton.

**Ref.: 4019**

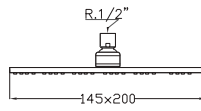

Rociador RECTANGULAR  
anticalcareo. Latón.

Shower sprayer RECTANGULAR  
anti-calcareous. Brass

Asperser RECTANGULAR  
anticalcaire. Laiton.

**Ref.: 4082**

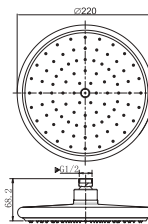

Rociador ABS TUBULAR  
anticalcáreo.

Shower sprayer ABS TUBULAR,  
anti-calcareous

Asperseur ABS TUBULAR,  
anticalcaire

**Ref.: 4016**

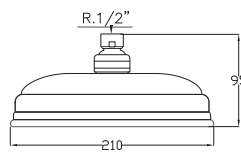

Rociador TERRA

Shower sprayer TERRA

Asperseur TERRA

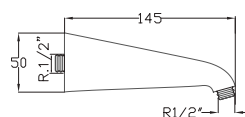
**Ref.: 4010**

Braço de ducha fijo 20 cm

Fixed shower arm 20 cm

Bras de douche fixe 20 cm

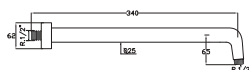
**Ref.: 4013**

Braço de ducha fijo TUBULAR

Fixed shower arm TUBULAR

Bras de douche fixe TUBULAR

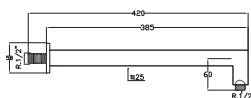
**Ref.: 4014**

Braço de ducha fijo PRISMA

Fixed shower arm PRISMA

Bras de douche fixe PRISMA



Ref.: 4096



Brazo de techo de 20 cm

Fixer shower roof 20 cm

Bras de plafond de 20 cm.

Ref.: 4086

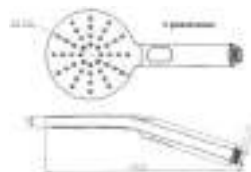

Mango de ducha 4 posiciones con pulsador, cromado

4 positions shower handle with push button, chromed

Poignée de douche 4 positions avec bouton poussoir, chromé

Ref.: 4083



Mango ducha anticalcáreo 5 posiciones

5 positions anti-limescale shower handle

Poignée de douche anti-calcaire à 5 positions

**Ref.: 4067**

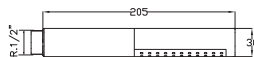

Mango ducha anticalcáreo TUBULAR

Anti-calcareous shower head TUBULAR

Douchette anticalcaire TUBULAR

**Ref.: 4057**

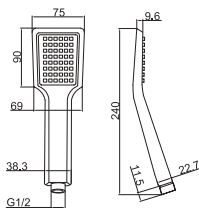

Mango ducha anticalcáreo PRISMA

Anti-calcareous shower head PRISMA

Douchette anticalcaire PRISMA

**Ref.: 4020**

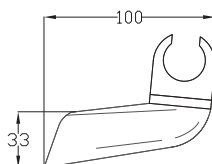

Soporte 2 posiciones rótula orientable

2 positions bracket with ajustable ball joint

Suport 2 positions, rotule orientable

**Ref.: 4026**

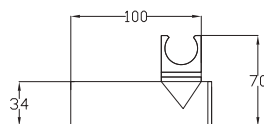

Soporte ducha orientable

Wall bracket

Support douche orientable

**Ref.: 4041**

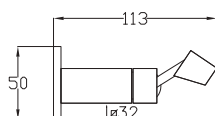

Soporte ducha rótula

Wall bracket

Support douche

**Ref.: 4033**

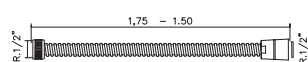

**Ref.: 4030**

Reforzado, doble engatillado  
Reinforced, double seam  
Reforcé, double couture

Flexo de ducha de latón, 175 cm

Brass shower hose 175 cm

Tuyau flexible chromé, long 175 cm



Flexo inox extensible  
180/200 cm, en bolsa



Flexo stainless extensible  
180/200 cm, in bags

**Ref.: 4053**

**Ref.: 4053/B**

Blister

Extensible inoxydable flexo  
180/200 cm, dans des sacs



Kit de ducha con mango de 3  
posiciones, flexo extensible,  
soporte orientable en blister

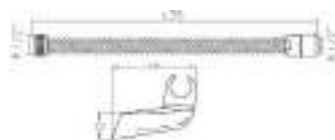

Shower kit with 3-position handle,  
extendable flexo, adjustable  
stand in blister

**Ref.: 4048**

Kit de douche avec poignée à 3  
positions, flexo extensible, support  
réglable en blister



Barra ducha deslizante

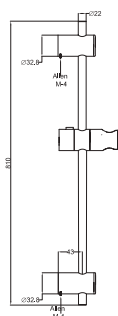

Sliding shower rod

**Ref.: 4100**



Barra deslizante con ducha



Sliding bar with shower

**Ref.: 4102**



Barra ducha deslizante



Sliding shower rod

**Ref.: 4040**



Kit de ducha LUNA c/ mango  
3 posiciones orientable

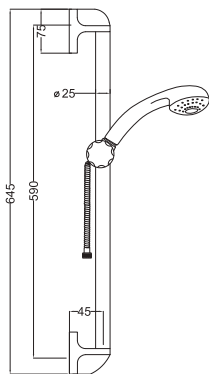

LUNA shower kit w / adjustable  
3 position handle

**Ref.: 4050**



Kit de douche LUNA avec douchette



Barra de ducha deslizante PRISMA

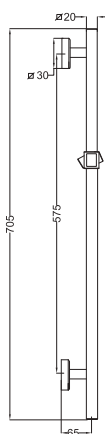

Slidding shower rood PRISMA

**Ref.: 4044**



Barre de douche coulissante  
PRISMA

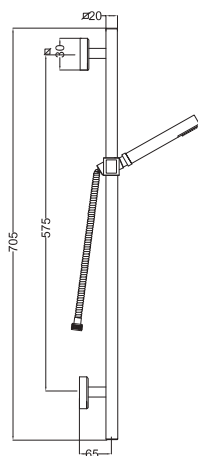

**Ref.: 4045**



Kit de ducha PRISMA c/ mango de ducha

PRISMA shower kit w / shower handle

Kit de douche PRISMA avec poignée de douche



# BOET SHOWROOM





**FOAMS**  
**PEANAS**  
**PANELES**  
**EXPOSITORES**

**BOET SHOWROOM**

# PEANAS



Peanas expositoras para sobreponer en lavabos o en estantes  
Display stands to be mounted on sinks or on shelves  
Présentoirs à monter sur évier ou sur étagères

Consulte con su agente o en [info@feliuboet.com](mailto:info@feliuboet.com)  
Consult with your agent or at [info@feliuboet.com](mailto:info@feliuboet.com)  
Consultez votre agent ou à [info@feliuboet.com](mailto:info@feliuboet.com)

# PANELES

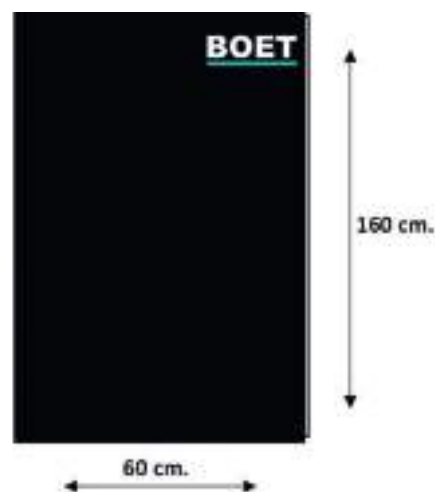

Panel expositor de pared para barras vistas BOET.

Wall display panel for BOET exposed bars.

Panneau d'affichage mural pour barres apparentes BOET.

Consulte con su agente o en [info@feliuboet.com](mailto:info@feliuboet.com)

Consult with your agent or at [info@feliuboet.com](mailto:info@feliuboet.com)

Consultez votre agent ou à [info@feliuboet.com](mailto:info@feliuboet.com)

# EXPOSITORES

## SOBREMESA



Consulte con su agente o en [info@feliuboet.com](mailto:info@feliuboet.com)  
Consult with your agent or at [info@feliuboet.com](mailto:info@feliuboet.com)  
Consultez votre agent ou à [info@feliuboet.com](mailto:info@feliuboet.com)

# EXPOSITORES

## EXPOSITOR DE PIE



Consulte con su agente o en [info@feliuboet.com](mailto:info@feliuboet.com)  
Consult with your agent or at [info@feliuboet.com](mailto:info@feliuboet.com)  
Consultez votre agent ou à [info@feliuboet.com](mailto:info@feliuboet.com)

# // Portfolio Public Projects

La diversidad de producto y soluciones de BOET, están instaladas en diferentes países y tipos de uso, de los que les mostramos algunos...

The diversity of product and BOET's solutions, they are installed in different countries and types of use. Of which we show them some ...

La diversité des produits et des solutions BOET, ils sont installés dans différents pays et types d'usage dont on leur montre quelques ...



Hotel Barcelo Raval, [Barcelona](#)







Hotel Axel, [Barcelona](#)



Hotel Tiara Miramar Beach, [France](#)



Hotel Acta Madfor, [Madrid](#)



Hotel Benalmadena Playa, [Málaga](#)



Hotel Bronze Playa, [Las Palmas](#)





Gran Hotel Bahia Duque, [Tenerife](#)



Luxury Apart. Marrakech, [Morocco](#)



Hotel Negresco, [Francia](#)



Hotel Melia Cohiba, [Cuba](#)



Hotel Copacabana, [Cuba](#)







Hotel Yangzhou, [China](#)



Hotel Jingwei, [China](#)



Hotel Melia Las Antillas, [Cuba](#)



CN Sant Andreu, [Barcelona](#)



Hospital Virgen de la Macarena, [Sevilla](#)



TNC Teatro Nacional, [Barcelona](#)

## Boet contact guide



comercial@feliuboet.com



admon@feliuboet.com



calidad@feliuboet.com



export@feliuboet.com

## Boet address



**FELIU BOET GRIFERIAS S.L.**

AV. DE CATALUNYA, 15-17  
08758 CERVELLÓ  
BARCELONA - SPAIN



0034 93 684 05 04



0034 93 684 05 16



feliuboet@feliuboet.com

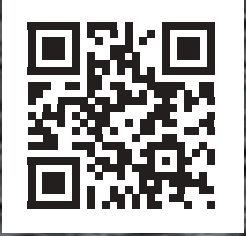

[www.feliuboet.com](http://www.feliuboet.com)