



CATALOGO 20 **23**



CL. Virgen de los Desamparados, Nave 8
DOS HERMANAS (SEVILLA)
TELEF: 955292296 - 649988049
pedidos@eggriferia.es - www.eggriferia.es



eq
GRIFERIA®





5 AÑOS DE GARANTIA
EN TODOS NUESTROS
ACABADOS
NO ESPECIALES



Tecnología,
Calidad
y Seguridad
en toda nuestra
gama de productos.

INDICE



SERIE 411
Pag. 8



SERIE 171
Pag. 10



SERIE NIZA
Pag. 12



SERIE NIZA Negro
Pag. 14



SERIE AURA
Pag. 16



SERIE AURA Negro
Pag. 18



SERIE GOLDEN
Pag. 20



SERIE GOLDEN Bronce
Pag. 22



Termostáticas
Pag. 24





Medical, Temporizada
Pag. 26



KITS de Ducha
Pag. 28



SERIE COCINAS
Pag. 32



FREGADEROS
Pag. 40



ACCESORIOS
Pag. 44



SERIE
411



Ref: 41101

Monomando de Lavabo

Cartucho de 40 mm
Apertura Suave
Con conexiones flexibles
12 Unidades caja completa

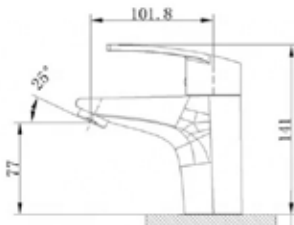

Ref: 41103

Monomando de Bidet

Cartucho de 40 mm
Apertura Suave
Con conexiones flexibles
12 Unidades caja completa

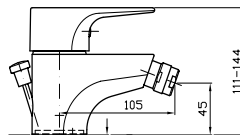

Ref: 41104

Monomando de Baño

Cartucho de 40 mm
Apertura Suave
Con conexiones flexibles
6 Unidades caja completa



Ref: 41102

Monomando de Ducha

Cartucho de 40 mm
Apertura Suave
Con conexiones flexibles
6 Unidades caja completa

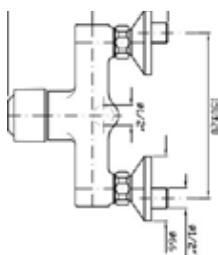

Ref: 412502

Kit Ducha 411
Barra extensible de altura regulable 90 - 140 cm
Duchón 20cm Inox

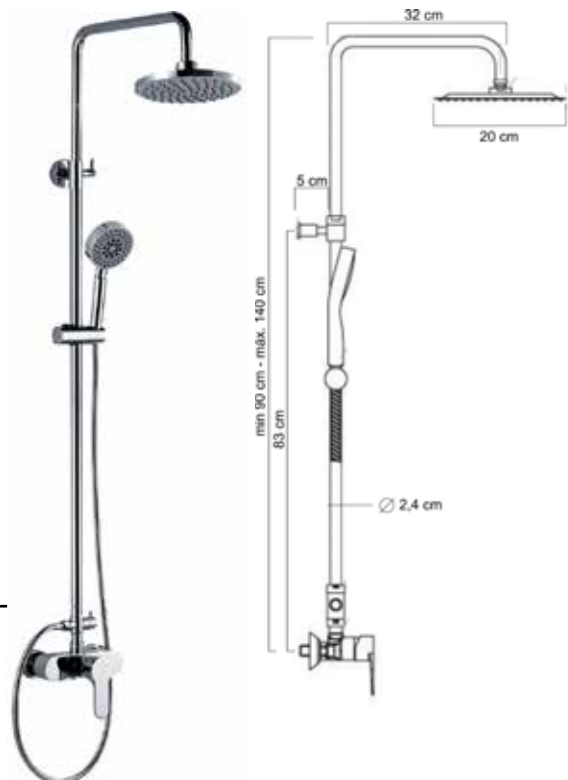



SERIE
171



SERIE
Niza



Ref: 982205

Monomando de Lavabo Alto
 Cartucho de 35 mm
 Apertura Suave
 Con conexiones flexibles
 12 Unidades caja completa

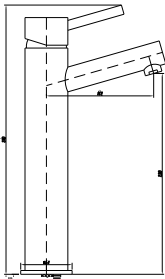

Ref: 982201

Monomando de Lavabo Bajo
 Cartucho de 35 mm
 Apertura Suave
 Con conexiones flexibles
 12 Unidades caja completa

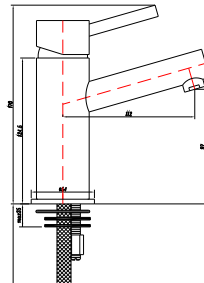

Ref: 982203

Monomando de Bidet
 Cartucho de 35 mm
 Apertura Suave
 Con conexiones flexibles
 12 Unidades caja completa

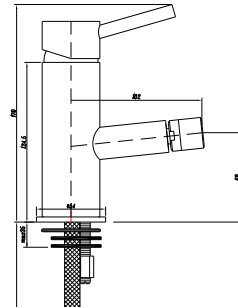

Ref: 982204

Monomando de Baño
 Cartucho de 35 mm
 Apertura Suave
 Flexo Ducha Soporte
 6 Unidades caja completa

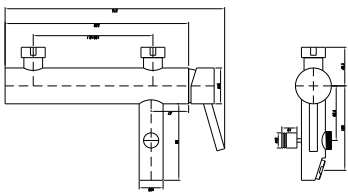

Ref: 982202

Monomando de Ducha
 Cartucho de 35 mm
 Apertura Suave
 Flexo Ducha Soporte
 6 Unidades caja completa

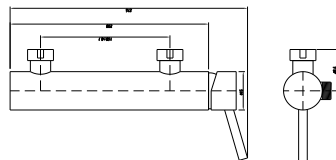

Ref: 982502

Kit Ducha 171
 Barra extensible de altura regulable 90 - 140 cm
 Duchón 20cm Inox

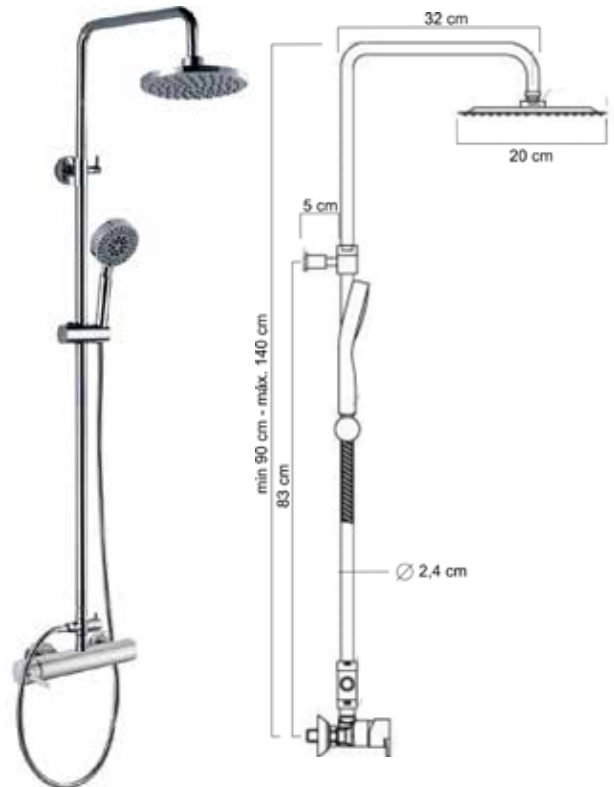



SERIE
Niza Negro



Ref: 982205N

Monomando de Lavabo Alto
 Cartucho de 35 mm
 Apertura Suave
 Con conexiones flexibles
 12 Unidades caja completa

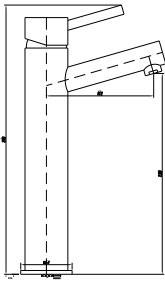

Ref: 982201N

Monomando de Lavabo Bajo
 Cartucho de 35 mm
 Apertura Suave
 Con conexiones flexibles
 12 Unidades caja completa

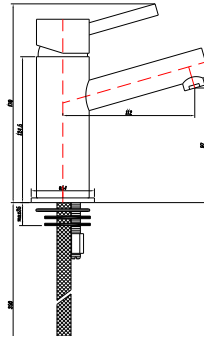

Ref: 982203N

Monomando de Bidet
 Cartucho de 35 mm
 Apertura Suave
 Con conexiones flexibles
 12 Unidades caja completa

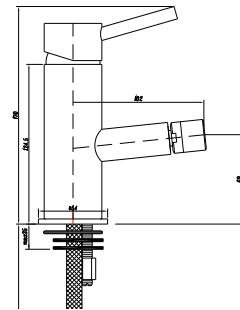

Ref: 982204N

Monomando de Baño
 Cartucho de 35 mm
 Apertura Suave
 Flexo Ducha Soporte
 6 Unidades caja completa

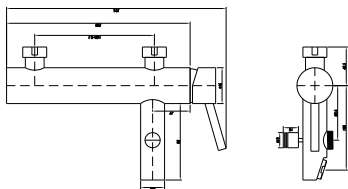

Ref: 982202N

Monomando de Ducha
 Cartucho de 35 mm
 Apertura Suave
 Flexo Ducha Soporte
 6 Unidades caja completa

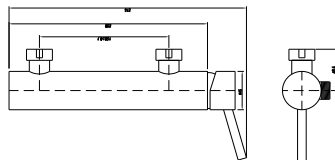

Ref: 982502N

Kit Ducha 171
 Barra extensible de altura regulable 90 - 140 cm
 Duchón 20cm Inox

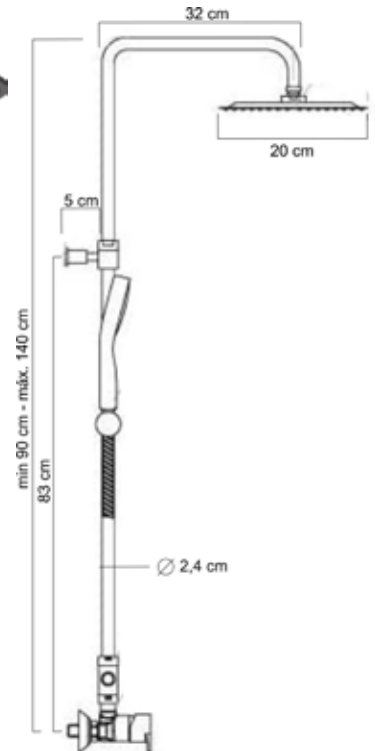



SERIE
Aura



Ref: 932205

Monomando de Lavabo Alto
 Cartucho de 25 mm
 Apertura Suave
 Con conexiones flexibles
 12 Unidades caja completa

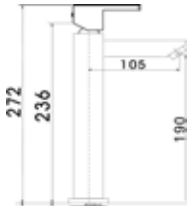

Ref: 932201

Monomando de Lavabo Bajo
 Cartucho de 25 mm
 Apertura Suave
 Con conexiones flexibles
 12 Unidades caja completa



Ref: 932203

Monomando de Bidet
 Cartucho de 25 mm
 Apertura Suave
 Con conexiones flexibles
 12 Unidades caja completa

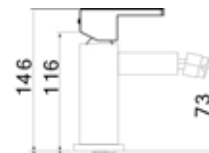

Ref: 932204

Monomando de Baño
 Cartucho de 35 mm
 Apertura Suave
 Flexo Ducha Soporte
 6 Unidades caja completa

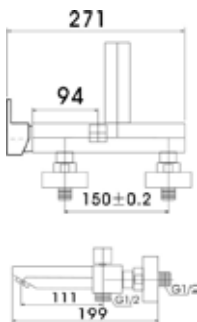

Ref: 932202

Monomando de Ducha
 Cartucho de 35 mm
 Apertura Suave
 Flexo Ducha Soporte
 6 Unidades caja completa

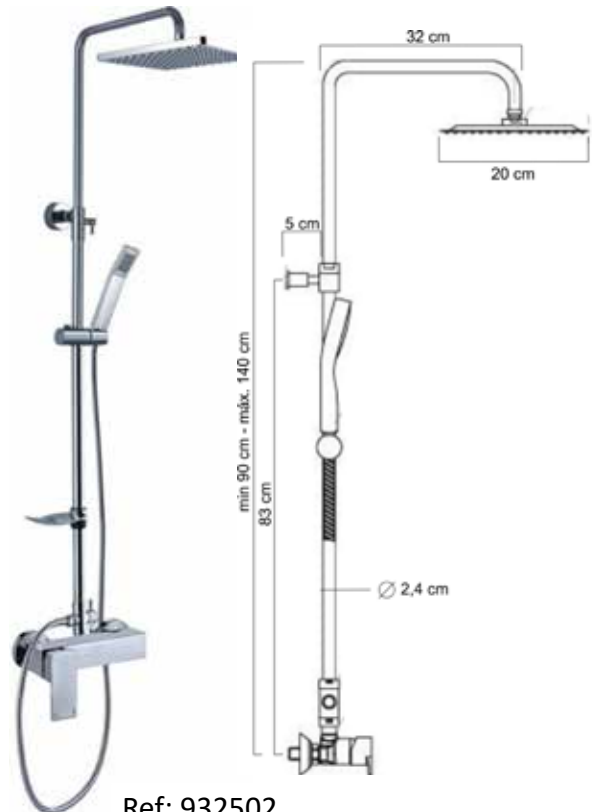
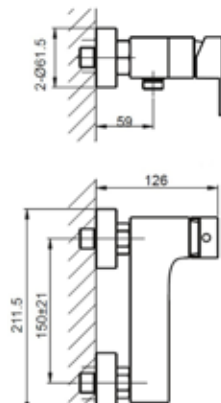

Ref: 932502

Kit Ducha 171
 Barra extensible de altura regulable 77 - 122 cm
 Duchón 20cm Inox



SERIE
Aura Negro



Ref: 932205N

Monomando de Lavabo Alto
 Cartucho de 25 mm
 Apertura Suave
 Con conexiones flexibles
 12 Unidades caja completa

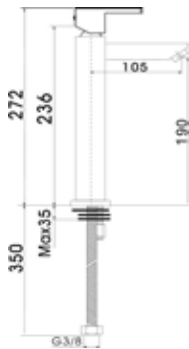

Ref: 932201N

Monomando de Lavabo Bajo
 Cartucho de 25 mm
 Apertura Suave
 Con conexiones flexibles
 12 Unidades caja completa

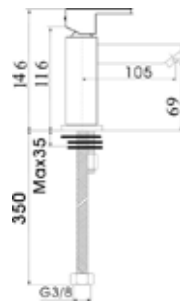

Ref: 932203N

Monomando de Bidet
 Cartucho de 25 mm
 Apertura Suave
 Con conexiones flexibles
 12 Unidades caja completa

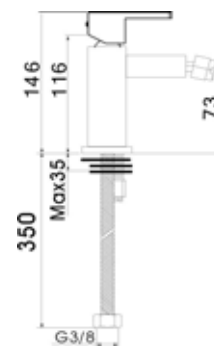

Ref: 932204N

Monomando de Baño
 Cartucho de 35 mm
 Apertura Suave
 Flexo Ducha Soporte
 6 Unidades caja completa

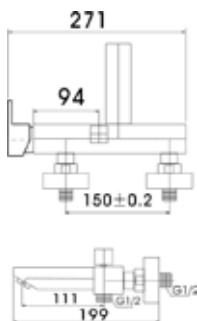

Ref: 932202N

Monomando de Ducha
 Cartucho de 35 mm
 Apertura Suave
 Flexo Ducha Soporte
 6 Unidades caja completa

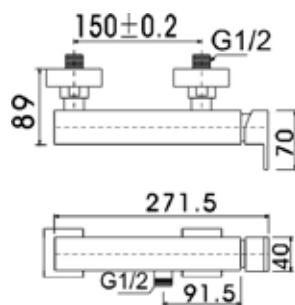



SERIE
Golden



Ref: 892301

Monoblock de Lavabo
 Montura cerámica
 Apertura media vuelta
 Con conexiones flexibles
 6 Unidades caja completa

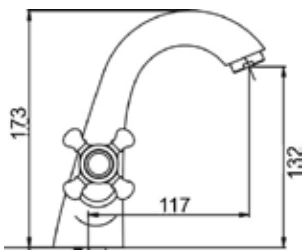

Ref: 892304

Monoblock de Baño
 Montura cerámica
 Flexo Ducha Soporte
 6 Unidades caja completa

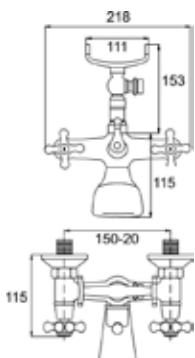

Ref: 892203

Monoblock de Bidet
 Montura cerámica
 Con conexiones flexibles
 6 Unidades caja completa

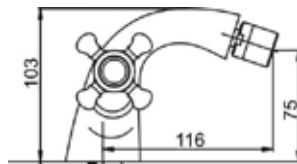

Ref: 892502

Kit Ducha Golden
 Barra extensible de altura regulable 77 - 122 cm
 Duchón 20cm Inox



Ref: 892302

Monoblock de Ducha
 Montura cerámica
 Flexo Ducha Soporte
 12 Unidades caja completa

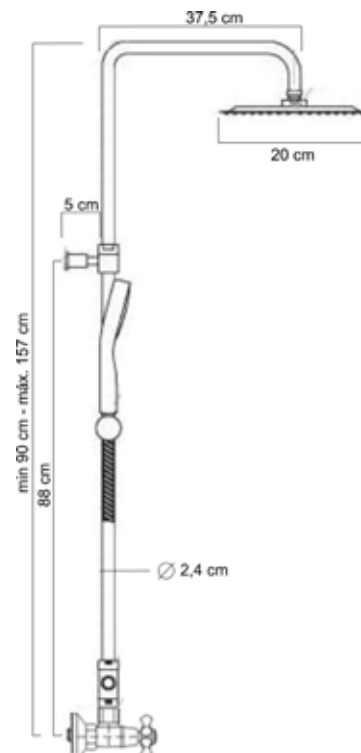
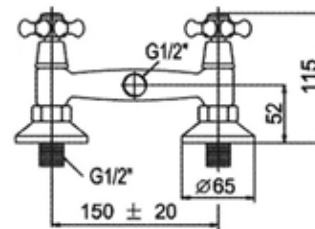



SERIE
Golden

Bronce



Ref: 892301BR

Monoblock de Lavabo
 Montura cerámica
 Apertura media vuelta
 Con conexiones flexibles
 6 Unidades caja completa

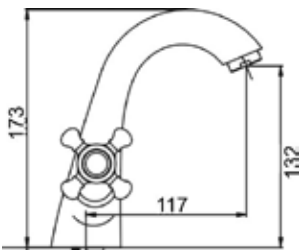

Ref: 892203BR

Monoblock de Bidet
 Montura cerámica
 Con conexiones flexibles
 6 Unidades caja completa

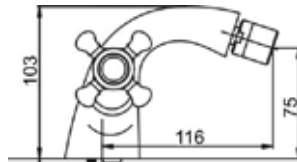

Ref: 892302BR

Monoblock de Ducha
 Montura cerámica
 Flexo Ducha Soporte
 12 Unidades caja completa

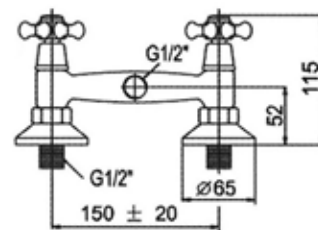

Ref: 892304BR

Monoblock de Baño
 Montura cerámica
 Flexo Ducha Soporte
 6 Unidades caja completa

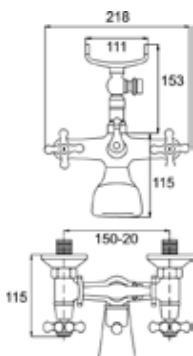

Ref: 892502BR

Kit Ducha Golden
 Barra extensible de altura regulable 77 - 122 cm
 Duchón 20cm ABS

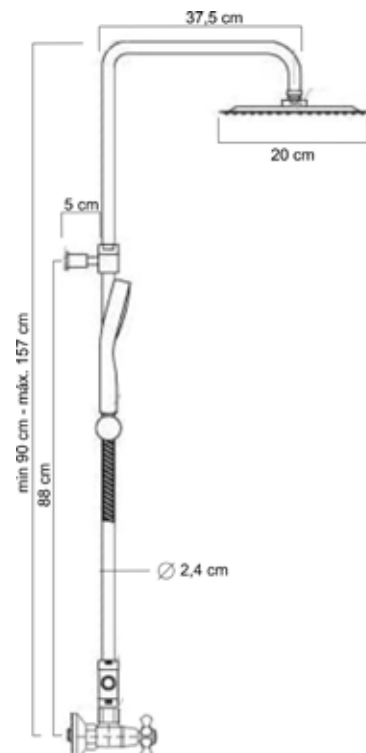

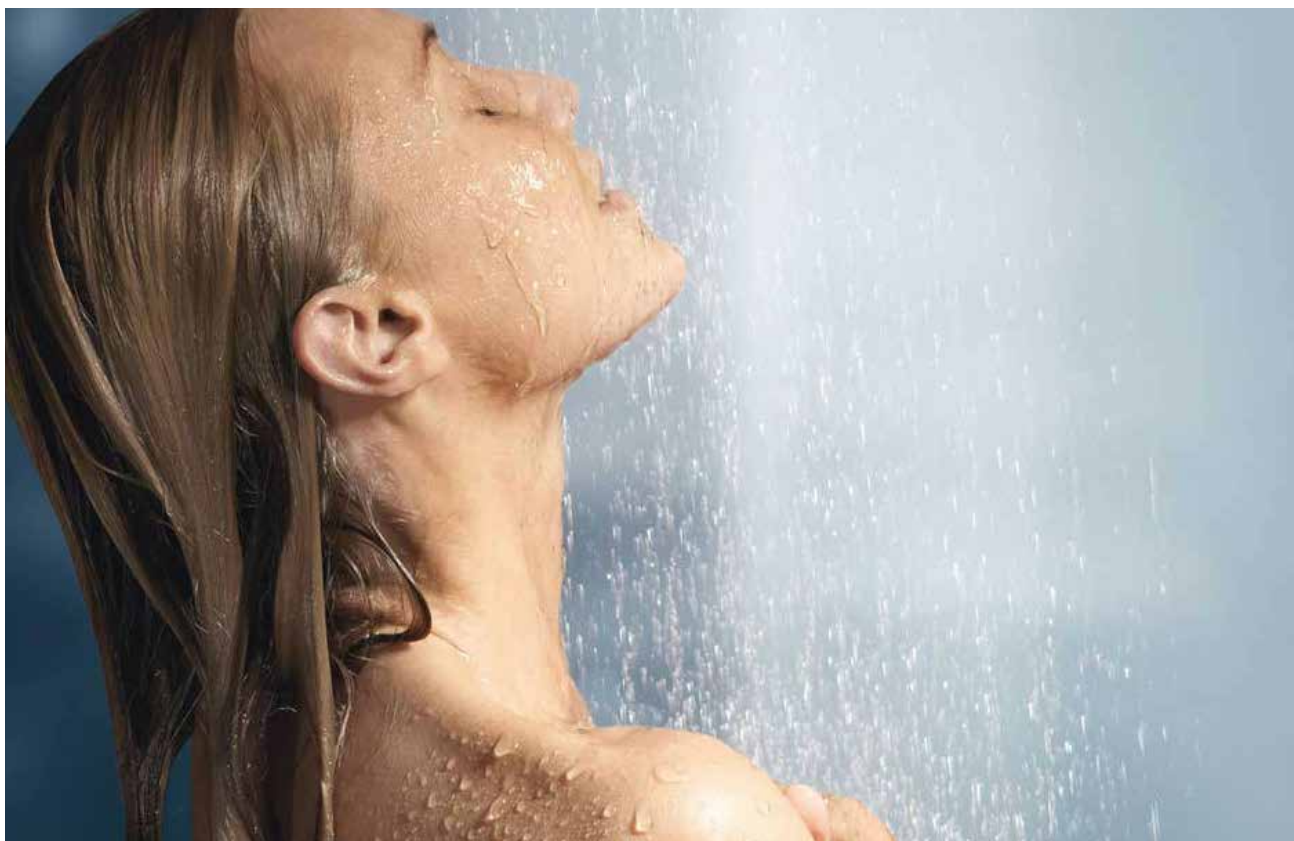

SERIE
Termostática



Ref: 242402

Ducha Termostática VEGA
6 Unidades caja completa

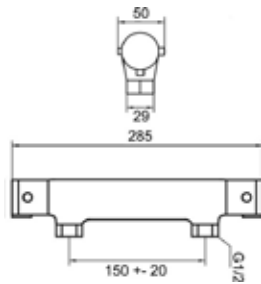

Ref: 342402

Ducha Termostático BASS
Cold Touch
6 Unidades caja completa

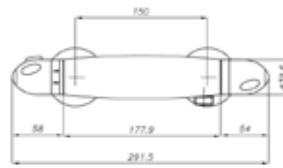

Ref: 242502

Kit Ducha VEGA
TERMOSTÁTICO
Barra extensible de altura
regulable 77 - 122 cm
Duchón 20cm Latón

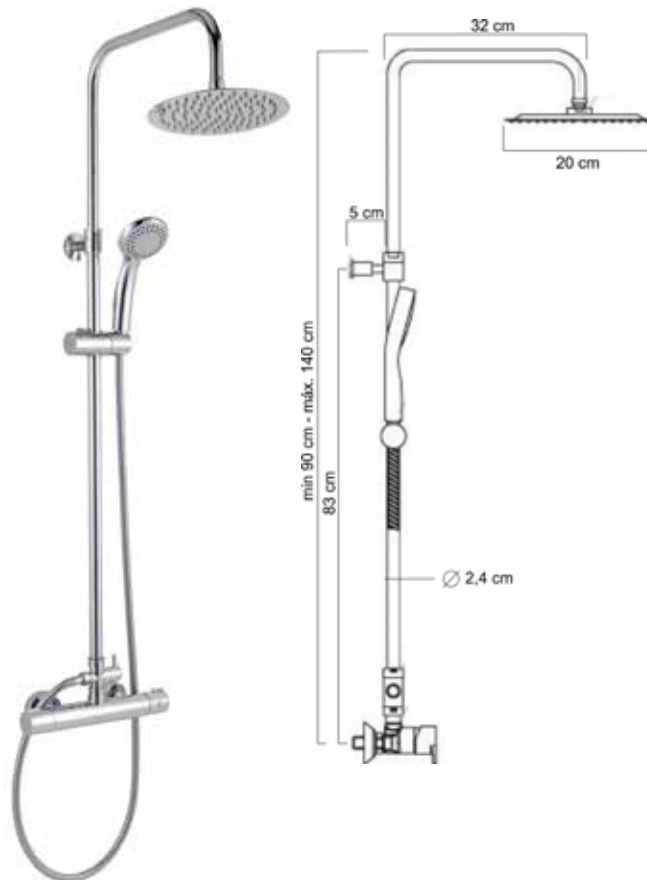

Grifería Medical



Ref: 771001

Monomando de Lavabo MEDICAL

Cartucho de 40 mm
Apertura Suave
Con conexiones flexibles
12 Unidades caja completa

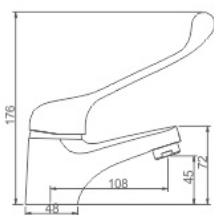

Ref: 601035

Monomando Fregadero MEDICAL

Cartucho de 40 mm
Apertura Suave
Con conexiones flexibles
12 Unidades caja completa

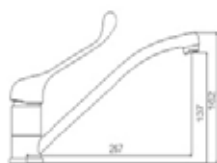

Ref: 601034

Monomando Freg. Pared MEDICAL

Cartucho de 40 mm
Apertura Suave
Flexo Ducha Soporte
12 Unidades caja completa

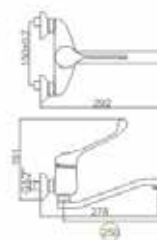

Grifería Temporizada



Ref: T110

Lavabo Temporizado

Un agua
30 unidades caja



Ref: T220

Urinario temporizado

Completo
30 unidades caja



Ref: 380

Ducha empotrar

Un agua
24 Unidades caja completa

Grifos de Bidet / WC



Ref: T403

Grifo Bidet / WC - Cromo
 Mezclador 2 aguas
 20 Unidades caja completa

Grifería de Pedal



Ref: T310

Grifo de pedal
 Un agua
 10 Unidades caja completa



Ref: T311

Grifo de pedal
 Mezclador de 2 aguas
 10 Unidades caja completa



Ref: T313

Grifo de 2 pedales
 Dos aguas
 10 Unidades caja completa



Ref: T320

Caño para Grifo de pedal
 Giratorio 360°



KITS de Ducha

EMPOTRADOS

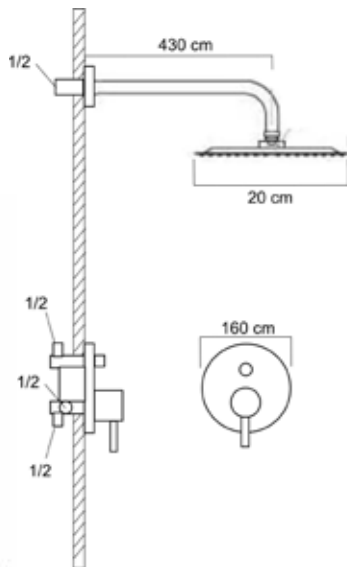

Ref: 983102N

Kit NIZA Negro
Empotrar

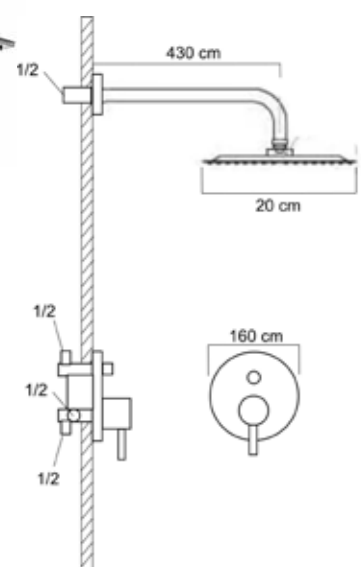

Ref: 933102

Kit AURA
Empotrar

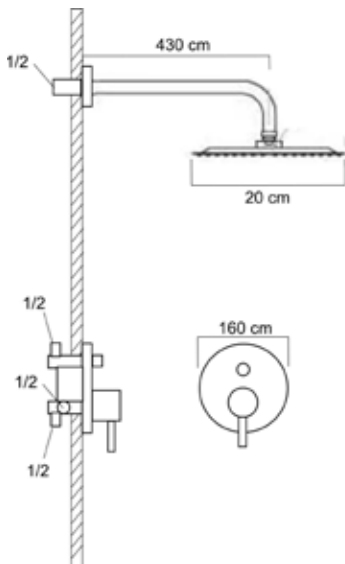

Ref: 753102

Kit SUPRA
Empotrar



Configuración personalizada

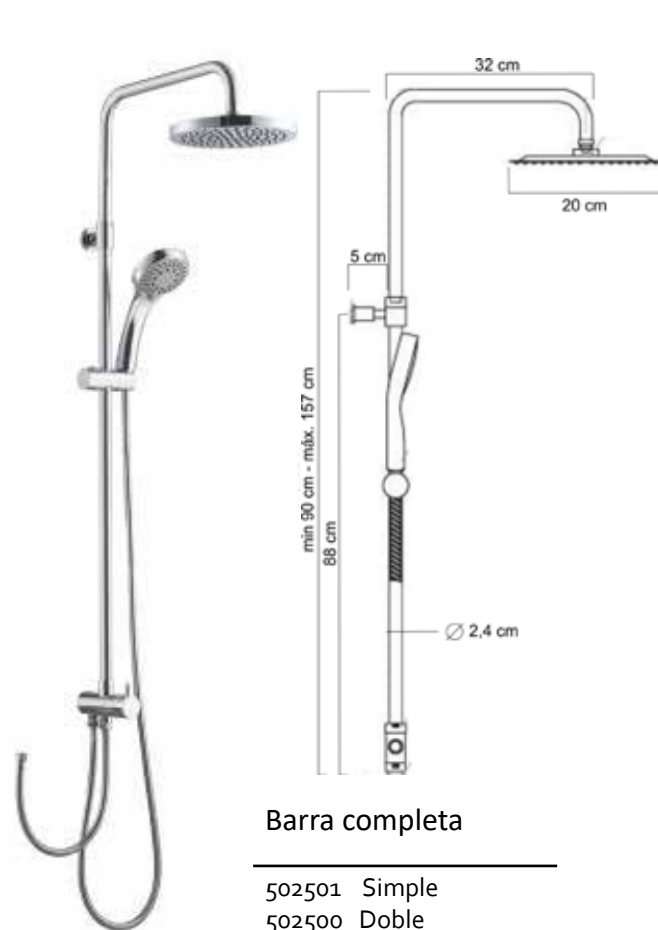

Barra completa

-
- 502501 Simple
 - 502500 Doble



Duchón Inox 20 cm

-
- 502513 Cuadrado
 - 502519 Cuadrado Negro
 - 502515 Redondo
 - 502516 Redondo Bronce



Brazo Duchón

-
- AC251 Redondo
 - AC253 Cuadrado
 - AC252 Cuadrado Negro



Inversor simple/Doble

-
- Invers. Simple**
 - AC841 3/4-1/2-3/4
 - AC844 3/4-1/2-1/2
 - AC845 1/2-1/2-1/2
 - Invers. Doble**
 - AC842 1/2-1/2-3/4





Grifería de Cocinas



Ref: 602218N

**Monomando Fregadero
VERTIX NEGRO**
Cartucho de 35 mm
Apertura Suave
Con conexiones flexibles
8 Unidades caja completa



Ref: 602212N

**Monomando Fregadero
REVO NEGRO**
Cartucho de 35 mm
Apertura Suave
Con conexiones flexibles
8 Unidades caja completa



Ref: 602238N

**Monomando Fregadero
KUBE NEGRO**

Cartucho de 25 mm
Apertura Suave
Con conexiones flexibles
10 Unidades caja completa



Ref: 602230N

**Monomando Fregadero
EXTRAIBLE NEGRO**

Cartucho de 35 mm
Apertura Suave
Con conexiones flexibles
10 Unidades caja completa



Ref: 602252N

**Monomando Fregadero
ROSS NEGRO**

Cartucho de 35mm
Apertura Suave
Con conexiones flexibles
10 Unidades caja completa



Ref: 602226N

**Monomando Fregadero
ABATIBLE NEGRO**

Cartucho de 35mm
Apertura Suave
Con conexiones flexibles
10 Unidades caja completa



Ref: 602254N

**Monoblock Fregadero
Industrial
RUBER NEGRO**

Mango 2 posiciones
Cartucho de 35 mm
Con conexiones flexibles
5 Unidades caja completa



Ref: 602253N

**Monomando Fregadero
EXTRAIBLE LUXOR**

Mango 2 posiciones
Cartucho de 35 mm
Apertura Suave
Con conexiones flexibles
5 Unidades caja completa



Ref: 602212C

**Monomando Fregadero
REVO CROMO**

Cartucho de 35 mm
Apertura Suave
Con conexiones flexibles
8 Unidades caja completa

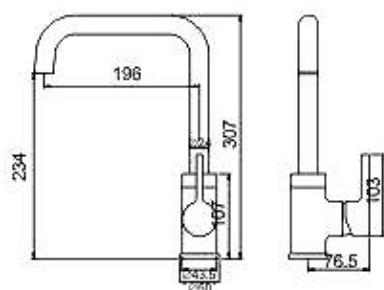

Ref: 602212B

**Monomando Fregadero
REVO BLANCO**

Cartucho de 35 mm
Apertura Suave
Con conexiones flexibles
8 Unidades caja completa

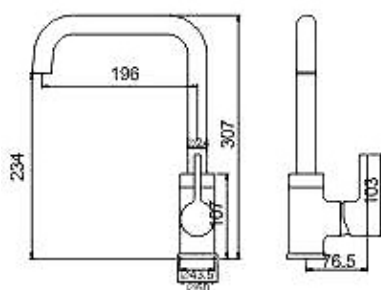

Ref: 602212I

**Monomando Fregadero
REVO INOX**

Cartucho de 35 mm
Apertura Suave
Con conexiones flexibles
8 Unidades caja completa

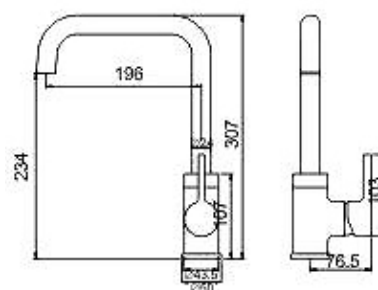

Ref: 602218

**Monomando Fregadero
VERTIX CROMO**

Cartucho de 35 mm
Apertura Suave
Con conexiones flexibles
8 Unidades caja completa

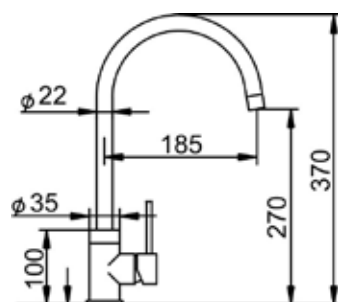

Ref: 602218I

**Monomando Fregadero
VERTIX INOX**

Cartucho de 35 mm
Apertura Suave
Con conexiones flexibles
8 Unidades caja completa

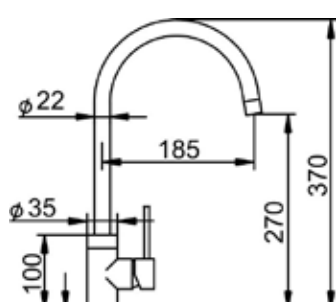

Ref: 602252

**Monomando Fregadero
Inox ROSS**

Cartucho de 35 mm
Con conexiones flexibles
8 Unidades caja completa

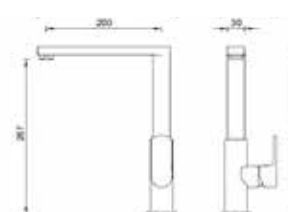



Ref: 602225

Monomando Fregadero OSMOSIS

Cartucho de 35 mm
Montura Apertura Suave
Con conexiones flexibles
8 Unidades caja completa

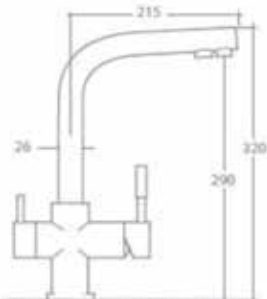

Ref: 602239IN

Monomando Fregadero Industrial NEOX INOX

Mango 2 posiciones
Cartucho de 35mm
Apertura suave
Con conexiones flexibles
5 Unidades caja completa

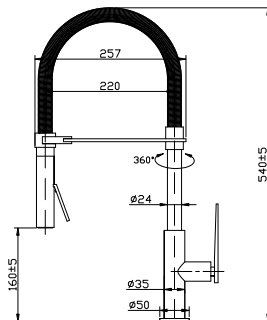

Ref: 602240

Monomando Fregadero INDUS EXTRAIBLE

Flujo 2 posiciones
Cartucho de 35 mm
Con conexiones flexibles
8 Unidades caja completa

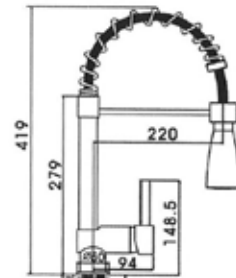

Ref: 602224

Monomando EXTRAIBLE Fregadero TILO

Cartucho de 35 mm
Apertura Suave
Con conexiones flexibles
8 Unidades caja completa

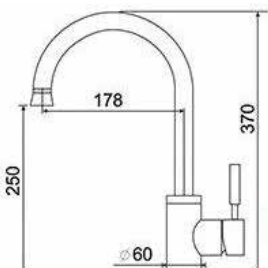

Ref: 602223

Monomando Fregadero Extraible SENSO

Cartucho de 35 mm
Apertura Suave
Con conexiones flexibles
8 Unidades caja completa

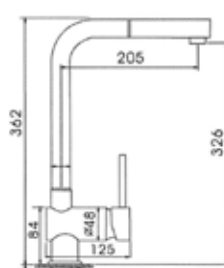

Ref: 602222

Monomando Fregadero Extraible SENTO

Mango 2 posiciones
Cartucho de 35 mm
Apertura Suave
Con conexiones flexibles
8 Unidades caja completa

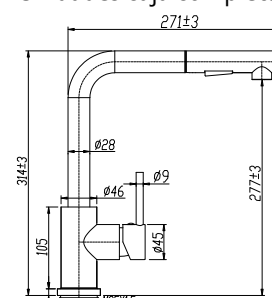



Ref: 602226

**Monomando Fregadero
ABATIBLE**

Cartucho de 40 mm
Apertura Suave
Con conexiones flexibles
8 Unidades caja completa

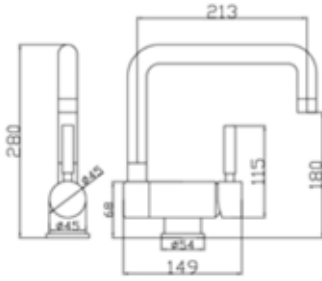

Ref: 602226I

**Monomando Fregadero
ABATIBLE INOX**

Cartucho de 35 mm
Apertura Suave
Con conexiones flexibles
8 Unidades caja completa

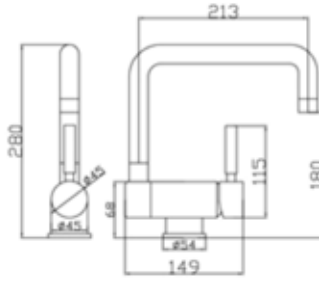

Ref: 602310

**Monoblock Fregadero
GOLDEN CROMO**

Montura Cerámica
Apertura 1/2 vuelta
Con conexiones flexibles
12 Unidades caja completa

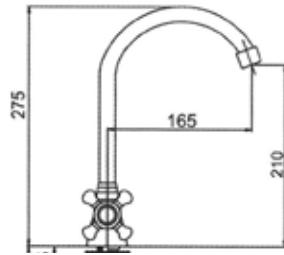

Ref: 602320BR

**Monoblock Fregadero
GOLDEN BRONCE**

Montura Cerámica
Apertura 1/2 vuelta
Con conexiones flexibles
12 Unidades caja completa

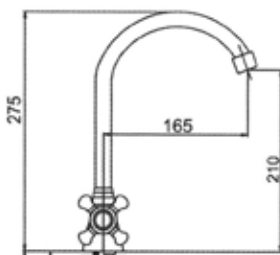

Ref: 602330

**Monoblock Fregadero
GOLDEN RETRO CROMO**

Montura Cerámica
Apertura 1/2 vuelta
Con conexiones flexibles
8 Unidades caja completa

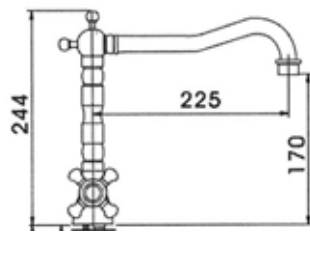

Ref: 602340BR

**Monoblock Fregadero
GOLDEN RETRO BRONCE**

Montura Cerámica
Apertura 1/2 vuelta
Con conexiones flexibles
8 Unidades caja completa

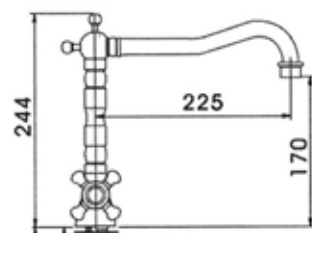



Ref: 602215

Monomando Fregadero RECTO ZENIT

Cartucho de 35 mm
Apertura Suave
Con conexiones flexibles
8 Unidades caja completa

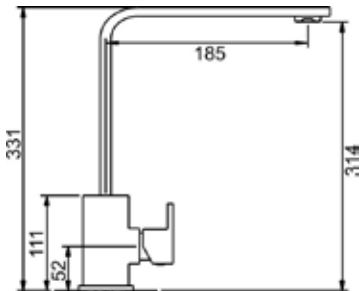

Ref: 602228

Monomando Fregadero CAÑO ALTO FORMA

Cartucho de 40 mm
Apertura Suave
Con conexiones flexibles
12 Unidades caja completa

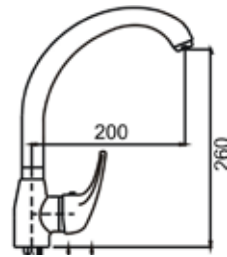

Ref: 602229 Alto
602231 Normal

Monomando Fregadero EXTRAIBLE

Mango 2 posiciones
Cartucho de 40 mm
Apertura Suave
Con conexiones flexibles
12 Unidades caja completa

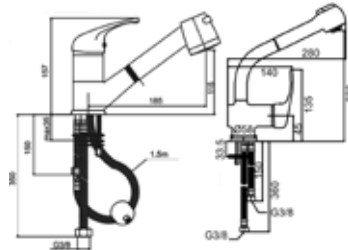

Ref: 602235

Monomando Fregadero CAÑO TUBO

Cartucho de 40mm
Con conexiones flexibles
12 Unidades caja completa

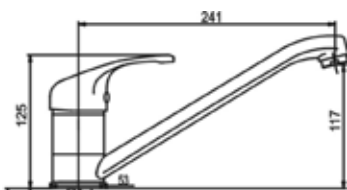

Ref: 602232

Monomando Fregadero CAÑO ALTO FORMA

Cartucho de 40 mm
Apertura Suave
Con conexiones flexibles
12 Unidades caja completa

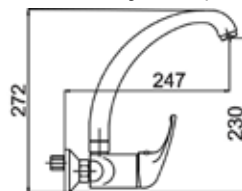



Ref: AC800

Dosificador ABS
Depósito ABS 250 ml
Diseño Redondo

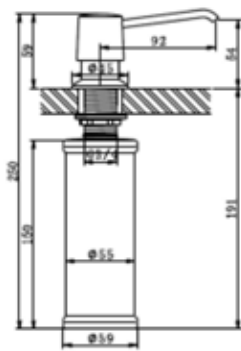

Ref: AC800N

Dosificador ABS
Depósito ABS 250 ml
Diseño Redondo

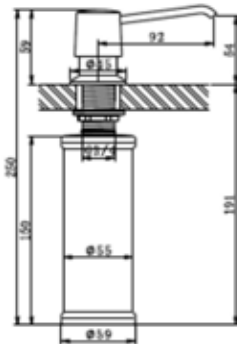

Ref: ESCNegro

Escurridor ROLL UP
Enrollable
37x43 cm

Acero Inoxidable





Fregaderos

Ref:CUBMU68

Cubeta Multifunción Completa
 Medidas 68x45 cm
 Hueco de Encastre 65x42cm



CONTENIDO



Seno de Fregadero

Acero inoxidable 304
 22cm de profundidad
 Surcos "fast drain"
 Anti manchas



Grifo Extraible

Selector de chorro
 Dial de apertura
 Selección cascada o grifo



Limpia vasos

Activación por presión
Multijets



Cubeta individual

Con desagüe independiente
Deslizable
Extraible



Grifo agua filtrada

No incluye filtro



Escurreidor individual

De acero
Deslizable
Extraible

Se suministran con válvula de cestilla y sifón según modelo



Ref: CUB40X40

Fregadero 40x40
 Multiposición
 Sobre o bajo encimera

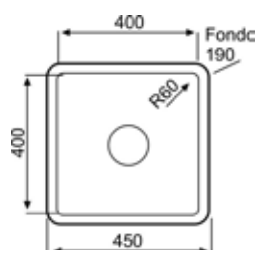

Ref: CUB45X40

Fregadero 40x45
 Multiposición
 Sobre o bajo encimera

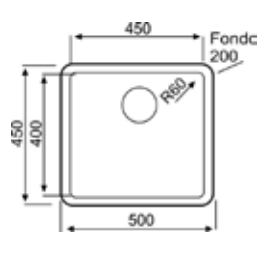

Ref: CUB50X40

Fregadero 40x50
 Multiposición
 Sobre o bajo encimera

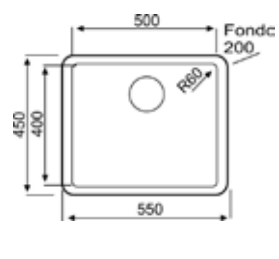

Ref: CUB40X40R15

Fregadero 40x40
 RADIO 19-10
 Multiposición

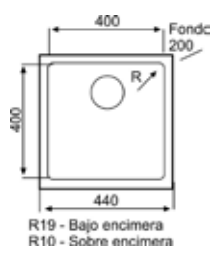

Ref: CUB45X40R15

Fregadero 40x45
 RADIO 19-10
 Multiposición

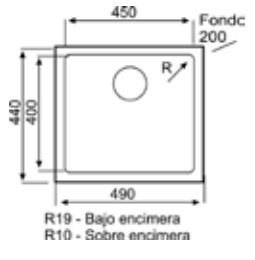

Ref: CUB50X40R15

Fregadero 50x40
 RADIO 19-10
 Multiposición

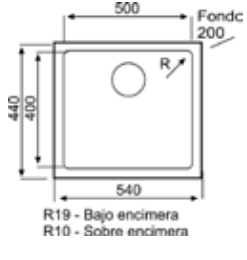



Ref: CUB85X40D

**Fregadero
CUBETA Y
ESCURRIDOR
CUADRADO**
Sobre encimera

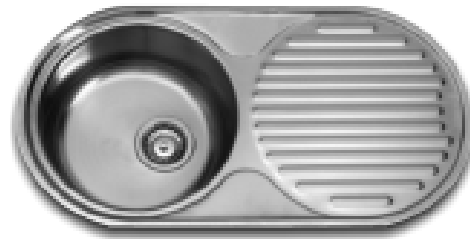
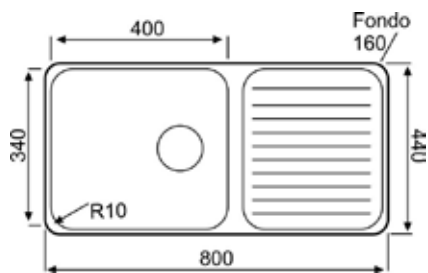

Ref: CUB80X45

**Fregadero
CUBETA CON
ESCURRIDOR**
Sobre encimera

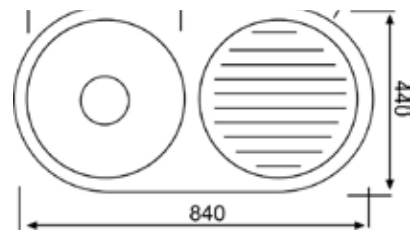

Ref: CUB80X2

**Fregadero
2 CUBETAS
REDONDO**
Sobre encimeraa

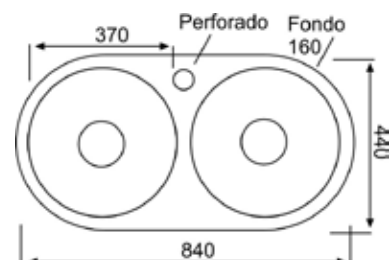





Accesorios

	Referencia	Color
	A440 Fijo Conventional Un agua 60 unidades caja	Cromo
	A1028C Fregadero Conventional Un agua 24 unidades caja	Cromo
	A450 Lavabo mono-mando Un agua 30 unidades caja	Cromo
	A1029C Fregadero 15" Caño tubo 12 Unidades caja completa	Cromo
	A1032C Fregadero 11" Caño tubo 12 Unidades caja completa	Cromo
	A1030C Freg. pared horizontal 24 Unidades caja completa	Cromo
	A1031C Freg. pared vertical 24 Unidades caja completa	Cromo
	AC500 Soporte UNI	Cromo
	AC501 Soporte SUIT	Cromo

	Referencia	Color
	AC508 Soporte GOLDEN	Cromo
	AC508BR	Bronce
	Soporte BLOCK AC503	Cromo
	AC504	Negro
	AC902 Barra Ducha BASIC	Cromo
	AC601 Flexo Extensible 1,70 - 2,20m	Cromo
	AC603X	Bronce
	AC602 Flexo 45cm	Cromo
	AC604 Flexo Macho Hembra 1,50m	Cromo
	AC605 Flexo Macho Macho 2 m	Cromo
	AC609 Flexo 1,50 cm	Negro

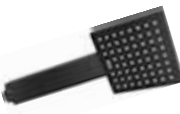
	Referencia	Color
	AC401 Mango 1 Posición	Cromo
	AC404 Mango OMNI 3 Posiciones	Cromo
	AC408 Mango GOLDEN	Cromo
	AC408BR Mango GOLDEN	Bronce
	AC417N Mango Negro	Negro

	Referencia	Color
	AC406 Mango AURA	Cromo
	AC407 Mango ZENIT	Cromo
	AC422 Mango Industrial FREG. REFORZADO	Cromo
	AC421 Mango INDUS 2 posiciones	Cromo
	AC430 Mango Fregadero Extraible 2 posiciones	Cromo
	AC801 Conjunto Latiguillos	Cromo
	AC802 Latiguillo Fregadero Ext. 15cm	Cromo

	Referencia	Color
	Conjunto EXCENTRICA AC810	Cromo
	AC810BR	Bronce
	Conjunto EXC. GRANDE AC814	Cromo
	AC812	Cromo
	Conjunto EXCENTRICA Diseño AC813	Cromo
	Conjunto EXCENTRICAS Cuadradas	

	Referencia	Color
	Vál. ClickClac DUAL AC112	Cromo
	AC112BR	Bronce
	AC710 Sifón UNI	Cromo
	AC711N Sifón Recto NEGRO	Negro



	Descripción	Referencia
	Cartucho 40mm s/libre	AC40L
	Cartucho 40mm s/fija	AC40P
	Cartucho 25mm s/fija	AC25P
	Cartucho 35mm s/libre	AC35L
	Cartucho 35mm s/fija	AC35P
	Cartucho Termostático VEGA	AC860
	Cartucho Termostático BASS	AC861
	Cartucho Temporizado Lavabo	AC862
	Montura convencional 1/2 zapatilla	AC850
	Montura cerámica (Golden)	AC851
	Montura 1/2 cerámica (1/4 vuelta)	AC852
	Montura Osmosis	AC856
	Conjunto de sujeción	AC830
	Conjunto de sujeción doble	AC831
	Conjunto sujec. esparrago largo	AC832
	Inversor Varios	AC843
	Volante Golden CR	AC89
	Volante Golden BR	AC89BR
	Maneta Niza	AC98
	Maneta medical CR (40)	AC10
	Maneta Aura	AC93
	Aireador Macho 18mm	AC880M18
	Aireador Macho 22mm	AC880M22
	Aireador Macho 24mm	AC880M24
	Aireador Macho 28mm	AC880M28
	Aireador Macho 24mm BR	AC881M24B
	Aireador Hembra 18mm	AC881M18
	Aireador Hembra 20mm	AC881M20
	Aireador Hembra 22mm	AC881M22
	Aireador Hembra 22mm BR	AC881M22B
	Aireador rótula CR	AC882
	Aireador rótula BR	AC882B
	Casquillo Golden CR	AC88
	Casquillo Golden BR	AC88BR



Recomendaciones y mantenimiento

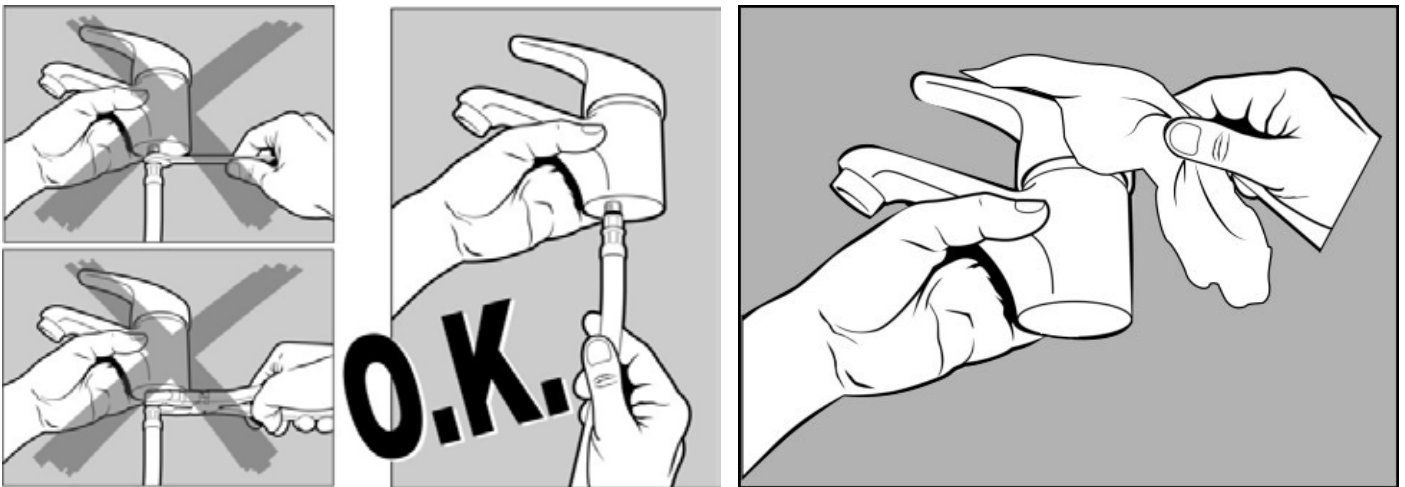

Las conexiones flexibles se colocarán girando con la mano, sin necesidad de herramienta alguna. Una vez queden firmemente ajustadas será suficiente y seguro.

Para su limpieza emplee tan sólo agua o agua jabonosa, no excesivamente caliente.

Frote con una bayeta suave y procure secarlo después.

Evite que la cal se deposite o produzca manchas.

Una vez seca la cal será muy difícil de eliminar sin dañar los recubrimientos.

Nunca deben limpiarse con sulfumán o cualquier otro producto abrasivo.

Incluso los vapores de estos productos pueden dañar irreparablemente los cromados.

Condiciones de Venta

PRECIOS

Los precios se entienden en nuestro almacén siendo los portes, el IVA y el acarreo, a cargo del comprador salvo que se indique lo contrario.

PORTES

Pedidos inferiores a 200 Euros en península se cargará en factura 10 € en concepto de Transporte. Pedidos inferiores a 1200 Euros en Canarias, Baleares, Ceuta y Melilla se cargará en factura 45 €.

RECLAMACIONES

Las eventuales reclamaciones, así como defectos de fabricación deberán comunicarse dentro de los 15 días siguientes a la recepción de la mercancía por el comprador.

GARANTÍA*

Se repararán o sustituirán aquellas piezas que presenten defectos atribuibles al proceso de fabricación siempre que no hayan sido objeto de uso o manipulación indebida por parte del usuario. Las garantías para acabados especiales tales como bronce, cromo-mate, etc, son de UN AÑO.

PROPIEDAD DE LA MERCANCÍA

La empresa se reserva el derecho de la propiedad de la mercancía suministrada, hasta que el comprador no haya satisfecho totalmente el importe de la misma. La mercancía, podrá ser retirada por incumplimiento de pago en el plazo previamente estipulado.

CONDICIONES DE PAGO

El aplazamiento máximo de pago de nuestras facturas, será de 60 días ff. En caso de diferirse el pago serán a cargo del comprador los gastos de negociación de efectos, o bien los intereses legales especificados.

LITIGIOS

En caso de litigios, ambas partes aceptan someter sus diferencias a los juzgados y tribunales de Sevilla. La empresa se reserva la facultad de cambiar en todo o en parte el diseño y materiales, de cualquiera de sus productos.



CARSO - LABORATOIRE SANTÉ ENVIRONNEMENT HYGIÈNE DE LYON

Laboratoire Agréé pour les analyses d'eaux par le Ministère de la Santé

ATTESTATION DE CONFORMITE SANITAIRE

Conformément à l'arrêté du 29 mai 1997 modifié et à la circulaire du Ministère de la santé DGS/SD7A 2002 n°571 du 25 novembre 2002

Nom de l'accessoire représentatif : Cartouche céramique D35P-1
 D22PF-1 D35P-1
 D25PF-1 D35PC-1
 N° de dossier attribué par le laboratoire habilité : 10 ACC LY 082
 D26PF-1 D40P-1
CARTOUCHE THERMOSTATIQUE 99014-H
 D33PF-1 D40PC-1
 D36PF-1 D40GS-1

Date de réalisation des essais d'inertie, le cas échéant : du 23 Mars au 16 Juin 2010
 Commentaires : Les résultats des essais menés sur l'accessoire critique sont conformes aux critères d'acceptabilité fixés par la circulaire n° 571 du 25.11.2002.

Attestation délivrée par : Christelle AUTUGELLE
 Responsable Laboratoire MCDE
 CARSO - L.S.E.H.L. Signature :

A la date du : 16 Juin 2010
 Date d'expiration de l'ACS : 16 Juin 2015

La empresa con NIPC: 44078374802689

Declaro bajo su responsabilidad que los productos de grifería que fabrica y son relacionados a continuación, son conformes a la directiva:

89/106 CEE (PRODUCTOS DE CONSTRUCCIÓN)

Y a la norma a la que remite la NORMA 19703:2003.

UNE EN 817

Y así mismo hace extensiva la normativa UNE EN817, mediante la que homologa todos sus fabricados, a la empresa EG GRIFERIA, SL, con sede social en Dos Hermanas, Sevilla (España) con CIF: B9C244542, para que aún denominando bajo otro código o referencia al mismo producto, este quede acogido a las garantías correspondientes.

Kaiping, 25/02/2016



Organisme certificateur

CERTIFICAT

Flexibles de raccordement

Décision n° 102-20-1122 du 28 novembre 2007
 attachée à l'Avis Technique n° 14/07-1122

Cette décision annule et remplace la décision n° 97-20-671 du 5 avril 2007

Sur proposition du comité d'évaluation, le produit :
SEDAL SA

De la société : SEDAL
 Avda. Barcelona 264 Polígono Industrial El Pla
 ES - 08750 MOLINS DE REI (Barcelona)
 Usine de : ES - 08750 MOLINS DE REI (Barcelona)

bénéficie de la marque CSTBat en application des exigences générales de la certification CSTBat et du règlement technique n°19. Cette décision atteste que le produit ci-dessus est certifié conformément à ces référentiels.

FLEXIBLES DE RACCORDEMENT SOUPLES



Yannick LENOIR

CARACTÉRISTIQUES CERTIFIÉES

Conformité à l'Avis Technique n°14/07-1122

Caractéristiques physiques et physico-chimiques de l'Aluminate

- dureté
- résistance à la rupture
- allongement à la rupture
- déformation résiduelle après compression
- variations de dureté et des caractéristiques en traction après vieillissement
- tenue à l'ozone

Caractéristiques mécaniques des produits finis

- résistance à la pression à 20°C et 80°C, à 3 fois la pression maximale admissible

Ce certificat comporte : 1 page.
 Code produit : Eliane ROUSSEAU
 Tél. : 01 64 68 82 84
 Fax : 01 64 68 84 44

Seul retrait, suspension ou modification, se doit d'être de ce certificat est reconnu sous les 23 mm.
 La date des certificats est limitée à deux ans CSTB et disponible sur le site internet www.cstb.fr.
 Quelque présente ce certificat doit également présenter la version l'Avis Technique correspondant.



CENTRE SCIENTIFIQUE ET TECHNIQUE DU NATIUM
 8888 BOULEVARD DE LA REINE JEANNE D'ARC | CHAMPS-SUR-ARRENS | 77447 MARNO-LA-VALLEE (SEINE-ET-MARNE)
 TEL. 03 03 84 84 84 84 | FAX. 03 03 84 84 84 84 | www.cstb.fr
 MARNO-LA-VALLEE | PARIS | GRENOBLE | NANTES | STRASBOURG-ANCIENNES

AENOR Product Certificate
 Plastics



001/006279

AENOR, Spanish Association for Standardization and Certification, confirms that the organization

FLEXITUB, S.L.

Address: U/I. JEAN RAMON BARRINEZ, 17 DENIA MONTANET DE L'ESPAGNE (Balearic Islands - Spain)

Product: Flexible hoses assemblies in drinking water installations

in compliance with UNE-EN 13028:2011 (EN 13018:2011)

TRADE MARK: FLEXITUB EG
 TECHNICAL CLASSIFICATION (China Classification): OTHER PIPE MATERIAL
 BRAND NAME: AENOR INODORABLE
 EXTENSION AND TYPE OF THREAD: G 1/2", G 3/4", G 1", G 1 1/4", G 1 1/2", G 2", G 2 1/2", G 3", G 3 1/2", G 4", G 4 1/2", G 5", G 5 1/2", G 6", G 6 1/2", G 8", G 10", G 12", G 15", G 20", G 25", G 32", G 40", G 50", G 63", G 80", G 100", G 125", G 160", G 200", G 250", G 315", G 400", G 500", G 630", G 800", G 1000

Production site: SHANGHAI ROAD, 1, CDD ECONOMIC DEVELOPMENT ZONE 151498 (SHANGHAI ECONOMIC DEVELOPMENT ZONE, Zhejiang - China)

Certification scheme: In order to grant this Certificate, AENOR has tested the product and has verified the quality system implemented for its manufacture. AENOR performs these tests periodically while the Certificate has not been cancelled, in accordance with Specific Rules RP-73.05.

Exp. issued on: 2014-09-15
 Validity date: 2024-09-15

[Signature]
 AENOR
 Javier SÁIZO
 Chief Executive Officer

AENOR Asociación Española de Normalización y Certificación | Avda. B. 8025, Madrid, España | Tel. 912 021 201 - www.aenor.es



ESCANEAME PARA
VER LA ÚLTIMA VERSIÓN DE NUESTRA TARIFA



AV. VIRGEN DE LOS DESAMPARADOS NAVE 8
41701 DOS HERMANAS (SEVILLA)
TELÉF 955 292 296
MAIL: pedidos@eggriferia.es
www.eggriferia.es





Catálogo Grifería 2023

