

CATÁLOGO EN LÍNEA
ONLINE CATALOGUE



OFICINAS Y CENTRO LOGÍSTICO
OFFICES AND LOGISTICS CENTER
Polígono Industrial Girona | C. Morera, 6
17457 Riudellots de la Selva (Girona) Spain
Tel. 972 478 427 / Fax 972 477 714
comercial@mirtak.com

FÁBRICA
FACTORY
Polígono Industrial San Miguel
C. Isaac Newton, 18
50830 Villanueva de Gallego (Zaragoza) Spain

www.mirtak.com



MIXERS | ROBINETS | TORNEIRAS
COLLECTION 21 | 22

Griferia
mirtak



Griferia
mirtak
COLLECTION 21 | 22

Water is the Future





SIENTE SU BIENESTAR

Nos calma, nos relaja y evade cuando la sentimos, el agua es bienestar.

Del bienestar, surge nuestro compromiso en querer ofrecer un entorno ideal para disfrutar de ella.

Al igual que el agua se compone de dos elementos. Nuestros valores también residen en dos elementos esenciales: *Diseño y Sostenibilidad.*

Valores que, permitirán a nuestros clientes, sentir el bienestar en los productos que aquí se presentan.

FEEL THE WELL-BEING

It calms us, relaxes us and evades when we feel it, water is well-being.

From well-being comes our commitment. In creating the ideal environment to enjoy it.

Like water is made up of two elements. Our values are also made up of two essential elements: *Design and Sustainability.*

Essential values, that will allow our customers to feel the well-being in the products we introduce in this collection.

PASIÓN POR EL FLUIR DEL AGUA PASION FOR THE WATER FLOW

INTERIOR DE UN MONOMANDO LAVABO INTERIOR OF A SINGLE LEVER MIXER

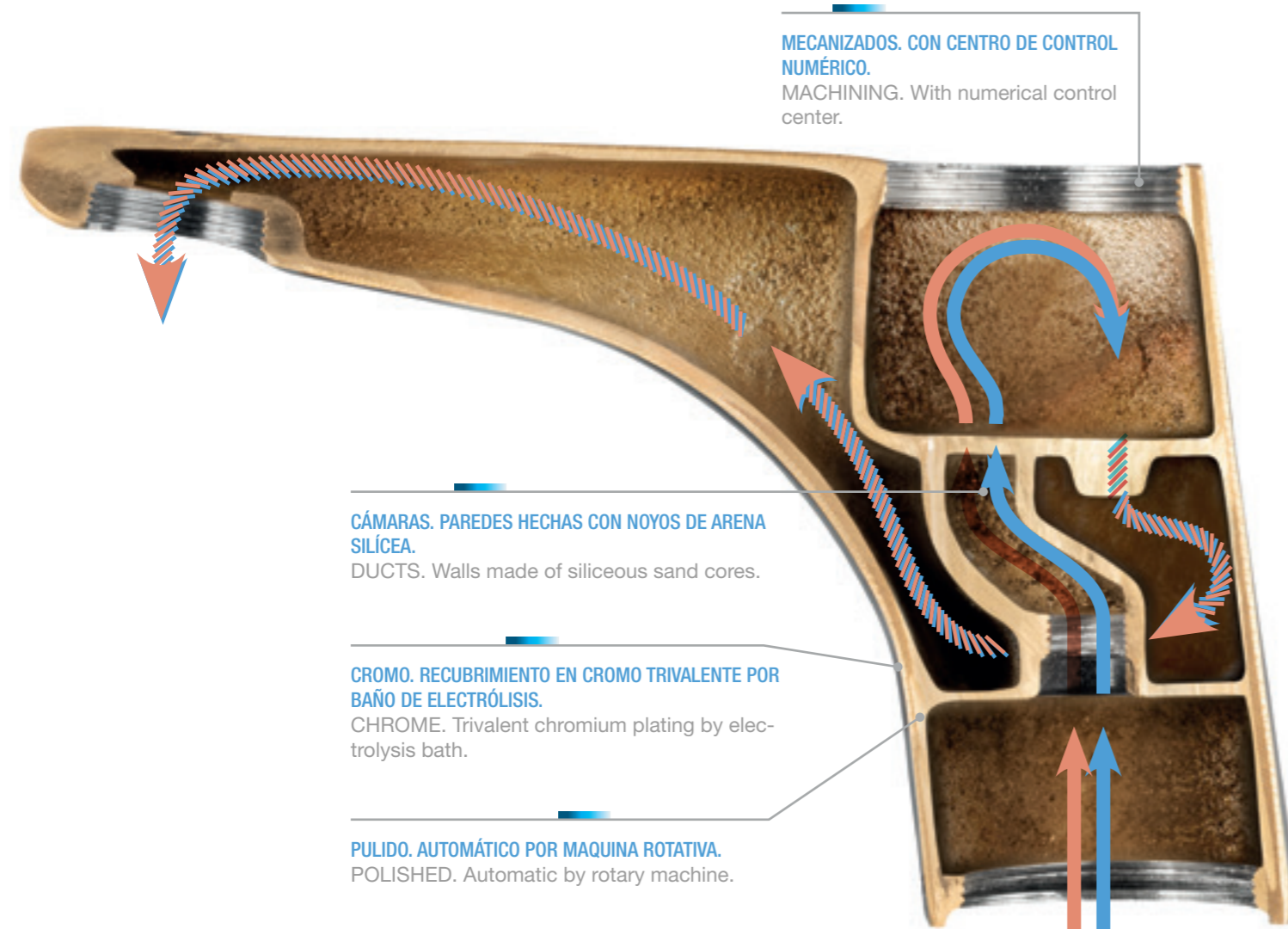

MECANIZADOS. CON CENTRO DE CONTROL NUMÉRICO.
MACHINING. With numerical control center.

CÁMARAS. PAREDES HECHAS CON NOYOS DE ARENA SILÍCEA.
DUCTS. Walls made of siliceous sand cores.

CROMO. RECUBRIMIENTO EN CROMO TRIVALENTE POR BAÑO DE ELECTRÓLISIS.
CHROME. Trivalent chromium plating by electrolysis bath.

PULIDO. AUTOMÁTICO POR MAQUINA ROTATIVA.
POLISHED. Automatic by rotary machine.

LIMADO. ARTESANAL.
FILED. Handcrafted.

PINTURA. ACABADO CON PINTURA NEGRA MATE POR HORNEADO A + 300°.
PAINTING. Finished with matte black paint on oven at + 300°.

COMPONENTES EN NUESTRA GRIFERÍA DETAILED PARTS IN OUR MIXERS

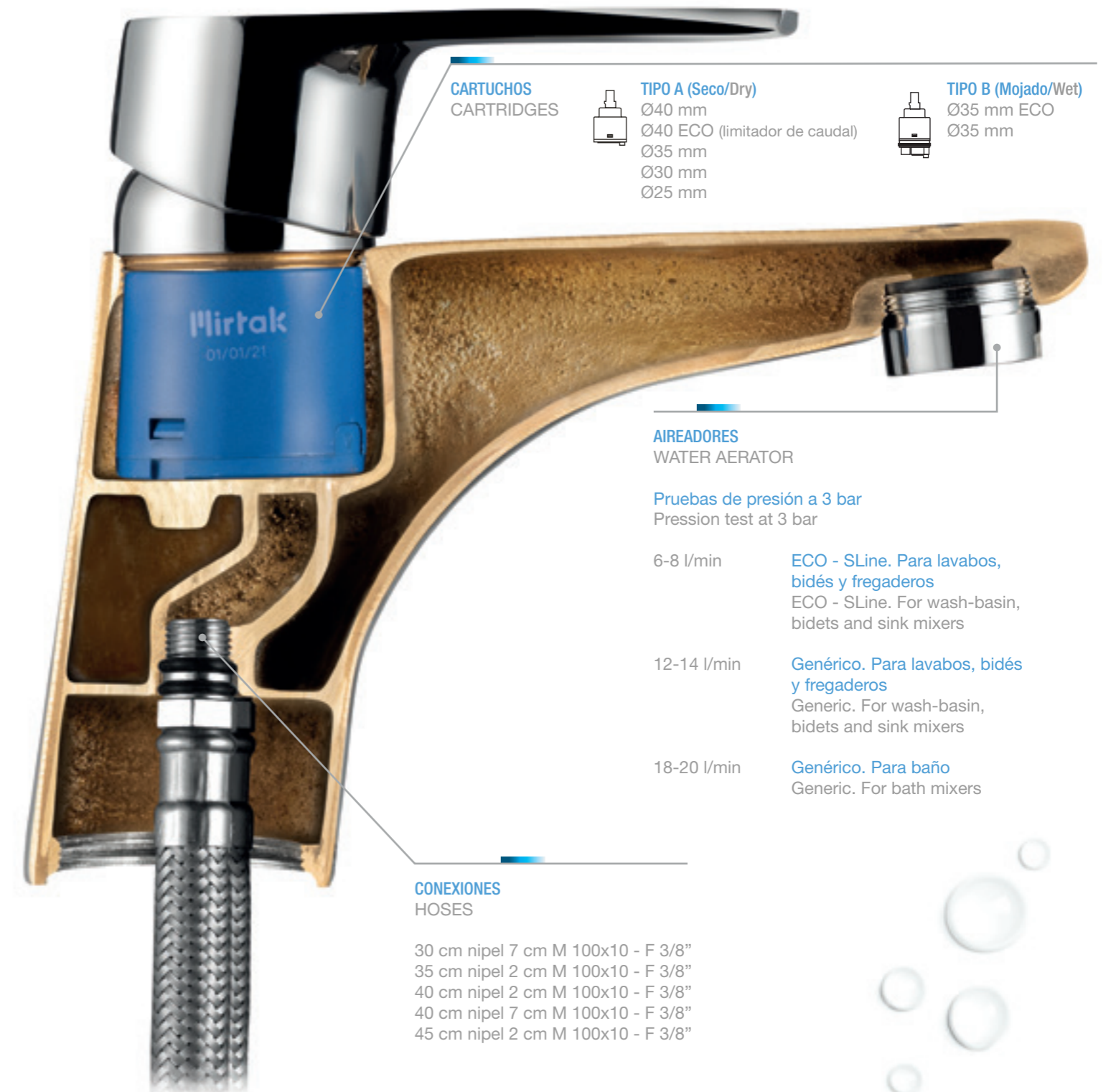

**CARTUCHOS
CARTRIDGES**

TIPO A (Seco/Dry)
Ø40 mm
Ø40 ECO (limitador de caudal)
Ø35 mm
Ø30 mm
Ø25 mm

TIPO B (Mojado/Wet)
Ø35 mm ECO
Ø35 mm

**AIREADORES
WATER AERATOR**

Pruebas de presión a 3 bar
Pression test at 3 bar

6-8 l/min **ECO - SLine. Para lavabos, bidés y fregaderos**
ECO - SLine. For wash-basin, bidets and sink mixers

12-14 l/min **Genérico. Para lavabos, bidés y fregaderos**
Generic. For wash-basin, bidets and sink mixers

18-20 l/min **Genérico. Para baño**
Generic. For bath mixers

**CONEXIONES
HOSES**

30 cm nipel 7 cm M 100x10 - F 3/8"
35 cm nipel 2 cm M 100x10 - F 3/8"
40 cm nipel 2 cm M 100x10 - F 3/8"
40 cm nipel 7 cm M 100x10 - F 3/8"
45 cm nipel 2 cm M 100x10 - F 3/8"

EL AGUA

The WATER

“És la fuente de vida
de todo organismo”
“Is the source of life
for all living beings”



Solo el
Only the

1%

del agua en el mundo,
és POTABLE.
of the worldwide water,
is DRINKABLE.

Por ello, hay que disfrutarla y a la vez preservarla.
Therefore, we should enjoy it while preserving it.

*Compromiso
Mirtak*

LA OPCIÓN SOSTENIBLE
THE SUSTAINABLE OPTION

SLINE
by Mirtak

SERIES CON OPCIÓN A SLINE
SERIES WITH SLINE OPTION



De consumo en agua
Water consumption

Incluido con la opción SLINE
Included with SLINE option

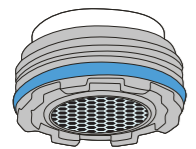

ATOMIZADOR
WATER AERATOR

Compatible con lavabos,
fregaderas y bidets
Compatible with wash-basin,
sink and bidets mixers

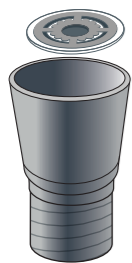

REDUCTOR FLEJO
HOSE REDUCTOR

Compatible con duchas
y baños
Compatible with shower
and bath mixers

CONSUMO
CONSUMPTION

6-8 l/min*

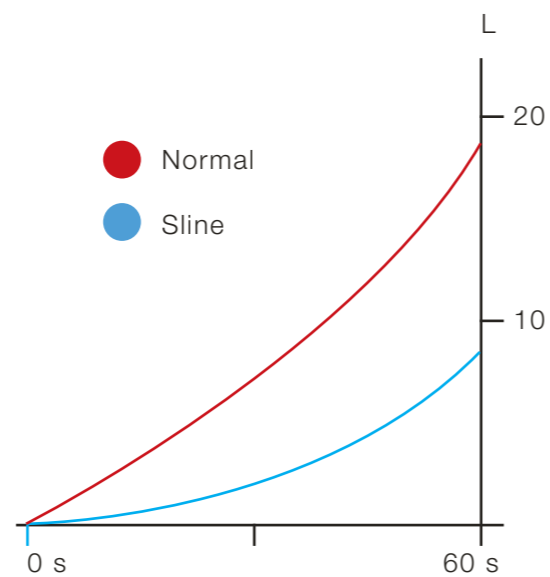

Water is the Future

*Pruebas de presión a 3 bar / *Pression test at 3 bar

ESPACIO MIRTAK SPACE



Mirtak
Griferia

SLINE

<p>COLUMNAS MONOMANDO SINGLE LEVER SHOWER COLUMNS</p> 	<p>SPACE Baño P. 16</p> 	<p>SPACE Ducha P. 18</p> 	<p>VOLTA Black P. 20</p> 	<p>TENNA P. 22</p> 
---	---	--	---	--

<p>CENTURY P. 24</p> 	<p>QUADRO P. 26</p> 	<p>ARAL P. 28</p> 	<p>NAVY P. 30</p> 	<p>MAXI P. 32</p> 
--	---	---	--	---

<p>COLUMNAS TERMOSTÁTICAS THERMOSTATIC SHOWER COLUMNS</p> 	<p>SQ-77 P. 34</p> 	<p>VULKAN P. 36</p> 	<p>MAXI-2 P. 38</p> 
---	--	---	--

<p>COLUMNAS BIMANDO TWO-HANDLE SHOWER COLUMNS</p> 	<p>STILO P. 40</p> 
---	--

<p>S LINE</p>	<p>SVELTA P. 44</p> 	<p>SVELTA BLACK P. 48</p> 	<p>VEGA P. 52</p> 	<p>YUKON P. 56</p> 
---------------	---	---	--	--

<p>TENNA P. 60</p> 	<p>MAIA P. 64</p> 	<p>MAIA BLACK P. 68</p> 
--	---	---

<p>essence by Mirtak</p>	<p>BEST P. 74</p> 	<p>CENTURY P. 78</p> 	<p>STILO P. 82</p> 	<p>NEVA P. 86</p> 
--------------------------	---	--	--	---

<p>NAVY P. 90</p> 	<p>OASIS P. 94</p> 	<p>MEDICAL P. 100</p> 
---	--	---

<p>GRIFERÍA COCINA KITCHEN MIXERS P. 104</p> 	<p>GRIFERÍA TERMOSTÁTICA THERMOSTATIC MIXERS P. 118</p> 	<p>GRIFERÍA ELECTRÓNICA ELECTRONIC MIXERS P. 122</p> 
--	---	--

<p>GRIFERÍA TEMPORIZADA Y PEDALES TIMER TAPS & PEDALS P. 126</p> 	<p>GRIFERÍA EMPOTRADA BUILD-IN MIXERS P. 132</p> 	<p>COMPLEMENTOS DUCHA SHOWER ACCESSORIES P. 138</p> 
--	--	---

<p>SISTEMAS HIDROSANITARIOS HIDROSANITARY SYSTEMS P. 148</p> 	<p>ACCESORIOS ACCESSORIES P. 152</p> 	<p>EXPOSITORES DISPLAYS P. 162</p> 
--	--	--

<p>RECAMBIOS GRIFERÍA MIXER REPLACEMENTS P. 174</p> 

COLUMNAS
DE DUCHA
SHOWER
COLUMNS



DETALLES TÉCNICOS EN
Technical details in
Détails techniques dans
Detalhes técnicos na
P. 180



REF. 68079

MONOMANDO

Columna ducha / baño

SPACE Baño

Single-lever
Mitigeur
Monocomando

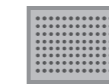

ROCIADOR
280 x 190 mm



MANGO 3 POSICIONES

Shower Handle 3 positions
Poignée 3 positions
Chuveiro 3 posições



AISI 304



LOW SOUND

BARRA AISI 304 REGULABLE EN ALTURA
Adjustable height AISI 304 bar
Barre AISI 304 réglable en hauteur
Barra AISI 304 ajustável em altura

SOPORTE DUCHA DESLIZANTE
Slider shower holder
Support de douche coulissant
Suporte deslizante de chuveiro



INVERSOR INTEGRADO EN LA GRIFERÍA

Inverter built in the mixer
Inverseur intégré dans le robinet
Inversor integrado na torneira



CAÑO GIRATORIO + CIERRE CERÁMICO

Swivel spout & ceramic closure
Bec pivotante et fermeture céramique
Bica giratória e fechamento cerâmico



Columna
SPACE Ducha

DETALLES TÉCNICOS EN

Technical details in
Détails techniques dans
Detalhes técnicos na
P. 180



REF. 68078

MONOMANDO

Columna ducha
SPACE Ducha

Single-lever
Mitigeur
Monocomando



ROCIADOR
280 x 190 mm



MANGO 3 POSICIONES
Shower Handle 3 positions
Poignée 3 positions
Chuveiro de 3 posições



AISI 304

BARRA AISI 304 REGULABLE EN ALTURA
Adjustable height AISI 304 bar
Barre AISI 304 réglable en hauteur
Barra AISI 304 ajustável em altura



LOW SOUND

SOPORTE DUCHA DESLIZANTE
Slider shower holder
Support de douche coulissant
Suporte deslizante de chuveiro



INVERSOR INTEGRADO EN LA GRIFERÍA
Inverter built in the mixer
Inverseur intégré dans le robinet
Inversor integrado na torneira



Water is the Future

Griferia



DETALLES TÉCNICOS EN
Technical details in
Détails techniques
dans
Detalhes técnicos na
P. 180



REF. 68063

MONOMANDO

Columna ducha
VOLTA Black

Single-lever
Mitigeur
Monocomando



ROCIADOR SLIM 2 mm
ACERO INOX Ø20 mm



Stainless Steel Slim Sprayer
Pulvérisateur mince en acier inoxydable
Pulverizador no em aço inoxidável



MANGO 3 POSICIONES

Shower Handle 3 positions
Poignée 3 positions
Chuveiro 3 posições



AISI 304

BARRA AISI 304 REGULABLE EN ALTURA

Adjustable height AISI 304 bar
Barre AISI 304 réglable en hauteur
Barra AISI 304 ajustável em altura



LOW SOUND

SOPORTE DUCHA DESLIZANTE

Slider shower holder
Support de douche coulissant
Suporte deslizante de chuveiro



INVERSOR INTEGRADO EN LA GRIFERÍA

Inverter built in the mixer
Inverseur intégré dans le robinet
Inversor integrado na torneira



DETALLES TÉCNICOS EN
Technical details in
Détails techniques dans
Detalhes técnicos na
P. 180



REF. 68090

MONOMANDO

Columna ducha
TENNA

Single-lever
Mitigeur
Monocomando

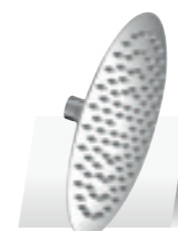

ROCIADOR SLIM 2 mm
ACERO INOX Ø20 mm

AISI 304

Stainless Steel Slim Sprayer
Pulvérisateur mince en acier inoxydable
Pulverizador no em aço inoxidável



MANGO 3 POSICIONES

Shower Handle 3 positions
Poignée 3 positions
Chuveiro 3 posições



LATÓN BRASS

BARRA LATÓN REGULABLE EN ALTURA

Adjustable height brass bar
Barre en laiton réglable en hauteur
Barra de latão ajustável em altura



LOW SOUND

SOPORTE DUCHA DESLIZANTE

Slider shower holder
Support de douche coulissant
Suporte deslizante de chuveiro



INVERSOR CERÁMICO

Ceramic inverter
Onduleur céramique
Inversor cerâmico



DETALLES TÉCNICOS EN
Technical details in
Détails techniques dans
Detalhes técnicos na
P. 180



REF. 68048

MONOMANDO

Columna ducha
CENTURY

Single-lever
Mitigeur
Monocomando

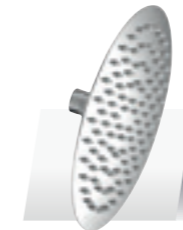

ROCIADOR SLIM 2 mm
ACERO INOX Ø20 mm

AISI 304

Stainless Steel Slim Sprayer
Pulvérisateur mince en acier inoxydable
Pulverizador no em aço inoxidável



MANGO 3 POSICIONES

Shower Handle 3 positions
Poignée 3 positions
Chuveiro 3 posições



LATÓN BRASS

BARRA LATÓN REGULABLE EN ALTURA
Adjustable height brass bar
Barre en laiton réglable en hauteur
Barra de latão ajustável em altura



LOW SOUND

SOPORTE DUCHA DESLIZANTE
Slider shower holder
Support de douche coulissant
Suporte deslizante de chuveiro



INVERSOR CERÁMICO

Ceramic inverter
Onduleur céramique
Inversor cerâmico



Columna
QUADRO

DETALLES TÉCNICOS EN
Technical details in
Détails techniques
dans
Detalhes técnicos na
P. 180



REF. 68076

MONOMANDO

Columna ducha
QUADRO

Single-lever
Mitigeur
Monocomando

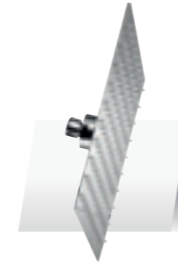

ROCIADOR SLIM 2 mm
ACERO INOX 200 x 200 mm

AISI 304
Slim Sprayer Stainless steel
Pulvérisateur mince en acier inoxydable
Pulverizador fino em aço inoxidável

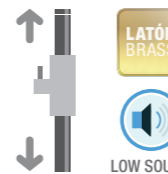

LATÓN BRASS
BARRA LATÓN REGULABLE EN ALTURA
Adjustable height brass bar
Barre en laiton réglable en hauteur
Barra de latão ajustável em altura

LOW SOUND



SOPORTE DUCHA DESLIZANTE
Slider shower holder
Support de douche coulissant
Suporte deslizante de chuveiro



INVERSOR CERÁMICO
Ceramic inverter
Inverseur céramique
Inversor cerâmico



Water is the Future

Griferia

DETALLES TÉCNICOS EN
Technical details in
Détails techniques
dans
Detalhes técnicos na
P. 180



REF. 68073

MONOMANDO

Columna ducha
ARAL

Single-lever
Mitigeur
Monocomando



ROCIADOR CROMO/BLANCO
225 x 250 mm

Chrome / White Sprayer
Pulvérisateur Chrome-Blanc
Sprinkler Cromado - Branco



MANGO 3 POSICIONES

Shower Handle 3 positions
Poignée 3 positions
Pega do chuveiro de 3 posições



**LATÓN
BRASS**

BARRA LATÓN REGULABLE EN ALTURA

Adjustable height brass bar
Barre en laiton réglable en hauteur
Barra de latão ajustável em altura



LOW SOUND

SOPORTE DUCHA DESLIZANTE

Slider shower holder
Support de douche coulissant
Suporte deslizante de chuveiro



INVERSOR CERÁMICO

Ceramic inverter
Onduleur céramique
Inversor cerâmico



DETALLES TÉCNICOS EN
Technical details in
Détails techniques
dans
Detalhes técnicos na
P. 181



REF. 68080

MONOMANDO

Columna ducha
NAVY

Single-lever
Mitigeur
Monocomando

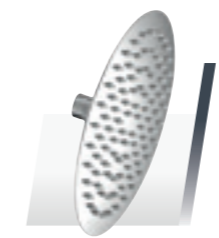

ROCIADOR SLIM 2 mm
ACERO INOX Ø20 mm

AISI 304 Stainless Steel Slim Sprayer
Pulvérisateur mince en acier inoxydable
Pulverizador no em aço inoxidável



MANGO 3 POSICIONES
Shower Handle 3 positions
Poignée 3 positions
Chuveiro 3 posições



LATÓN BRASS **BARRA LATÓN REGULABLE EN ALTURA**
Adjustable height brass bar
Barre en laiton réglable en hauteur
Barra de latão ajustável em altura



LOW SOUND **SOPORTE DUCHA DESLIZANTE**
Slider shower holder
Support de douche coulissant
Suporte deslizante de chuveiro



INVERSOR CERÁMICO
Ceramic inverter
Onduleur céramique
Inversor cerámico



DETALLES TÉCNICOS EN
Technical details in
Détails techniques
dans
Detalhes técnicos na
P. 181



REF. 68055

MONOMANDO

Columna ducha
MAXI

Single-lever
Mitigeur
Monocomando

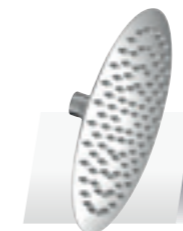

ROCIADOR SLIM 2 mm
ACERO INOX Ø20 mm

AISI 304

Stainless Steel Slim Sprayer
Pulvérisateur mince en acier inoxydable
Pulverizador no em aço inoxidável



MANGO 3 POSICIONES

Shower Handle 3 positions
Poignée 3 positions
Chuveiro 3 posições



LATÓN BRASS

BARRA LATÓN REGULABLE EN ALTURA
Adjustable height brass bar
Barre en laiton réglable en hauteur
Barra de latão ajustável em altura

LOW SOUND

SOPORTE DUCHA DESLIZANTE
Slider shower holder
Support de douche coulissant
Suporte deslizante de chuveiro



INVERSOR CERÁMICO

Ceramic inverter
Onduleur céramique
Inversor cerâmico



Columna
SQ-77

DETALLES TÉCNICOS EN
Technical details in
Détails techniques
dans
Detalhes técnicos na
P. 181

REF. 68077

TERMOSTÁTICA

Columna ducha SQ-77

Thermostatic
Thermostatique
Termostática

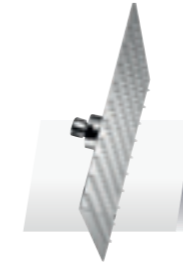

**ROCIADOR SLIM 2 mm
ACERO INOX 200 x 200 mm**

AISI
304

Slim Sprayer Stainless steel
Pulvérisateur mince en acier inoxydable
Pulverizador fino em aço inoxidável

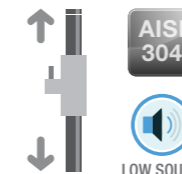

AISI
304

BARRA AISI 304 REGULABLE EN ALTURA
Adjustable height AISI 304 bar
Barre AISI 304 réglable en hauteur
Barra AISI 304 ajustável em altura

LOW SOUND



SOPORTE DUCHA DESLIZANTE

Slider shower holder
Support de douche coulissant
Suporte deslizante de chuveiro



INVERSOR CERÁMICO INTEGRADO EN EL MANDO

Ceramic Inverter built in the handle
Inverseur céramique intégré dans le poignée
Inversor cerâmico integrado no controle



Water is the Future

Griferia



35

DETALLES TÉCNICOS EN
Technical details in
Détails techniques
dans
Detalhes técnicos na
P. 181



REF. 68064

TERMOSTÁTICA

Columna ducha
VULKAN

Thermostatic
Thermostatique
Termostática



ROCIADOR SLIM 2 mm
ACERO INOX Ø20 mm

AISI 304

Stainless Steel Slim Sprayer
Pulvérisateur mince en acier inoxydable
Pulverizador no em aço inoxidável



MANGO 3 POSICIONES

Shower Handle 3 positions
Poignée 3 positions
Pega do chuveiro de 3 posições



AISI 304

BARRA AISI 304 REGULABLE EN ALTURA
Adjustable height AISI 304 bar
Barre AISI 304 réglable en hauteur
Barra AISI 304 ajustável em altura



LOW SOUND

SOPORTE DUCHA DESLIZANTE
Slider shower holder
Support de douche coulissant
Suporte deslizante de chuveiro



INVERSOR CERÁMICO INTEGRADO EN EL MANDO

Ceramic Inverter built in the handle
Inverseur céramique intégré dans le poignée
Inversor cerâmico integrado no controle

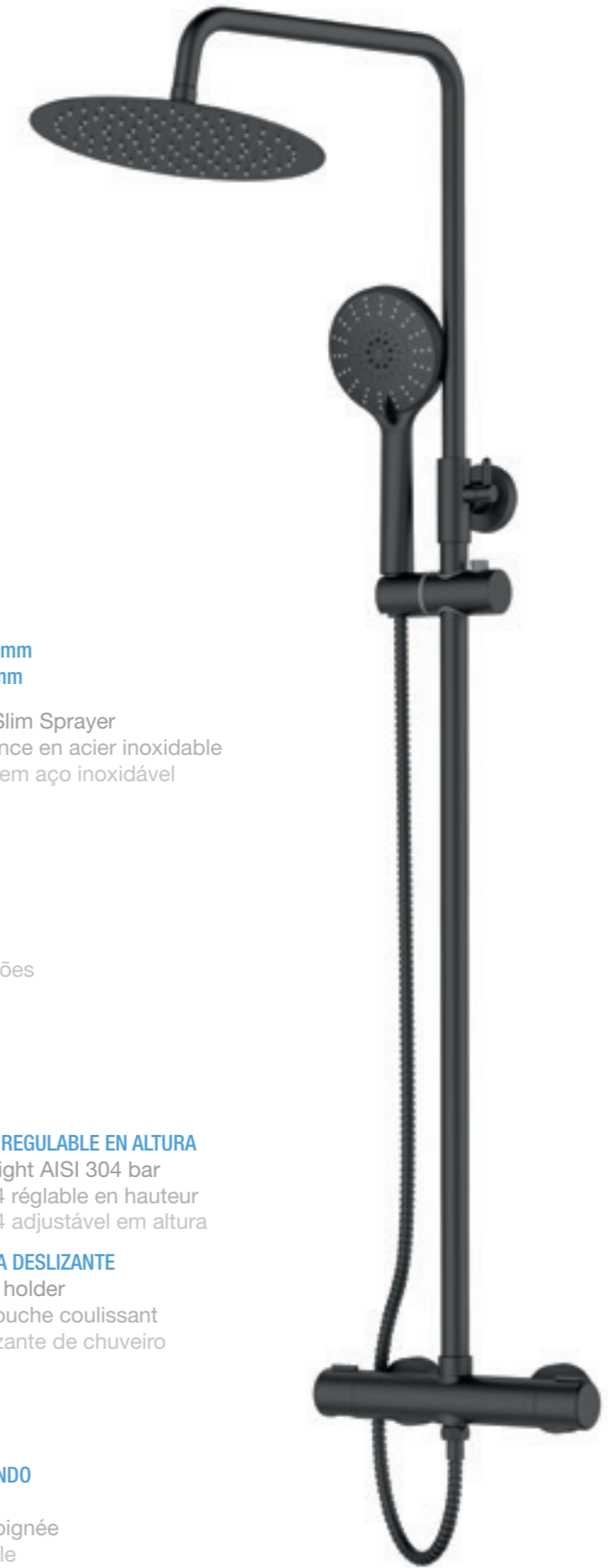

DETALLES TÉCNICOS EN
Technical details in
Détails techniques dans
Detalhes técnicos na
P. 181



INVERSOR CERÁMICO INTEGRADO EN EL MANDO
Ceramic Inverter built in the handle
Inverseur céramique intégré dans le poignée
Inversor cerâmico integrado no controle



LATÓN BRASS
BARRA LATÓN REGULABLE EN ALTURA
Adjustable height brass bar
Barre en laiton réglable en hauteur
Barra de latão ajustável em altura



LOW SOUND
SOPORTE DUCHA DESLIZANTE
Slider shower holder
Support de douche coulissant
Suporte deslizante de chuveiro



MANGO 3 POSICIONES
Shower Handle 3 positions
Poignée 3 positions
Chuveiro 3 posições

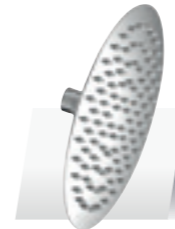

ROCIADOR SLIM 2 mm
ACERO INOX Ø20 mm



AISI 304
Stainless Steel Slim Sprayer
Pulvérisateur mince en acier inoxydable
Pulverizador no em aço inoxidável



REF. 68057
TERMOSTÁTICA

Columna ducha
MAXI-2

Thermostatic
Thermostatique
Termostática



Safe Stop



DETALLES TÉCNICOS EN
Technical details in
Détails techniques
dans
Detalhes técnicos na
P. 181



REF. 68025

BIMANDO

Columna ducha
STILO

Two-handle
Deux poignées
Duas alças

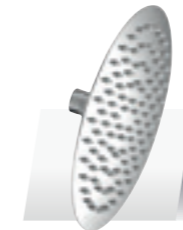

ROCIADOR SLIM 2 mm
ACERO INOX Ø20 mm

Stainless Steel Slim Sprayer
Pulvérisateur mince en acier inoxydable
Pulverizador no em aço inoxidável



AISI 304



LATÓN BRASS

BARRA LATÓN REGULABLE EN ALTURA
Adjustable height brass bar
Barre en laiton réglable en hauteur
Barra de latão ajustável em altura



LOW SOUND



SOPORTE DUCHA DESLIZANTE

Slider shower holder
Support de douche coulissant
Suporte deslizante de chuveiro



INVERSOR CERÁMICO

Ceramic inverter
Onduleur céramique
Inversor cerâmico



SLINE

by Mirtak



De consumo en agua
Water consumption

Incluido con la opción SLINE
Included with SLINE option

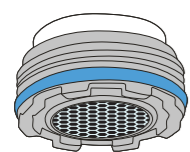

ATOMIZADOR
WATER AERATOR

Compatible con lavabos,
fregaderas y bidets
Compatible with wash-basin,
sink and bidets mixers

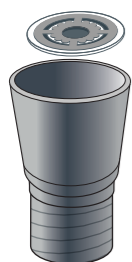

REDUCTOR FLEJO
HOSE REDUCTOR

Compatible con duchas
y baños
Compatible with shower
and bath mixers

CONSUMO
CONSUMPTION

6-8 l/min*

*Pruebas de presión a 3 bar / *Pression test at 3 bar

SERIES CON OPCIÓN A SLINE
SERIES WITH SLINE OPTION



SVELTA



SVELTA
BLACK



VEGA



YUKON



TENNA



MAIA



MAIA
BLACK

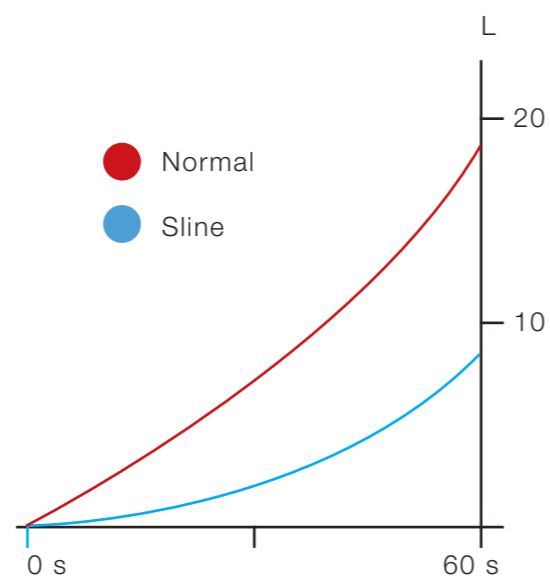

Serie **SVELTA**

MINIMALISMO ESTILIZADO

Proporciones perfectas, líneas refinadas
y figura aparente.

STYLIZED MINIMALISM

Perfect proportions, refined lines
and apparent figure.





MONOMANDO BAÑO
Single lever bath mixer
Mitigeur Baignoire
Monocomando Banho

REF. 68183
REF. 68183-Sline 



MONOMANDO DUCHA
Single lever shower mixer
Mitigeur Douche
Monocomando Duche

REF. 68184
REF. 68184-Sline 



MONOMANDO LAVABO
Single lever wash-basin mixer
Mitigeur lavabo
Monocomando Lavatório

REF. 68181
REF. 68181-Sline 



MONOMANDO LAVABO ALTO
High single lever wash-basin mixer
Mitigeur lavabo haut
Monocomando Lavatório Alto

REF. 68186
REF. 68186-Sline 



MONOMANDO BIDÉ
Single lever bidet mixer
Mitigeur Bidet
Monocomando Bidé

REF. 68182
REF. 68182-Sline 



MONOMANDO FREGADERA
Single lever sink mixer
Mitigeur évier
Monocomando Cozinha

REF. 68185
REF. 68185-Sline 



DETALLES TÉCNICOS EN

Technical details in
Détails techniques dans
Detalhes técnicos na
P. 182

Serie **SVELTA BLACK**

MINIMALISMO DE CONTRASTES

Elegancia con contraste, proporciones perfectas, líneas refinadas y figura aparente.

CONTRAST MINIMALISM

Elegance with contrast, perfect proportions, refined lines and an apparent figure.





MONOMANDO BAÑO
Single lever bath mixer
Mitigeur Baignoire
Monocomando Banho

REF. 68193
REF. 68193-Sline



MONOMANDO DUCHA
Single lever shower mixer
Mitigeur Douche
Monocomando Duche

REF. 68194
REF. 68194-Sline



MONOMANDO LAVABO
Single lever wash-basin mixer
Mitigeur lavabo
Monocomando Lavatório

REF. 68191
REF. 68191-Sline



MONOMANDO LAVABO ALTO
High single lever wash-basin mixer
Mitigeur lavabo haut
Monocomando Lavatório Alto

REF. 68196
REF. 68196-Sline



MONOMANDO BIDÉ
Single lever bidet mixer
Mitigeur Bidet
Monocomando Bidé

REF. 68192
REF. 68192-Sline



MONOMANDO FREGADERA
Single lever sink mixer
Mitigeur évier
Monocomando Cozinha

REF. 68195
REF. 68195-Sline

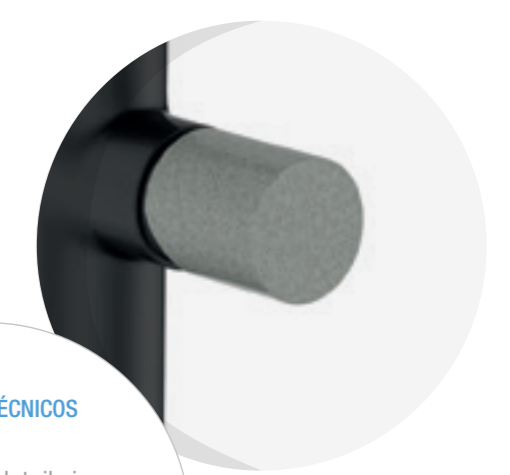

DETALLES TÉCNICOS EN
Technical details in
Détails techniques dans
Detalhes técnicos na
P. 182-183

Serie —
VEGA

PROPORCIÓN SELECTA

El ser selecto, da la capacidad de atraer las formas de mayor estilismo y juntarlas en una misma figura, para crear, una línea perfectamente refinada.

SELECT PROPORTIONS

Being select, gives the ability to attract the most stylish forms and join them in the same figure, to create a perfectly refined line.





MONOMANDO LAVABO
Single lever wash-basin mixer
Mitigeur lavabo
Monocomando Lavatório

REF. 68131

REF. 68131-Sline  -50%



MONOMANDO LAVABO ALTO
High single lever wash-basin mixer
Mitigeur lavabo haut
Monocomando Lavatório Alto

REF. 68136

REF. 68136-Sline  -50%



MONOMANDO BIDÉ
Single lever bidet mixer
Mitigeur Bidet
Monocomando Bidé

REF. 68132

REF. 68132-Sline  -50%

DETALLES TÉCNICOS EN

Technical details in

Détails techniques dans

Detalhes técnicos na

P. 183-184



MONOMANDO BAÑO
Single lever bath mixer
Mitigeur Baignoire
Monocomando Banho

REF. 68133

REF. 68133-Sline  -50%



MONOMANDO DUCHA
Single lever shower mixer
Mitigeur Douche
Monocomando Duche

REF. 68134

REF. 68134-Sline  -50%



MONOMANDO FREGADERA BLACK
Black Single lever sink mixer
Mitigeur évier noir
Monocomando Cozinha preto

REF. 68125

REF. 68125-Sline  -50%



MONOMANDO FREGADERA CROMO
Chrome Single lever sink mixer
Mitigeur évier chrome
Monocomando Cozinha cromada

REF. 68135

REF. 68135-Sline  -50%

Serie **YUKON**

FIGURA ARMONIOSA

Curvas de proporciones áureas, de cuerpo robusto e índice cromado en su parte posterior, transmiten, una perfecta armonía.

HARMONIOUS FIGURE

Curves of golden proportions, with a robust body and a hidden chrome index, to convey, perfect harmony





Inversor cerámico 1/4 de vuelta
Ceramic inverter 1/4 turn



MONOMANDO BAÑO
Single lever bath mixer
Mitigeur Baignoire
Monocomando Banho

REF. 68163
REF. 68163-Sline 



MONOMANDO DUCHA
Single lever shower mixer
Mitigeur Douche
Monocomando Duche

REF. 68164
REF. 68164-Sline 



MONOMANDO LAVABO
Single lever wash-basin mixer
Mitigeur lavabo
Monocomando Lavatório

REF. 68161
REF. 68161-Sline 



MONOMANDO BIDÉ
Single lever bidet mixer
Mitigeur Bidet
Monocomando Bidé

REF. 68162
REF. 68162-Sline 



DETALLES TÉCNICOS EN

Technical details in
Détails techniques dans
Detalhes técnicos na
P. 184

Serie **TENNA**

UNIÓN CON CARÁCTER

Líneas mayormente rectas, entrelazadas armoniosamente con las suaves curvas del cuerpo, otorgando, estilo y elegancia en el conjunto.

UNION WITH CHARACTER

Mostly straight lines, harmoniously intertwined with the smooth curves of the body, giving style and elegance in the whole





DETALLES TÉCNICOS EN

Technical details in
 Détails techniques dans
 Detalhes técnicos na
P. 185



MONOMANDO BAÑO
 Single lever bath mixer
 Mitigeur Baignoire
 Monocomando Banho

REF. 68093
 REF. 68093-Sline 



MONOMANDO DUCHA
 Single lever shower mixer
 Mitigeur Douche
 Monocomando Duche

REF. 68094
 REF. 68094-Sline 



MONOMANDO LAVABO
 Single lever wash-basin mixer
 Mitigeur lavabo
 Monocomando Lavatório

REF. 68091
 REF. 68091-Sline 



MONOMANDO BIDÉ
 Single lever bidet mixer
 Mitigeur Bidet
 Monocomando Bidé

REF. 68092
 REF. 68092-Sline 



MONOMANDO FREGADERA CROMO
 Chrome Single lever sink mixer
 Mitigeur évier chrome
 Monocomando Cozinha cromada

REF. 68095
 REF. 68095-Sline 



MONOMANDO FREGADERA BLACK
 Black Single lever sink mixer
 Mitigeur évier noir
 Monocomando Cozinha preto

REF. 68096
 REF. 68096-Sline 

Serie —
MAIA

CURVAS OJIVALES

De formas planas, redondeadas y de cavidades abiertas para dar un estilo propio y único en su conjunto.

POINTED CURVES

Flat and rounded shapes with open cavities, that give a unique and own style as a whole.





MONOMANDO BAÑO
Single lever bath mixer
Mitigeur Baignoire
Monocomando Banho

REF. 68143

REF. 68143-Sline 



MONOMANDO DUCHA
Single lever shower mixer
Mitigeur Douche
Monocomando Duche

REF. 68144

REF. 68144-Sline 



MONOMANDO LAVABO
Single lever wash-basin mixer
Mitigeur lavabo
Monocomando Lavatório

REF. 68141

REF. 68141-Sline 



MONOMANDO LAVABO ALTO
High single lever wash-basin mixer
Mitigeur lavabo haut
Monocomando Lavatório Alto

REF. 68146

REF. 68146-Sline 



MONOMANDO BIDÉ
Single lever bidet mixer
Mitigeur Bidet
Monocomando Bidé

REF. 68142

REF. 68142-Sline 



MONOMANDO FREGADERA
Single lever sink mixer
Mitigeur évier
Monocomando Cozinha

REF. 68145

REF. 68145-Sline 



DETALLES TÉCNICOS EN

Technical details in
Détails techniques dans

Detalhes técnicos na
P. 185-186

Serie **MAIA BLACK**

CURVAS CON CONTRASTE

Lineas estilizadas, de formas planas, redondeadas y de cavidades abiertas con su contraste propio en color negro.

CONTRAST CURVES

Stylized lines, flat and rounded shape with open cavities, that give a unique and own dark contrast.





MONOMANDO BAÑO
 Single lever bath mixer
 Mitigeur Baignoire
 Monocomando Banho

REF. 68153
 REF. 68153-Sline



MONOMANDO DUCHA
 Single lever shower mixer
 Mitigeur Douche
 Monocomando Duche

REF. 68154
 REF. 68154-Sline



MONOMANDO LAVABO
 Single lever wash-basin mixer
 Mitigeur lavabo
 Monocomando Lavatório

REF. 68151
 REF. 68151-Sline



MONOMANDO LAVABO ALTO
 High single lever wash-basin mixer
 Mitigeur lavabo haut
 Monocomando Lavatório Alto

REF. 68156
 REF. 68156-Sline



MONOMANDO BIDÉ
 Single lever bidet mixer
 Mitigeur Bidet
 Monocomando Bidé

REF. 68152
 REF. 68152-Sline



MONOMANDO FREGADERA
 Single lever sink mixer
 Mitigeur évier
 Monocomando Cozinha

REF. 68155
 REF. 68155-Sline



DETALLES TÉCNICOS EN
 Technical details in
 Détails techniques dans
 Detalhes técnicos na
P. 186-187

essence

by **Mirtak**

“Conjunto de características permanentes e invariables que determinan a un ser o una cosa y sin las cuales no sería lo que es.”

“Set of permanent and invariable characteristics that determine a being or a thing and without which it would not be what it is.”

SERIES DE LA LÍNEA ESSENCE SERIES ON THE ESSENCE LINE



Serie 
BEST



SIEMPRE ACTUAL

De cortes rectos que dan singularidad y un toque distintivo.

Actual y provocadora, son los rasgos que mejor la definen.

ALWAYS UP TO DATE

Straight shapes that give singularity and a distinctive design.

Current and provocative, are the traits that best define it.



essence
by Mirtak



MONOMANDO BAÑO
 Single lever bath mixer
 Mitigeur Baignoire
 Monocomando Banho

REF. 68033



MONOMANDO DUCHA
 Single lever shower mixer
 Mitigeur Douche
 Monocomando Duche

REF. 68034



MONOMANDO LAVABO
 Single lever wash-basin mixer
 Mitigeur lavabo
 Monocomando Lavatório

REF. 68031



MONOMANDO BIDÉ
 Single lever bidet mixer
 Mitigeur Bidet
 Monocomando Bidé

REF. 68032



MONOMANDO FREGADERA (CAÑO FUNDIDO)
 Single lever sink mixer (cast spout)
 Mitigeur évier (bec fondu)
 Monocomando Cozinha (bico fundido)

REF. 68036



DETALLES TÉCNICOS EN

Technical details in
 Détails techniques dans

Detalhes técnicos na
P. 187

Serie **CENTURY**



ELEGANCIA EN SUS LÍNEAS

Composición elegante y seductora de formas curvas, inspiradas en la belleza del agua al fluir.

ELEGANCE IN ITS LINES

Elegant and seductive composition made of curved shapes, inspired by the beauty of the water flowing.



essence
by **Mirtak**



MONOMANDO BAÑO
Single lever bath mixer
Mitigeur Baignoire
Monocomando Banho

REF. 68053



MONOMANDO DUCHA
Single lever shower mixer
Mitigeur Douche
Monocomando Duche

REF. 68054



MONOMANDO LAVABO
Single lever wash-basin mixer
Mitigeur lavabo
Monocomando Lavatório

REF. 68051



MONOMANDO BIDÉ
Single lever bidet mixer
Mitigeur Bidet
Monocomando Bidé

REF. 68052



**DETALLES TÉCNICOS
EN**

Technical details in

Détails techniques
dans

Detalhes técnicos na

P. 188

Serie **STILO**



ROMANTICISMO ACTUAL

Evocando al pasado con su funcionamiento bimando, junto a las manetas rectas y cilíndricas, estilizan el conjunto y aportan un aire romántico a esta colección.

ACTUAL ROMANTICISM

Its two handles system evokes the past, together with the straight and cylindrical shapes, stylize the whole and brings a romantic nuance to this collection.



essence
by Mirtak



BIMANDO LAVABO
Two handle wash-basin faucet
Robinet lavabo
Torneira Lavatório

REF. 68021



BIMANDO BIDÉ
Two handle bidet faucet
Robinet Bidet
Torneira Bidé

REF. 68022



BIMANDO BAÑO
Two handle bath faucet
Robinet Baignoire
Torneira Banho

REF. 68023



BIMANDO DUCHA
Two handle shower faucet
Robinet Douche
Torneira Duche

REF. 68024



BIMANDO FREGADERA
Two handle sink faucet
Robinet évier
Torneira Cozinha

REF. 68026



DETALLES TÉCNICOS EN

Technical details in
Détails techniques dans

Detalhes técnicos na
P. 188-189

Serie 
NEVA

ROBUSTEZ ELEVADA

Su robustez interior se representa en líneas redondeadas y rectas que marcan una apariencia suave, con matices cálidos y de silueta refinada en su conjunto.

HIGH ROBUSTNESS

Its inner robustness is represented in rounded and straight lines, that mark a soft appearance, with warm aspects and refined silhouette as a whole.



essence
by Mirtak



MONOMANDO LAVABO
Single lever wash-basin mixer
Mitigeur lavabo
Monocomando Lavatório

REF. 68171



MONOMANDO BIDÉ
Single lever bidet mixer
Mitigeur Bidet
Monocomando Bidé

REF. 68172



MONOMANDO BAÑO
Single lever bath mixer
Mitigeur Baignoire
Monocomando Banho

REF. 68173



MONOMANDO DUCHA
Single lever shower mixer
Mitigeur Douche
Monocomando Duche

REF. 68174



MONOMANDO FREGADERA
Single lever sink mixer
Mitigeur évier
Monocomando Cozinha

REF. 68175



DETALLES TÉCNICOS EN

Technical details in
Détails techniques dans

Detalhes técnicos na
P. 189

Serie 
NAVY

FUSIÓN CON CARÁCTER

La sincronía de líneas rectas y curvas dan personalidad a esta colección, en su cuerpo residen las curvas, mientras que su parte superior estiliza esta série.

MERGED CHARACTER

The synchronicity of straight lines and curves give personality to this collection, while in the lower part of the body reside the curves, the top part stylize this series.



essence
by Mirtak



MONOMANDO LAVABO
 Single lever wash-basin mixer
 Mitigeur lavabo
 Monocomando Lavatório

REF. 68081



MONOMANDO BAÑO
 Single lever bath mixer
 Mitigeur Baignoire
 Monocomando Banho

REF. 68083



MONOMANDO DUCHA
 Single lever shower mixer
 Mitigeur Douche
 Monocomando Duche

REF. 68084



MONOMANDO BIDÉ
 Single lever bidet mixer
 Mitigeur Bidet
 Monocomando Bidé

REF. 68082



MONOMANDO FREGADERA
 Single lever sink mixer
 Mitigeur évier
 Monocomando Cozinha

REF. 68085



DETALLES TÉCNICOS EN

Technical details in
 Détails techniques dans

Detalhes técnicos na
P. 189-190

Serie 
OASIS

DISEÑO ATEMPORAL

La belleza de lo sutil es permanente, una colección para siempre, con sus líneas semi-curvas otorgan suavidad en su figura.

TIMELESS DESIGN

The beauty of the subtle is permanent, a timeless collection with its semi-curved and soft lines, giving softness on its figure.



essence
by **Mirtak**



DETALLES TÉCNICOS EN

Technical details in
Détails techniques dans
Detalhes técnicos na
P. 190-192



MONOMANDO LAVABO
Single lever wash-basin mixer
Mitigeur lavabo
Monocomando Lavatório

REF. 68011



MONOMANDO BIDÉ
Single lever bidet mixer
Mitigeur Bidet
Monocomando Bidé

REF. 68012



MONOMANDO BAÑO
Single lever bath mixer
Mitigeur Baignoire
Monocomando Banho

REF. 68013



MONOMANDO DUCHA
Single lever shower mixer
Mitigeur Douche
Monocomando Duche

REF. 68014



MONOMANDO FREGADERA VERTICAL
Vertical Single lever sink mixer
Mitigeur évier vertical
Monocomando Cozinha vertical

REF. 68016



MONOMANDO FREGADERA VERTICAL (CAÑO FUNDIDO)
Vertical Single lever sink mixer (cast spout)
Mitigeur évier vertical (bec fondu)
Monocomando Cozinha vertical (bico fundido)

REF. 65802



MONOMANDO FREGADERA VERTICAL BLANCO
 White vertical Single lever sink mixer
 Mitigeur évier vertical blanc
 Monocomando Cozinha vertical Branco

REF. 65801



MONOMANDO FREGADERA VERTICAL TIERRA FRANCIA
 Terre France vertical Single lever sink mixer
 Mitigeur évier vertical Terre France
 Monocomando Cozinha vertical Terre France

REF. 65807



MONOMANDO FREGADERA EXTRAÍBLE HORIZONTAL
 Horizontal Removable single lever sink mixer
 Mitigeur évier horizontal extractable
 Monocomando Cozinha horizontal removível

REF. 65805



MONOMANDO FREGADERA PARED
 Wall Single lever sink mixer
 Mitigeur évier mural corp
 Monocomando Cozinha parede corpo

REF. 65815
 15 cm cuerpo / body / corp / corpo
 65816
 11 cm cuerpo / body / corp / corpo



MONOMANDO FREGADERA "ECO" VERTICAL
 Vertical "ECO" Single lever sink mixer
 Mitigeur évier "ECO" vertical
 Monocomando Cozinha "ECO" vertical

REF. 65817



MONOMANDO FREGADERA HORIZONTAL
 Horizontal Single lever sink mixer
 Mitigeur évier horizontal
 Monocomando Cozinha horizontal

REF. 68017



MONOMANDO FREGADERA EXTRAÍBLE VERTICAL
 Vertical Removable single lever sink mixer
 Mitigeur évier vertical extractable
 Monocomando Cozinha vertical removível

REF. 65806



MONOMANDO FREGADERA PARED (CAÑO FUNDIDO)
 Wall Single lever sink mixer (cast spout)
 Mitigeur évier mural (bec fondu)
 Monocomando Cozinha parede (bico fundido)

REF. 68018

DETALLES TÉCNICOS EN

Technical details in
 Détails techniques dans

Detalhes técnicos na

P. 190-192

Serie **MEDICAL**

CONFORT ATEMPORAL

En torno a la comodidad nace esta colección, incorporando rasgos suaves y sutiles donde la practicidad prevalece haciéndola ideal para espacios de uso público.

TIMELESS COMFORT

This collection was born around comfort, incorporating soft and subtle features where practicality prevails, making it ideal for public spaces.



essence
by **Mirtak**



MONOMANDO LAVABO

Single lever wash-basin mixer
Mitigeur lavabo
Monocomando Lavatório

REF. 14052



MONOMANDO FREGADERA PARED (CAÑO BAJO)

Wall Single lever sink mixer (low spout)
Mitigeur évier mural (bec bas)
Monocomando Cozinha parede (bico baixo)

REF. 14054



MONOMANDO DUCHA

Single lever shower mixer
Mitigeur Douche
Monocomando Duche

REF. 14055



MONOMANDO FREGADERA HORIZONTAL

Horizontal Single lever sink mixer
Mitigeur évier horizontal
Monocomando Cozinha horizontal

REF. 14053



GRIFO FRONTAL LARGO 1/2

Long Front tap 1/2
Long Robinet frontal 1/2
Torneira longa frontal 1/2

REF. 14051

DETALLES TÉCNICOS EN

Technical details in

Détails techniques dans

Detalhes técnicos na

P. 192

GRIFERÍA
COCINA
KITCHEN
MIXERS



Fregaderas **SLINE**
 CON OPCIÓN SUSTAINABLE OPTION



De consumo en agua
 Water consumption



F8 MONOMANDO FREGADERA EXTRAÍBLE FLEXIBLE
 Removable flexible single lever sink mixer
 Mitigeur évier extractable flexible
 Monocomando cozinha flexível removível

REF. 65808

REF. 65808-Sline

DETALLES TÉCNICOS EN
 Technical details in
 Détails techniques dans
 Detalhes técnicos na
 P. 192-193



VEGA MONOMANDO FREGADERA NEGRO
 Black Single lever sink mixer
 Mitigeur évier noir
 Monocomando Cozinha preto

REF. 68125

REF. 68125-Sline



VEGA MONOMANDO FREGADERA CROMO
 Chrome Single lever sink mixer
 Mitigeur évier chrome
 Monocomando Cozinha cromada

REF. 68135

REF. 68135-Sline



TENNA MONOMANDO FREGADERA CROMO
 Chrome Single lever sink mixer
 Mitigeur évier chrome
 Monocomando Cozinha cromada

REF. 68095

REF. 68095-Sline



TENNA MONOMANDO FREGADERA BLACK
 Black Single lever sink mixer
 Mitigeur évier noir
 Monocomando Cozinha preto

REF. 68096

REF. 68096-Sline



MAIA MONOMANDO FREGADERA
 Single lever sink mixer
 Mitigeur évier
 Monocomando Cozinha

REF. 68145

REF. 68145-Sline



MAIA BLACK MONOMANDO FREGADERA NEGRO
 Black single lever sink mixer
 Mitigeur évier noir
 Monocomando Cozinha preto

REF. 68155

REF. 68155-Sline

Fregaderas OSMOSIS

DETALLES TÉCNICOS EN

Technical details in
Détails techniques
dans
Detalhes técnicos na
P. 193-194



Fregaderas EXTRAÍBLES

DETALLES TÉCNICOS EN

Technical details in
Détails techniques
dans
Detalhes técnicos na
P. 194

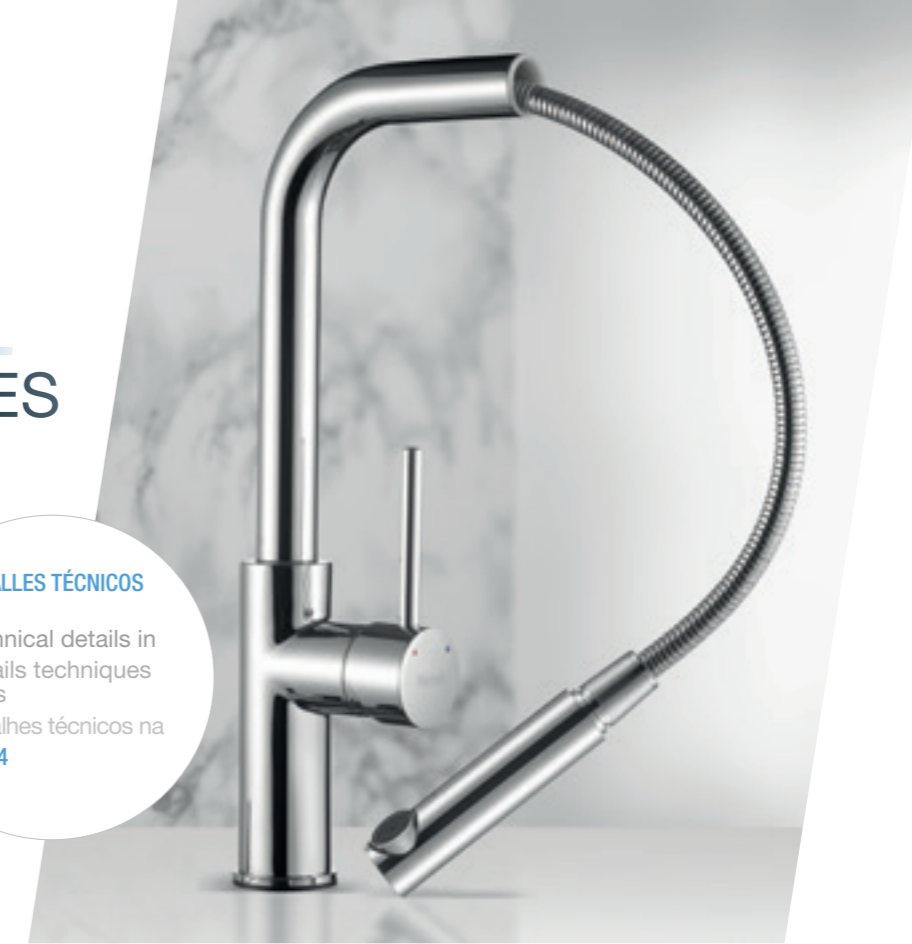

F14 MONOMANDO FREGADERA OSMOSIS (1 MANETA)
Osmosis single lever sink mixer (1 handle)
Mitigeur évier Osmosis (1 poignée)
Monocomando cozinha Osmosis (1 alça)

REF. 65814



F13 MONOMANDO FREGADERA OSMOSIS CENTURY (2 MANETAS)
Osmosis single lever sink mixer (2 handles)
Mitigeur évier Osmosis (2 poignées)
Monocomando cozinha Osmosis (2 alças)

REF. 65813



F20 MONOMANDO FREGADERA EXTRAÍBLE
Removable single lever sink mixer
Mitigeur évier extractable
Monocomando cozinha flexível

REF. 65820



OASIS MONOMANDO FREGADERA EXTRAÍBLE HORIZONTAL
Horizontal removable single lever sink mixer
Mitigeur évier horizontal extractable
Monocomando cozinha horizontal removível

REF. 65805



OASIS MONOMANDO FREGADERA EXTRAÍBLE VERTICAL
Vertical removable single lever sink mixer
Mitigeur évier vertical extractable
Monocomando cozinha vertical removível

REF. 65806

Fregaderas
FLEXIBLES

DETALLES TÉCNICOS EN
 Technical details in
 Détails techniques dans
 Detalhes técnicos na
P. 194-195



Griferia
COCINA



F9 MONOMANDO FREGADERA CON MUELLE EXTRAÍBLE
 Single lever sink mixer with removable spring
 Mitigeur évier avec ressort extractable
 Monocomando cozinha com mola removível

REF. 65809



F18 MONOMANDO FREGADERA FLEXIBLE NEGRO
 Flexible black single lever sink mixer
 Mitigeur évier flexible noir
 Monocomando cozinha flexível preta

REF. 65818



F19 MONOMANDO FREGADERA FLEXIBLE BLANCO
 Flexible white single lever sink mixer
 Mitigeur évier flexible blanc
 Monocomando cozinha flexível branco

REF. 65819



F21 MONOMANDO FREGADERA FLEXIBLE AZUL
 Flexible blue single lever sink mixer
 Mitigeur évier flexible bleu
 Monocomando cozinha flexível azul

REF. 65821



F22 MONOMANDO FREGADERA FLEXIBLE GRIS
 Flexible grey single lever sink mixer
 Mitigeur évier flexible gris
 Monocomando cozinha flexível cinzento

REF. 65822

Fregaderas
LÍNEA LINE
ESSENCE

DETALLES TÉCNICOS EN
Technical details in
Détails techniques dans
Detalhes técnicos na
P. 195-197



STILO BIMANDO FREGADERA
Two handle sink faucet
Robinet évier
Torneira cozinha

REF. 68026



NEVA MONOMANDO FREGADERA
Single lever sink mixer
Mitigeur évier
Monocomando cozinha

REF. 68175



CENTURY ABATIBLE MONOMANDO FREGADERA
Folding single lever sink mixer
Mitigeur évier pliant
Monocomando cozinha dobrando

REF. 65812



BEST MONOMANDO FREGADERA (CAÑO FUNDIDO)
Single lever sink mixer (cast spout)
Mitigeur évier (bec fondu)
Monocomando cozinha (bico fundido)

REF. 68036



CENTURY MONOMANDO FREGADERA CURVO
Single lever sink mixer
Mitigeur évier
Monocomando cozinha

REF. 68050



NAVY MONOMANDO FREGADERA
Single lever sink mixer
Mitigeur évier
Monocomando cozinha

REF. 68085



OASIS MONOMANDO FREGADERA VERTICAL
Vertical Single lever sink mixer
Mitigeur évier vertical
Monocomando cozinha vertical

REF. 68016



OASIS MONOMANDO FREGADERA VERTICAL (CAÑO FUNDIDO)
 Vertical Single lever sink mixer (cast spout)
 Mitigeur évier vertical (bec fondu)
 Monocomando cozinha vertical (bico fundido)

REF. 65802



OASIS MONOMANDO FREGADERA VERTICAL BLANCO
 White vertical Single lever sink mixer
 Mitigeur évier Blanc
 Monocomando cozinha vertical Branco

REF. 65801



OASIS MONOMANDO FREGADERA HORIZONTAL
 Horizontal Single lever sink mixer
 Mitigeur évier horizontal
 Monocomando cozinha horizontal

REF. 68017



MEDICAL MONOMANDO FREGADERA HORIZONTAL
 Horizontal Single lever sink mixer
 Mitigeur évier horizontal
 Monocomando cozinha horizontal

REF. 14053



OASIS MONOMANDO FREGADERA VERTICAL TIERRA FRANCIA
 Terre France vertical Single lever sink mixer
 Mitigeur évier vertical Terre France
 Monocomando cozinha vertical Terre France

REF. 65807



OASIS MONOMANDO FREGADERA "ECO" VERTICAL
 Vertical "ECO" Single lever sink mixer
 Mitigeur évier "ECO" vertical
 Monocomando cozinha "ECO" vertical

REF. 65817



OASIS MONOMANDO FREGADERA PARED
 Wall Single lever sink mixer
 Mitigeur évier mural
 Monocomando cozinha parede

REF. 65815
 15 cm cuerpo / body / corp / corpo
 65816
 11 cm cuerpo / body / corp / corpo



OASIS MONOMANDO FREGADERA PARED (CAÑO FUNDIDO)
 Wall Single lever sink mixer (cast spout)
 Mitigeur évier mural (bec fondu)
 Monocomando cozinha parede (bico fundido)

REF. 68018



MEDICAL MONOMANDO FREGADERA PARED (CAÑO BAJO)
 Wall Single lever sink mixer (low spout)
 Mitigeur évier mural (bec bas)
 Monocomando cozinha parede (bico baixo)

REF. 14054

Fregaderas
BASIC



DETALLES TÉCNICOS EN
Technical details in
Détails techniques dans
Detalhes técnicos na
P. 197



BATERIA FREGADERA CAÑO VERTICAL
Wall sink mixer vertical spout
Robinet évier bec vertical
Torneira cozinha bico vertical

REF. **65905**
11 cm cuerpo / body / corp / corpo

REF. **65904**
15 cm cuerpo / body / corp / corpo



GRIFO FREGADERA GIRATORIO CAÑO HORIZONTAL
Wall sink tap horizontal spout (1 track)
Robinet évier mural bec horizontal (1 voie)
Torneira cozinha parede bico vertical (1 via)

REF. **65902**



BATERIA FREGADERA CAÑO HORIZONTAL
Wall sink mixer horizontal spout
Robinet évier bec horizontal
Torneira cozinha bico horizontal

REF. **65901**
11 cm cuerpo / body / corp / corpo
22 cm caño / spout / bec / bico

REF. **65900**
11 cm cuerpo / body / corp / corpo
18 cm caño / spout / bec / bico

REF. **65903**
15 cm cuerpo / body / corp / corpo
22 cm caño / spout / bec / bico

REF. **65907**
15 cm cuerpo / body / corp / corpo
18 cm caño / spout / bec / bico



GRIFO FREGADERA GIRATORIO CAÑO VERTICAL
Wall sink tap vertical spout (1 track)
Robinet évier mural bec vertical (1 voie)
Torneira cozinha parede bico horizontal (1 via)

REF. **65906**



GRIFO MONOBLOC FREGADERA CAÑO VERTICAL
Sink tap vertical spout (1 track)
Robinet évier bec vertical (1 voie)
Torneira cozinha bico vertical (1 via)

REF. **65910**

GRIFERÍA
TERMOSTÁTICA
THERMOSTATIC
MIXERS





DETALLES TÉCNICOS EN
 Technical details in
 Détails techniques dans
 Detalhes técnicos na
P. 197-198



TERMOSTÁTICA DUCHA STANDARD
 Thermostatic shower mixer
 Robinet de douche thermostatique
 Torneira termostática para chuveiro

REF. 68040



TERMOSTÁTICA DUCHA SQUARE
 Thermostatic shower mixer
 Robinet de douche thermostatique
 Torneira termostática para chuveiro

REF. 68044



TERMOSTÁTICA BAÑO STANDARD
 Thermostatic bath mixer
 Robinet thermostatique pour baignoire
 Torneira termostática para banho

REF. 68041

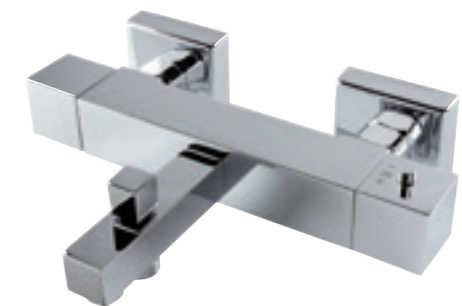

TERMOSTÁTICA BAÑO SQUARE
 Thermostatic bath mixer
 Robinet thermostatique pour baignoire
 Torneira termostática para banho

REF. 68045

GRIFERÍA
ELECTRÓNICA
ELECTRONIC
MIXERS





ERGO GRIFO ELECTRÓNICO LAVABO
Electronic wash-basin tap
Robinet lavabo électronique
Torneira lavatório eletrônica

REF. 14026
1 agua / track / voie / via

REF. 14025
2 aguas / tracks / voies / vias



STAR SQUARE GRIFO ELECTRÓNICO LAVABO
Electronic wash-basin tap
Robinet lavabo électronique
Torneira lavatório eletrônica

REF. 14028
1 agua / track / voie / via

REF. 14027
2 aguas / tracks / voies / vias



STAR SQUARE GRIFO EMPOTRADO ELECTRÓNICO
Built-in electronic wash-basin tap
Robinet encastré mural électronique
Torneira lavatório embutida eletrônica

REF. 14018
1 agua / track / voie / via

REF. 14017
2 aguas / tracks / voies / vias

DETALLES TÉCNICOS EN
Technical details in
Détails techniques dans
Detalhes técnicos na
P. 198-199



ERGO GRIFO ELECTRÓNICO LAVABO ALTO
High electronic wash-basin tap
Robinet lavabo électronique haut
Torneira lavatório eletrônica alto

REF. 14024
1 agua / track / voie / via

REF. 14023
2 aguas / tracks / voies / vias



STAR ROUND GRIFO ELECTRÓNICO LAVABO
Electronic wash-basin tap
Robinet lavabo électronique
Torneira lavatório eletrônica

REF. 14034
1 agua / track / voie / via

REF. 14029
2 aguas / tracks / voies / vias



STAR ROUND GRIFO EMPOTRADO ELECTRÓNICO LAVABO
Built-in electronic wash-basin tap
Robinet encastré mural électronique
Torneira lavatório embutida eletrônica

REF. 14016
1 agua / track / voie / via

REF. 14015
2 aguas / tracks / voies / vias

GRIFERÍA
TEMPORIZADA
Y PEDALES
TIMER TAPS
& PEDALS



TEMPORIZADOS / TIMER TAPS

LAVABO
WASH-BASIN



GRIFO T1 TEMPORIZADO LAVABO
Wash-basin timer tap
Robinet lavabo temporisé
Torneira temporizador lavatório

REF. 14031



GRIFO T2 MEZCLADOR TEMPORIZADO LAVABO
Wash-basin timer mixer
Mitigeur lavabo temporisé
Torneira misturador temporizador lavatório

REF. 14032



GRIFO TEMPORIZADOR LAVABO
Wash-basin timer tap
Robinet lavabo temporisé
Torneira temporizador lavatório

REF. 14030



GRIFO TEMPORIZADO FRONTAL
Wash-basin frontal timer tap
Robinet d'évier temporisé
Torneira temporizador frontal

REF. 14033

TEMPORIZADOS / TIMER TAPS

DUCHA
SHOWER



GRIFO TEMPORIZADO DUCHA EMPOTRAR
Wall-mounted shower timer tap
Robinet encastré douche temporisé
Torneira embutida duche temporizador

REF. 14037



ROCIADOR LATÓN TOMA EMPOTRAR 1/2
Brass shower head
Laiton pomme douche
Lavar a cabeça latão

REF. 59103

URINARIO
URINARY



FLUXOMETRO WC ENTRADA 3/4 SALIDA Ø28
WC timer tap 3/4 - Ø28
Robinet WC temporisé 3/4 - Ø28
Torneira WC temporizador 3/4 - Ø28

REF. 14047

DETALLES TÉCNICOS EN
Technical details in
Détails techniques dans
Detalhes técnicos na
P. 199-200



TEMPORIZADOS / TIMER TAPS

URINARIO
URINARY



GRIFO TEMPORIZADO URINARIO FRONTAL
Wall-mounted urinal timer tap
Robinet d'urinoir temporisé
Torneira temporizador para urinol

REF. 14035



ACCESORIO TEMPORIZADO URINARIO 15,5 CM.
Urinal timer tap accessory
Accessoire robinet d'urinoir temporisé
Acessório torneira urinol temporizador

REF. 14036



GRIFO TEMPORIZADO EMPOTRAR URINARIO
Wall-mounted urinal timer tap
Robinet encastré d'urinoir temporisé
Torneira embutida urinol temporizador

REF. 14038

DETALLES TÉCNICOS EN

Technical details in
Détails techniques dans
Detalhes técnicos na
P. 200

PEDALES / PEDALS



GRIFO PEDAL 1 AGUA ECO
Pedal tap 1 track
Robinet pédale 1 voie
Torneira pedal 1 via

REF. 14041



GRIFO PEDAL 2 AGUAS ECO
Pedal mixer tap
Mitigeur pédale
Torneira misturador pedal

REF. 14048

CAÑOS GIRATORIOS ROTATORY PIPES



CAÑO GIRATORIO VERTICAL INCLINADO
Inclined rotatory pipe
Bec pivotant vertical incliné
Bico giratório vertical inclinado

REF. 14046



GRIFO PIE EMPOTRADO
Foot wall-mounted tap
Robinet au pied encastré
Torneira de pé embutida

REF. 14040

GRIFERÍA EMPOTRADA BUILD-IN MIXERS



DETALLES TÉCNICOS
EN
Technical details in
Détails techniques
dans
Detalhes técnicos na
P. 200-201-202

CUADRADOS / SQUARE

LAVABO
WASH-BASIN



BEST MONOMANDO LAVABO EMPOTRAR
Build-in wash-basin mixer
Mitigeur lavabo encastré mural
Torneira misturador lavatório embutida

REF. 68231



STAR SQUARE
GRIFO EMPOTRADO ELECTRÓNICO
Built-in electronic wash-basin tap
Robinet encastré mural électronique
Torneira lavatório embutida eletrônica

REF. 14018

1 agua / track / voie / via

REF. 14017

2 aguas / tracks / voies / vias

DUCHA
SHOWER



BEST MONOMANDO DUCHA EMPOTRAR 2 VÍAS
Build-in 2 tracks shower mixer
Mitigeur douche encastré 2 voies
Monocomando duche embutida 2 vias

REF. 68233



BEST MONOMANDO DUCHA EMPOTRAR 1 VÍA
Build-in 1 track shower mixer
Mitigeur douche encastré 1 voie
Monocomando duche embutida 1 via

REF. 68234

REDONDOS / ROUND

LAVABO
WASH-BASIN



CENTURY MONOMANDO LAVABO EMPOTRAR
Build-in wash-basin mixer
Mitigeur lavabo encastré mural
Torneira misturador lavatório embutida

REF. 68251



STAR ROUND
GRIFO EMPOTRADO ELECTRÓNICO LAVABO
Built-in electronic wash-basin tap
Robinet encastré mural électronique
Torneira lavatório embutida eletrônica

REF. 14016

1 agua / track / voie / via

REF. 14015

2 aguas / tracks / voies / vias

DUCHA
SHOWER



CENTURY MONOMANDO DUCHA EMPOTRAR 2 VÍAS
Build-in 2 tracks shower mixer
Mitigeur douche encastré 2 voies
Monocomando duche embutida 2 vias

REF. 68253



CENTURY MONOMANDO DUCHA EMPOTRAR 1 VÍA
Build-in 1 track shower mixer
Mitigeur douche encastré 1 voie
Monocomando duche embutida 1 via

REF. 68254

CUADRADOS / SQUARE

SETS BEST



SET 1 BEST

**MONOMANDO EMPOTRADO 2 VÍAS
ROCIADOR SLIM Y BRAZO RECTO
MANGO Y FLEXO**

Build-in 2 tracks mixer
Slim sprayer & straight arm
Shower hand & hose
Mitigeur encastré 2 voies
Spray mince et bras droit
Poignée et flexible
Monocomando embutida
2 vías
Spray fino e braço reto
Chuveiro e mangueira

REF. 68331

SET 2 BEST

**MONOMANDO EMPOTRADO 2 VÍAS
ROCIADOR SLIM Y BRAZO CURVO
MANGO Y FLEXO**

Build-in 2 tracks mixer
Slim sprayer & curved arm
Shower hand & hose
Mitigeur encastré 2 voies
Spray mince et bras droit
Poignée et flexible
Monocomando embutida
2 vías
Spray fino e braço curvado
Chuveiro e mangueira

REF. 68332

SET 3 BEST

**MONOMANDO EMPOTRADO 1 VÍA
MANGO Y FLEXO**

Build-in 1 track mixer
Shower hand & hose
Mitigeur encastré 1 voie
Poignée et flexible
Monocomando embutida
1 vía
Chuveiro e mangueira

REF. 68333

SET 4 BEST

**MONOMANDO EMPOTRADO 1 VÍA
ROCIADOR SLIM Y BRAZO CURVO
MANGO Y FLEXO**

Build-in 1 track mixer
Slim sprayer & curved arm
Mitigeur encastré 1 voie
Spray mince et bras droit
Monocomando embutida
1 vía
Spray fino e braço curvado

REF. 68334

REDONDOS / ROUND

SETS CENTURY



SET 1 CENTURY

**MONOMANDO EMPOTRADO 2 VÍAS
ROCIADOR SLIM Y BRAZO RECTO
MANGO Y FLEXO**

Build-in 2 tracks mixer
Slim sprayer & straight arm
Shower hand & hose
Mitigeur encastré 2 voies
Spray mince et bras droit
Poignée et flexible
Monocomando embutida
2 vías
Spray fino e braço reto
Chuveiro e mangueira

REF. 68351

SET 2 CENTURY

**MONOMANDO EMPOTRADO 2 VÍAS
ROCIADOR SLIM Y BRAZO CURVO
MANGO Y FLEXO**

Build-in 2 tracks mixer
Slim sprayer & curved arm
Shower hand & hose
Mitigeur encastré 2 voies
Spray mince et bras droit
Poignée et flexible
Monocomando embutida
2 vías. Spray fino e braço
curvado
Chuveiro e mangueira

REF. 68352

SET 3 CENTURY

**MONOMANDO EMPOTRADO 1 VÍA
MANGO Y FLEXO**

Build-in 1 track mixer
Shower hand & hose
Mitigeur encastré 1 voie
Poignée et flexible
Monocomando embutida
1 vía
Chuveiro e mangueira

REF. 68353

SET 4 CENTURY

**MONOMANDO EMPOTRADO 1 VÍA
ROCIADOR SLIM Y BRAZO CURVO
MANGO Y FLEXO**

Build-in 1 track mixer
Slim sprayer & curved arm
Mitigeur encastré 1 voie
Spray mince et bras droit
Monocomando embutida
1 vía
Spray fino e braço curvado

REF. 68354

COMPLEMENTOS DUCHA SHOWER ACCESSORIES

DETALLES TÉCNICOS
EN
Technical details in
Détails techniques
dans
Detalhes técnicos na
P. 202-204



CUADRADO / SQUARE

ROCIADORES Y BRAZOS SHOWER HEADS & ARMS



ROCIADOR CUADRADO SLIM 20 CM

Slim shower head
Pomme douche
Lavar a cabeça

AISI
304

REF. CA-59136



ROCIADOR CUADRADO SLIM 30 CM

Slim shower head
Pomme douche
Lavar a cabeça

AISI
304

REF. CA-59137



BRAZO DUCHA TECHO CUADRADO

Square ceiling shower arm
Bras douche carré au plafond
Braço chuveiro teto quadrado

REF. 59005
1/2 x 20 cm



BRAZO DUCHA PARED CUADRADO

Square wall shower arm
Bras douche mural carré
Braço de chuveiro parede quadrado

REF. 59007
1/2 x 45 cm

REDONDOS / ROUND

ROCIADORES Y BRAZOS SHOWER HEADS & ARMS



ROCIADOR REDONDO SLIM Ø20 CM

Slim shower head
Pomme douche
Lavar a cabeça

AISI
304

REF. CA-59146



ROCIADOR REDONDO SLIM Ø30 CM

Slim shower head
Pomme douche
Lavar a cabeça

AISI
304

REF. CA-59148



BRAZO DUCHA TECHO REDONDO

Round ceiling shower arm
Bras douche rond au plafond
Braço chuveiro teto redondo

REF. 59004
1/2 x 20 cm



BRAZO DUCHA PARED REDONDO

Round wall shower arm
Bras douche mural rond
Braço chuveiro parede quadrado

REF. 59006
1/2 x 45 cm

SETS BARRA
SET BAR



SET BARRA DUCHA LUXURY
Shower bar set
Set barre douche
Conjunto barra de chuveiro

REF. **CA-18113**
Ø28 x 600 mm



SET BARRA DUCHA BANI BLACK
Shower bar set
Set barre douche
Conjunto barra de chuveiro

REF. **CA-18114**
Ø22 x 550 mm (centros) 650 mm (extremos)

CONJUNTOS DUCHA
SHOWER SETS



MANGO DUCHA OMEGA
Handshower
Douchette
Chuveiro

REF. **B-50212**
Ø10 cm

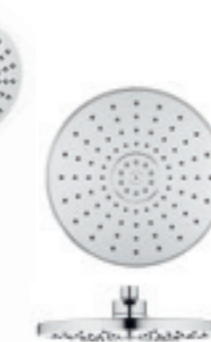

ROCIADOR DUCHA OMEGA
Shower head
Pomme douche
Lavar a cabeça

REF. **CA-59154**
Ø22 cm



MANGO DUCHA BEA
Handshower
Douchette
Chuveiro

REF. **B-50802**
Ø12 cm



ROCIADOR DUCHA BEA
Shower head
Pomme douche
Lavar a cabeça

REF. **CA-59155**
Ø22 cm



MANGO DUCHA NYA
Handshower
Douchette
Chuveiro

REF. **B-50632**
Ø12 cm

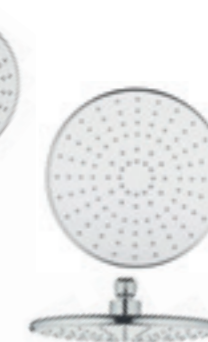

ROCIADOR DUCHA NYA
Shower head
Pomme douche
Lavar a cabeça

REF. **CA-59151**
Ø22 cm



MANGO DUCHA ARAL
Handshower
Douchette
Chuveiro

REF. **B-50642**
12 x 14 cm



ROCIADOR DUCHA ARAL
Shower head
Pomme douche
Lavar a cabeça

REF. **CA-59152**
22 x 25 cm



MANGO DUCHA BANI BLACK
Handshower
Douchette
Chuveiro

REF. **B-50672**
Ø12 cm



ROCIADOR BANI BLACK
Shower head
Pomme douche
Lavar a cabeça

REF. **CA-59156**
Ø20 cm



MANGO DUCHA EYRE
Handshower
Douchette
Chuveiro

REF. **B-50622**
Ø10 cm



ROCIADOR DUCHA EYRE
Shower head
Pomme douche
Lavar a cabeça

REF. **CA-59153**
Ø22 cm

BARRAS
BARS



BARRA DUCHA LATÓN MILENIUM ROUND

Brass shower bar
Barre douche laiton
Barra chuveiro latão

REF. CA-58030
570 mm (centros)
650 mm (extremos)



BARRA DUCHA BANI BLACK

Shower bar
Barre douche
Barra chuveiro

REF. CA-58041
550 mm (centros)
650 mm (extremos)



BARRA DUCHA (SOPORTES LATÓN) DINHA

Shower bar
Barre douche
Barra chuveiro

REF. CA-58014
750 mm



BARRA DUCHA REGULABLE FLORA

Adjustable shower bar
Barre douche dimmable
Barra chuveiro regulável

REF. CA-58016
800 mm

SOPORTES
HOLDERS



SOPORTE DUCHA S-3 CROMO

Shower holder
Support douche
Suporte chuveiro

REF. B-57565



SOPORTE DUCHA S-3 BLACK

Shower holder
Support douche
Suporte chuveiro

REF. B-57566



SOPORTE DUCHA MILENIUM TUBI

Shower holder
Support douche
Suporte chuveiro

REF. B-57583

FLEXOS
HOSES



1,75 m



FLEXO ACERO INOX ANTITORSIÓN

Anti-twist SS shower hose
Tuyau douche inox anti-torsion
Mangueira chuveiro inox anti-torção

REF. B-55033

1,75 m



FLEXO PVC LUX PLATA

PVC shower hose
Tuyau douche PVC
Mangueira chuveiro PVC

REF. B-54203

1,75 m



FLEXO ACERO INOX BLACK

SS shower hose
Flexible douche inox
Mangueira chuveiro inox

REF. B-55123



1,75 m



FLEXO ACERO INOX ESPIRAL MUELLE

SS shower hose
Flexible douche inox
Mangueira chuveiro inox

REF. B-55014

2 m



FLEXO ACERO INOX 2M

SS shower hose
Flexible douche inox
Mangueira chuveiro inox

REF. B-55104

1,75 m
2,20 m
EXTENSIBLE



FLEXO ACERO INOX EXTENSIBLE

Extendable SS shower hose
Flexible douche inox extensible
Mangueira chuveiro extensível

REF. B-55163

**CESTAS
BASKETS**



CESTA COLGAR GRIFERÍA ALUMINIO
Basket to hang on taps
Panier à accrocher aux robinets
Cesta pendurar nas torneiras
REF. CA-62598



CESTA COLGAR GRIFERIA BLACK
Basket to hang on taps
Panier à accrocher aux robinets
Cesta pendurar nas torneiras
REF. CA-62599



CESTA RECTANGULAR ALUMINIO
Rectangular basket
Panier rectangulaire
Cesta rectangular
REF. CA-62597
30 cm
REF. CA-62596
40 cm



CESTA RECTANGULAR BLACK
Rectangular basket
Panier rectangulaire
Cesta rectangular
REF. CA-62589



CESTA TRIANGULAR ALUMINIO
Triangle aluminium basket
Panier triangulaire aluminium
Cesta triangular aluminio
REF. CA-62595



CESTA TRIANGULAR ACERO INOX
Triangle Stainless Steel basket
Panier triangulaire laiton inox
Cesta triangular latão inox
REF. CA-62591



CESTA OVALADA ACERO INOX
Oval Stainless Steel basket
Panier ovale inox
Cesta oval inox
REF. CA-62593

**ASAS
HANDLES**



ASA RECTA LATÓN Ø25
Straight handle
Poignée droite
Puxador reto
REF. CA-62571
25 cm
REF. CA-62573
30 cm
REF. CA-62567
40 cm
REF. CA-62568
50 cm
REF. CA-62569
60 cm



ASA RECTA LATÓN BLANCA Ø25
Straight handle
Poignée droite
Puxador reto
REF. CA-62577
25 cm
REF. CA-62578
30 cm



ASA RECTA LATÓN MATE Ø25
Straight handle
Poignée droite
Puxador reto
REF. CA-62572
30 cm



ASA RECTA LATÓN BRONCE Ø25
Straight handle
Poignée droite
Puxador reto
REF. CA-62570
30 cm



ASA ANTIDESLIZANTE ACERO INOX
Non-slip handle
Poignée antidérapante
Alça antiderrapante
REF. CA-62574
30 cm



BARRA APOYO ACERO INOX BRILLO Ø32
Gloss support bar
Barre de support brillant
Barra de suporte brilho
REF. 14001
30 cm
REF. 14003
50 cm



BARRA APOYO ACERO INOX SATINADA Ø32
Satin support bar
Barre de support satin
Barra de suporte cetim
REF. 14002
30 cm
REF. 14004
50 cm

SISTEMAS HIDROSANITARIOS HIDROSANITARY SYSTEM

DETALLES TÉCNICOS
EN
Technical details in
Détails techniques
dans
Detalhes técnicos na
P. 204-205



VÁLVULAS / VALVES



**VÁLVULA CLIC-CLAC
LATÓN-CROMO**
Brass drain valve
Robinet vidange laiton
Válvula drenagem latão

REF. CA-41518
Ø66 mm
1" 1/4



**VÁLVULA CLIC-CLAC
LATÓN-NEGRO**
Brass drain valve
Robinet vidange laiton
Válvula drenagem latão

REF. CA-41519
Ø66 mm
1" 1/4



**VÁLVULA CLIC-CLAC
LATÓN-PORCELANA**
Brass drain valve
Robinet vidange laiton
Válvula drenagem latão

REF. CA-41517
Ø66 mm
1" 1/4



**VÁLVULA CLIC-CLAC
LATÓN-CROMO**
Brass drain valve
Robinet vidange laiton
Válvula drenagem latão

REF. CA-41526
Ø66 mm
1" 1/4



**VÁLVULA CLIC-CLAC
ABS-CROMO**
ABS drain valve
Robinet vidange ABS
Válvula drenagem ABS

REF. CA-41521
Ø66 mm
1" 1/4



**VÁLVULA CLIC-CLAC
LATÓN-CROMO**
Brass drain valve
Robinet vidange laiton
Válvula drenagem latão

REF. CA-41524
Ø37 mm
1" 1/4



**VÁLVULA CLIC-CLAC
PARTE SUPERIOR**
Brass drain valve
Robinet vidange laiton
Válvula drenagem latão

REF. CA-41528
Ø66 mm
1" 1/4

SIFONES / SIPHONS



SIFÓN LUX / LATÓN-CROMO
Brass drain siphon
Siphon vidange laiton
Sifão drenagem latão

REF. CA-41430
1" 1/4



SIFÓN LUX / LATÓN-NEGRO
Brass drain siphon
Siphon vidange laiton
Sifão drenagem latão

REF. CA-41428
1" 1/4



SIFÓN LUX / LATÓN-BLANCO
Brass drain siphon
Siphon vidange laiton
Sifão drenagem latão

REF. CA-41429
1" 1/4



SIFÓN LUX / ABS-CROMO
ABS drain siphon
Siphon vidange ABS
Sifão drenagem ABS

REF. CA-41435
1" 1/4



SIFÓN BOTELLA CROMADO
Chrome drain siphon
Siphon vidange chromé
Sifão drenagem cromo

REF. CA-41432
1" 1/4

ACCESORIOS
ACCESSORIES





AD
A

DETALLES TÉCNICOS EN
Technical details in
Détails techniques dans
Detalhes técnicos na
P. 205-206

INSTALACIÓN
Installation



Accesorios
DECUA



TOALLERO ANILLA CROMO
Towel Ring
Porte-serviettes Ring
Toalheiro de anel

REF. 30621



PORTARROLLOS CROMO
Paper holder
Porte-rouleau
Porta-rolos

REF. 30622



PERCHA CROMO (2 U.)
Hanger
Cintre
Cabide

REF. 30625



TOALLERO BARRA CROMO 45 CM
Towel rail
Porte-serviettes droit
Toalheiro barra

REF. 30626



AD
A

DETALLES TÉCNICOS EN
Technical details in
Détails techniques dans
Detalhes técnicos na
P. 206

INSTALACIÓN
Installation



Accesorios
DECUA BLACK



TOALLERO ANILLA BLACK
Towel Ring
Porte-serviettes Ring
Toalheiro de anel

REF. 30611

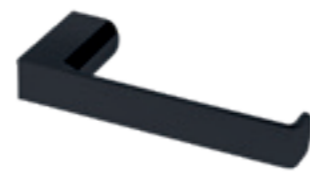

PORTARROLLOS BLACK
Paper holder
Porte-rouleau
Porta-rolos

REF. 30612



PERCHA BLACK (2 U.)
Hanger
Cintre
Cabide

REF. 30615



TOALLERO BARRA BLACK 45 CM
Towel rail
Porte-serviettes droit
Toalheiro barra

REF. 30616

Accesorios
SYN

DETALLES TÉCNICOS EN
Technical details in
Détails techniques dans
Detalhes técnicos na
P. 207

INSTALACIÓN
Installation



PORTARROLLOS CROMO

Paper holder
Porte-rouleau
Porta-rolos

REF. CA-30602



PERCHA CROMO TRIPLE

Triple hanger
Cintre tripler
Cabide triplo

REF. CA-30604



TOALLERO ANILLA CROMO

Towel Ring
Porte-serviettes Ring
Toalheiro de anel

REF. CA-30601



PERCHA CROMO

Hanger
Cintre
Cabide

REF. CA-30605



TOALLERO BARRA CROMO 45 CM

Towel rail
Porte-serviettes droit
Toalheiro barra

REF. CA-30606

Accesorios
VARIOS
VARIED
ACCESSORIES



TOALLERO PARA MUEBLE BAÑO/ COCINA
Towel rack for furniture
Porte-serviettes pour meubles
Toalheiro para móveis

REF. CA-30270
37 cm



AISI
304

ESCOBILLERO CUADRADO ACERO INOX
Toilet brush holder
Porte-brosse
Porta-escova

REF. CA-62580



AISI
304

ESCOBILLERO CILÍNDRICO ACERO INOX
Toilet brush holder
Porte-brosse
Porta-escova

REF. CA-62508



**ESCOBILLERO CÓNICO
BLANCO**
Toilet brush holder
Porte-brosse
Porta-escova

REF. 62506



**ESCOBILLERO CÓNICO
GRIS**
Toilet brush holder
Porte-brosse
Porta-escova

REF. 62507



**ESCOBILLERO CÓNICO
NEGRO**
Toilet brush holder
Porte-brosse
Porta-escova

REF. 62504

Sistemas
CONTACT LESS
SYSTEMS



**DETALLES TÉCNICOS
EN**
Technical details in
Détails techniques
dans
Detalhes técnicos na
P. 208



AISI
304

DOSIFICADOR PIE ACERO INOX CON PEDAL
Stand-up dispenser
Distributeur vertical
Dispensador vertical

REF. CA-62600
1m



DOSIFICADOR DSW1100 ELECTRÓNICO
Electronic dispenser
Distributeur électronique
Dispensador eletrônico

REF. CA-62604
1.100 ml

EXPOSITORES DISPLAYS



**DETALLES TÉCNICOS
EN TARIFA**
Technical details in
price list
Détails techniques
dans les tarifs
Detalhes técnicos
na lista preços

Expositor EXP1

DETALLES TÉCNICOS EN TARIFA

Technical details in price list
Détails techniques dans les tarifs
Detalhes técnicos na lista preços



REF. EXP1-000
200 x 50 cm



REF. EXP1-100
200 x 50 cm



REF. EXP1-150
200 x 50 cm



REF. EXP1-200
200 x 50 cm



REF. EXP1-250
200 x 50 cm



REF. EXP1-300
200 x 50 cm

Expositor
EXP2

PRÓXIMAMENTE
COMING SOON

DETALLES TÉCNICOS
EN TARIFA

Technical details in
price list
Détails techniques
dans les tarifs
Detalhes técnicos
na lista preços

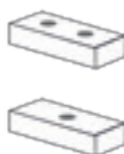

REF. EXP2-000
200 x 50 cm

REF. EXP2-100
200 x 50 cm

REF. EXP2-150
200 x 50 cm

REF. EXP2-200
200 x 50 cm

REF. EXP2-250
200 x 50 cm

REF. EXP2-300
200 x 50 cm

Expositor
EXP3

DETALLES TÉCNICOS
EN TARIFA

Technical details in
price list
Détails techniques
dans les tarifs
Detalhes técnicos
na lista preços

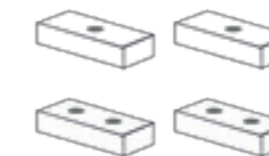
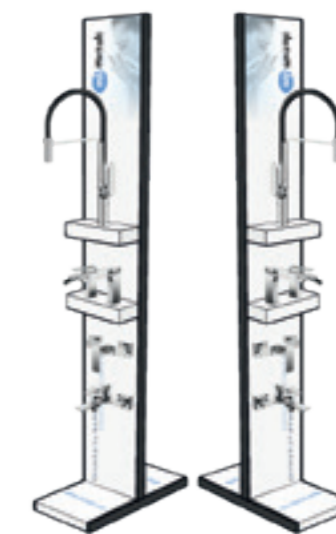
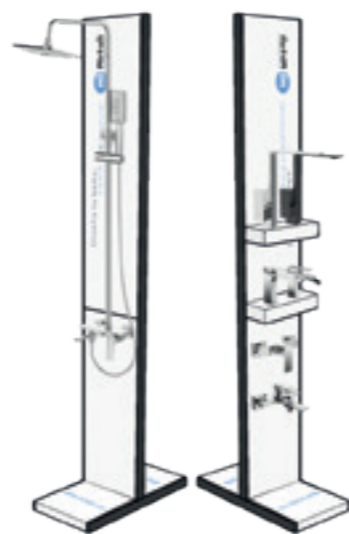
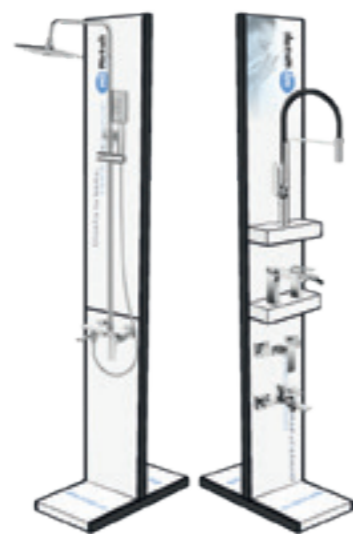

REF. EXP3-000-000
190 x 32 x 65 cm

REF. EXP3-000-150
190 x 32 x 65 cm

REF. EXP3-000-200
190 x 32 x 65 cm

REF. EXP3-000-250
190 x 32 x 65 cm

REF. EXP3-000-300
190 x 32 x 65 cm

REF. EXP3-150-150
190 x 32 x 65 cm

DETALLES TÉCNICOS EN TARIFA
 Technical details in price list
 Détails techniques dans les tarifs
 Detalhes técnicos na lista preços

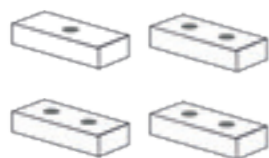

REF. EXP3-150-200
190 x 32 x 65 cm

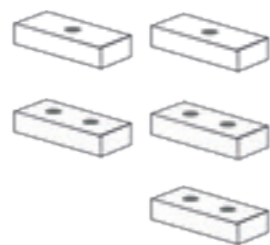

REF. EXP3-150-250
190 x 32 x 65 cm

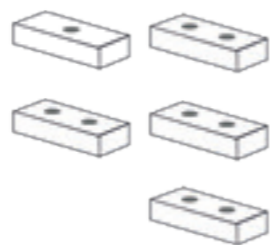

REF. EXP3-150-300
190 x 32 x 65 cm

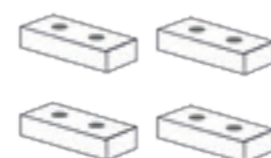
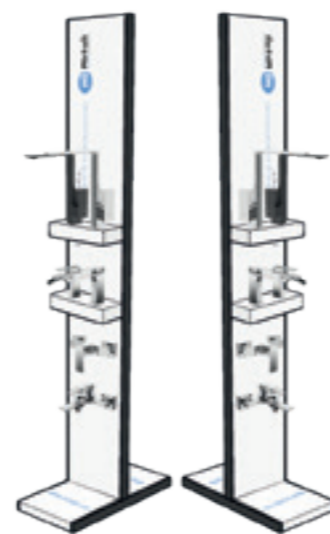

REF. EXP3-200-200
190 x 32 x 65 cm

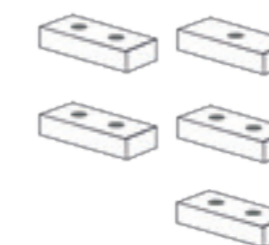

REF. EXP3-200-250
190 x 32 x 65 cm

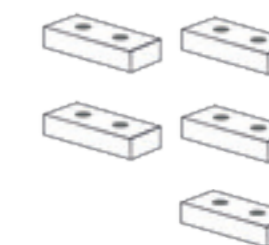

REF. EXP3-200-300
190 x 32 x 65 cm

DETALLES TÉCNICOS EN TARIFA
 Technical details in price list
 Détails techniques dans les tarifs
 Detalhes técnicos na lista preços



REF. EXP3-250-250
190 x 32 x 65 cm

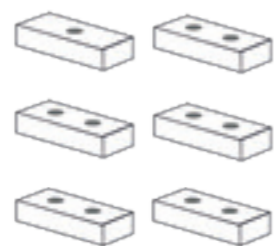

REF. EXP3-250-300
190 x 32 x 65 cm

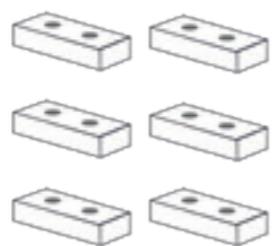

REF. EXP3-300-300
190 x 32 x 65 cm

Expositor EXP4-SLINE

PRÓXIMAMENTE
COMING SOON



DETALLES TÉCNICOS EN TARIFA
 Technical details in price list
 Détails techniques dans les tarifs
 Detalhes técnicos na lista preços

REF. EXP4-SLINE
86 x 140 x 70 cm
13 agujeros /holes

Expositor EXP5



REF. EXP5-000
6 x 30 x 30 cm
2 agujeros /holes

Expositor EXP6

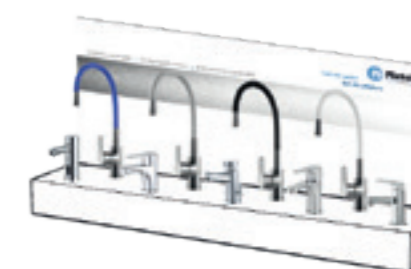

REF. EXP6-000
9 x 100 x 20 cm
9 agujeros /holes

RECAMBIOS GRIFERÍA

MIXER REPLACEMENTS



PALANCAS
HANDLE

0001.039	MANETA SPACE 35 CROMO / Chrome handle / Poignée chromée / Alça cromada
0001.031	MANETA VOLTA BLACK 35 / Black handle / Poignée noire / Aça preto
0001.019	MANETA TENNA 35 CROMO / Chrome handle / Poignée chromée / Alça cromada
0001.014	MANETA QUADRO 35 CROMO / Chrome handle / Poignée chromée / Alça cromada
0001.015	MANETA FENIX 40 / Chrome handle / Poignée chromée / Alça cromada
0001.018	MANETA NAVY 40 / Chrome handle / Poignée chromée / Alça cromada
0001.001	MANETA CENTURY 40 / Chrome handle / Poignée chromée / Alça cromada
0001.035	POMO NEGRO SVELTA 25 / Black knob / Bouton noir / Maçaneta preto
0001.036	POMO GRIS SVELTA BLACK 25 / Grey knob / Bouton / Maçaneta
0001.032	MANETA VEGA 30 CROMO / Chrome handle / Poignée chromée / Alça cromada
0001.033	MANETA VEGA 30 INVERSA CROMO / Chrome handle / Poignée chromée / Alça cromada
0001.034	MANETA VEGA 30 NEGRA / Black handle / Poignée noire / Aça preto
0001.037	MANETA YUKON 40 CROMO / Chrome handle / Poignée chromée / Alça cromada
0001.019	MANETA TENNA 35 CROMO / Chrome handle / Poignée chromée / Alça cromada
0001.020	MANETA TENNA 35 INVERSA CROMO / Chrome handle / Poignée chromée / Alça cromada
0001.038	MANETA TENNA 35 NEGRA / Black handle / Poignée noire / Aça preto
0001.028	MANETA MAIA 25 CROMO / Chrome handle / Poignée chromée / Alça cromada
0001.027	MANETA MAIA 25 INVERSA CROMO / Chrome handle / Poignée chromée / Alça cromada
0001.029	MANETA MAIA BLACK 25 NEGRA / Black handle / Poignée noire / Aça preto
0001.030	MANETA MAIA BLACK 25 NEGRA / Black handle / Poignée noire / Aça preto
0001.016	MANETA BEST 30 CROMO / Chrome handle / Poignée chromée / Alça cromada
0001.040	MANETA BEST 35 EMPOTRADO / Chrome handle / Poignée chromée / Alça cromada
0001.026	MANETA BEST 30 INVERSA CROMO / Chrome handle / Poignée chromée / Alça cromada
0001.017	MANETA CENTURY 35 CROMO / Chrome handle / Poignée chromée / Alça cromada
0001.025	MANETA CENTURY 35 INVERSA CROMO / Chrome handle / Poignée chromée / Alça cromada
0001.023	MANETA NEVA 35 CROMO / Chrome handle / Poignée chromée / Alça cromada
0001.024	MANETA NEVA 35 INVERSA CROMO / Chrome handle / Poignée chromée / Alça cromada
0001.021	MANETA NAVY 35 CROMO / Chrome handle / Poignée chromée / Alça cromada
0001.022	MANETA NAVY 35 INVERSA CROMO / Chrome handle / Poignée chromée / Alça cromada
0001.012	MANETA OASIS 40 CROMO / Chrome handle / Poignée chromée / Alça cromada
0001.011	MANETA OASIS 40 INVERSA CROMO / Chrome handle / Poignée chromée / Alça cromada
0001.010	MANETA OASIS 40 INVERSA BLANCA / White handle / Poignée blanc / Alça branco
0001.009	MANETA OASIS 40 INVERSA TIERRA FRANCIA / Brown handle / Poignée Terre France / Alça castanho
0001.008	MANETA MEDICAL 40 CROMO / Chrome handle / Poignée chromée / Alça cromada
0001.007	MANETA MEDICAL FRONTAL / Chrome handle / Poignée chromée / Alça cromada
0001.006	MANETA F8 INVERSA CROMO / Chrome handle / Poignée chromée / Alça cromada
0001.005	MANETA F14 INVERSA CROMO / Chrome handle / Poignée chromée / Alça cromada
0001.004	MANETA F13 GRANDE INVERSA CROMO / Chrome handle / Poignée chromée / Alça cromada
0001.002	MANETA F9 INVERSA / Chrome handle / Poignée chromée / Alça cromada



VOLANTE
TERMOSTÁTICO
THERMOSTATIC
HANDLE

0001.084	SQ-77 KIT VOLANTES COLUMNNA TERMOSTÁTICA / Handgrip thermostatic kit / kit volant thermostatique / kit volante termostático
0001.085	VULKAN KIT VOLANTES COLUMNNA TERMOSTÁTICA / Handgrip thermostatic kit / kit volant thermostatique / kit volante termostático
0001.081	MAXI-2 KIT VOLANTES COLUMNNA TERMOSTÁTICA / Handgrip thermostatic kit / kit volant thermostatique / kit volante termostático
0001.083	STANDARD KIT VOLANTES TERMOSTÁTICA CROMO / Handgrip thermostatic kit / kit volant thermostatique / kit volante termostático
0001.088	SQUARE KIT VOLANTES TERMOSTÁTICA CROMO / Handgrip thermostatic kit / kit volant thermostatique / kit volante termostático



VOLANTE
BIMANDO
TWO-HANDLE
HANDLE

0001.080	STILO VOLANTE CROMO / Chrome handgrip / Volant chromée / Volante cromada
0001.086	BASIC VOLANTE CROMO ROJO / Chrome-red handgrip / Volant chromée-rouge / Volante cromada-vermelho
0001.087	BASIC VOLANTE CROMO AZUL / Chrome-blue handgrip / Volant chromée-bleu / Volante cromada-azul



CARTUCHO
CARTRIDGE

0001.145	Ø25A CARTUCHO MONOMANDO / Single lever cartridge / Cartouche mitigeur / Cartucho monocomando
0001.144	Ø30A CARTUCHO MONOMANDO / Single lever cartridge / Cartouche mitigeur / Cartucho monocomando
0001.154	Ø35A CARTUCHO MONOMANDO / Single lever cartridge / Cartouche mitigeur / Cartucho monocomando
0001.143	Ø35A DOBLE APERTURA CARTUCHO MONOMANDO / Single lever cartridge / Cartouche mitigeur / Cartucho monocomando
0001.141	Ø35A ECO CARTUCHO MONOMANDO / Single lever cartridge / Cartouche mitigeur / Cartucho monocomando
0001.150	Ø40A CARTUCHO MONOMANDO / Single lever cartridge / Cartouche mitigeur / Cartucho monocomando
0001.142	Ø40A DOBLE APERTURA CARTUCHO MONOMANDO / Single lever cartridge / Cartouche mitigeur / Cartucho monocomando
0001.140	Ø40A ECO CARTUCHO MONOMANDO / Single lever cartridge / Cartouche mitigeur / Cartucho monocomando
0001.148	Ø35B CARTUCHO MONOMANDO / Single lever cartridge / Cartouche mitigeur / Cartucho monocomando
0001.156	Ø18 CARTUCHO TERMOSTÁTICO SQ-77 / Thermostatic cartridge / Cartouche thermostatique / Cartucho termostático
0001.153	Ø30 CARTUCHO TERMOSTÁTICO / Thermostatic cartridge / Cartouche thermostatique / Cartucho termostático
001.155	CARTUCHO TEMPORIZADO EMPOTRADOS / Timer tap cartridge / Cartouche temporisé / Cartucho temporizador
001.157	CARTUCHO TEMPORIZADO T1 & T2 / Timer tap cartridge / Cartouche temporisé / Cartucho temporizador
001.158	CARTUCHO TEMPORIZADO SENCILLO / Timer tap cartridge / Cartouche temporisé / Cartucho temporizador



ATOMIZADOR
INTERNO
INTERNAL
AERATOR

60345	SLINE-M24 + LLAVE / Aerator with key / Aérateur + clé / Aerador + chave
60346	SLINE-M21.5 + LLAVE / Aerator with key / Aérateur + clé / Aerador + chave
60347	SLINE-M18.5 + LLAVE / Aerator with key / Aérateur + clé / Aerador + chave
60348	SLINE-18 (BIDÉ) SOLO REDUCTOR INTERNO / Aerator / Aérateur / Aerador
60342	M24 + LLAVE ORIGINAL / Aerator with key / Aérateur + clé / Aerador + chave
60343	M21.5 + LLAVE ORIGINAL / Aerator with key / Aérateur + clé / Aerador + chave
60344	M18.5 + LLAVE ORIGINAL / Aerator with key / Aérateur + clé / Aerador + chave

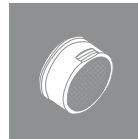

ATOMIZADOR EXTERNO
EXTERNAL AERATOR

60301	M28 X 100 / Aerator / Áérateur / Aerador
60349	H26 X 100 STILO / Aerator / Áérateur / Aerador
60300	M24 X 100 / Aerator / Áérateur / Aerador
60304	M24 X 100 ECO / Aerator / Áérateur / Aerador
60339	H20 X 100 BIDÉ / Aerator / Áérateur / Aerador
60302	H22 X 100 / Aerator / Áérateur / Aerador
60305	H22 X 100 ECO / Aerator / Áérateur / Aerador
60360	LLAVE ATOMIZADORES EXTERNOS / External key / Clé externe / Chave externa
60338	RÓTULA + ATOMIZADOR BIDÉS MAIA, SVELTA, YUKON, VEGA / Chrome ball joint / Rotule chromée / Junta esférica
60337	RÓTULA NEGRA + ATOMIZADOR BIDÉS MAIA Y SVELTA BLACK / Black ball joint / Rotule noir / Junta esférica
60310	RÓTULA NAVY, NEVA, OASIS, BEST, CENTURY, STILO / Chrome ball joint / Rotule chromée / Junta esférica
60337	RÓTULA BIDÉ TENNA / Chrome ball joint / Rotule chromée / Junta esférica
60340	F13 OSMOSIS M18 X 100 / Aerator / Áérateur / Aerador

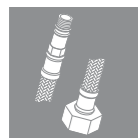

CONEXIONES
HOSES

11931	30 CM NIPEL 7 CM M 9X100 - F 3/8" / Hoses / Connexions / Conexões
11930	35 CM NIPEL 2 CM M 10X100 - F 3/8" / Hoses / Connexions / Conexões
11920	35 CM NIPEL 2 CM M 8X100 - F 3/8" / Hoses / Connexions / Conexões
11940	40 CM NIPEL 2 CM M 10X100 - F 3/8" / Hoses / Connexions / Conexões
11943	40 CM NIPEL 7 CM M 10X100 - F 3/8" / Hoses / Connexions / Conexões
11945	45 CM NIPEL 2 CM M 10X100 - F 3/8" / Hoses / Connexions / Conexões
11915	15 CM M 10X100 - F 15X100 PARA EXTRAÍBLE / Hose / Connexion / Conexõe
11960	60 CM NIPEL 2 CM M 100X10 - F 1/2" / Hose / Connexion / Conexõe



BASE
LOW BASE

0001.230	REDONDA LATÓN CROMO / Brass base / Base laiton / Base latão
0001.231	REDONDA LATÓN NEGRA / Brass base / Base laiton / Base latão
0001.232	CUADRADA LATÓN CROMO / Brass base / Base laiton / Base latão
0001.233	CUADRADA LATÓN NEGRA / Brass base / Base laiton / Base latão



FIJACIÓN
FIXING SYSTEM

0001.240	"EASY FIX" 25
0001.241	"EASY FIX" 30
0001.242	"EASY FIX" 35
0001.243	"EASY FIX" 40
0001.244	JUEGO SUJECIÓN 1 TORNILLO / 1 Screw / 1 Vis / 1 Parafuso
0001.245	JUEGO SUJECIÓN 2 TORNILLOS / 2 Screws / 2 Vis / 2 Parafusos



MONTURAS
HEADWORK

0001.110	VULKAN MONTURA TERMOSTÁTICA / Thermostatic headwork / Monture thermostatique / Monte termostático
0001.109	SQ-77 MONTURA TERMOSTÁTICA / Thermostatic headwork / Monture thermostatique / Monte termostático
0001.108	MAXI-2 MONTURA TERMOSTÁTICA / Thermostatic headwork / Monture thermostatique / Monte termostático
0001.106	STILO MONTURA SERIE Y COLUMNA / Conventional headwork / Monture conventionnel / Monte convencional
0001.105	OSMOSIS F14 PARTE DELANTERA CAÑO / Osmosis headwork / Monture Osmosis / Monte osmosis
0001.101	OSMOSIS F13 MANETA / Osmosis headwork / Monture Osmosis / Monte osmosis
0001.103	BASIC SERIE / Conventional headwork / Monture conventionnel / Monte convencional
0001.100	STANDARD MONTURA TERMOSTÁTICA / Thermostatic headwork / Monture thermostatique / Monte termostático
0001.104	SQUARE MONTURA TERMOSTÁTICA / Thermostatic headwork / Monture thermostatique / Monte termostático



CAÑO
SPOUT

0001.187	22CM CAÑO HORIZONTAL BATERIA / horizontal spout / Bec horizontal / Bico horizontal
0001.185	18CM CAÑO HORIZONTAL BATERIA / horizontal spout / Bec horizontal / Bico horizontal
0001.190	22CM CAÑO VERTICAL BATERIA / Vertical spout / Bec vertical / Bico vertical
0001.188	22CM CAÑO VERTICAL GIRATORIO / vertical spout / Bec vertical / Bico vertical
0001.189	22CM CAÑO HORIZONTAL GIRATORIO / Horizontal spout / Bec horizontal / Bico horizontal
0001.186	SPACE BAÑO COLUMNA DUCHA / Bath spout / Bec baignoire / Bico banho



FLORÓN
PLATE

0001.203	25 CROMO / Chrome / Chrome / Cromada
0001.204	25 NEGRO / Black / Noir / Preto
0001.205	30 CROMO / Chrome / Chrome / Cromada
0001.206	30 NEGRO / Black / Noir / Preto
0001.207	35 CROMO / Chrome / Chrome / Cromada
0001.208	35 NEGRO / Black / Noir / Preto
0001.209	40 CROMO / Chrome / Chrome / Cromada
0001.210	ESPECIAL 40 CROMO / Chrome / Chrome / Cromada
0001.201	FLORON PARED DE 1/2 / Chrome / Chrome / Cromada
0001.211	FLORÓN STILO / Chrome / Chrome / Cromada
0001.212	FLORÓN SQ-77 / Chrome / Chrome / Cromada



EXCÉNTRICAS
ECCENTRIC SET

65702	1/2 X 3/4 X 10 REDONDOS PLANOS CROMO / Round chrome / Rond chrome / Volta cromada
65703	1/2 X 3/4 X 10 REDONDOS PLANOS NEGRO / Round black / Rond Noir / Volta Preto
65704	1/2 X 3/4 X 10 CUADRADOS CROMO / Square chrome / Carrés chrome / Quadrados cromada
65700	1/2 X 3/4 X 10 REDONDOS EMBUDO CROMO / Round chrome / Rond chrome / Volta cromada
65701	1/2 X 3/4 X 20 EXCÉNTRICAS SUPER / Round chrome / Rond chrome / Volta cromada



INVERSORES
DIVERTERS

0001.400	COLUMNA REDONDA CROMO / Shower column / Colonne douche / Coluna chuveiro
0001.401	COLUMNA CUADRADA CROMO / Shower column / Colonne douche / Coluna chuveiro
0001.402	MAIA BAÑO CROMO / Chrome / Chrome / Cromada
0001.403	MAIA BAÑO NEGRO / Black / Noir / Preto
0001.404	VEGA BAÑO CROMO / Chrome / Chrome / Cromada
0001.405	YUKON BAÑO CROMO / Chrome / Chrome / Cromada
0001.406	TENNA BAÑO CROMO / Chrome / Chrome / Cromada
0001.407	BEST BAÑO CROMO / Chrome / Chrome / Cromada
0001.408	CENTURY BAÑO CROMO / Chrome / Chrome / Cromada
0001.409	DISTRIBUIDOR GRUPO BAÑO COMPLETO / Chrome / Chrome / Cromada
0001.410	NEVA BAÑO CROMO / Chrome / Chrome / Cromada
0001.411	NAVY BAÑO CROMO / Chrome / Chrome / Cromada
0001.412	OASIS BAÑO CROMO / Chrome / Chrome / Cromada
0001.413	BEST EMPOTRADO / Chrome / Chrome / Cromada
0001.414	CENTURY EMPOTRADO / Chrome / Chrome / Cromada
0001.415	SQUARE TERMOSTÁTICA BAÑO / Chrome / Chrome / Cromada



MANGO
SHOWER
HANDLE

51302	MANGO DUCHA SPACE / Handshower / Douchette / Chuveiro
50672	MANGO DUCHA BANI BLACK / Handshower / Douchette / Chuveiro
52502	MANGO DUCHA VERO / Handshower / Douchette / Chuveiro
50642	MANGO DUCHA ARAL / Handshower / Douchette / Chuveiro
50522	MANGO DUCHA MILENIUM SQUARE / Handshower / Douchette / Chuveiro
50512	MANGO DUCHA MILENIUM ROUND / Handshower / Douchette / Chuveiro
50202	MANGO DUCHA LI / Handshower / Douchette / Chuveiro
50523	MANGO DUCHA PLANA / Handshower / Douchette / Chuveiro
52202	MANGO DUCHA LOIRA / Handshower / Douchette / Chuveiro
51802	MANGO EXTRAÍBLES OASIS / Handshower / Douchette / Chuveiro
51702	MANGO EXTRAÍBLE F20 / Handshower / Douchette / Chuveiro
51602	MANGO F9 (MUELLE) / Handshower / Douchette / Chuveiro



FLEXO
SHOWER HOSE

55103	ACERO INOX 1.75 M / SS shower hose / Flexible douche inox / Mangueira chuveiro inox
55123	ACERO INOX BLACK 1.75 M / SS Black shower hose / Flexible douche inox noir / Mangueira chuveiro inox preto
56302	ACERO INOX EXTRAÍBLE 1.20 M OASIS / SS sink hose / Flexible inox / Mangueira inox
56304	ACERO INOX EXTRAÍBLE F20 / SS sink hose / Flexible inox / Mangueira inox



REDUCTOR
CAUDAL
WATER
REDUCER

0001.320	7 L/M REDUCTOR CAUDAL SLINE FLEXO / Water reducer / Réducteur d'eau / Redutor de água
0001.321	4 L/MIN REDUCTOR CAUDAL FLEXO / Water reducer / Réducteur d'eau / Redutor de água
60312	REDUCTOR CAUDAL GRUPO BAÑO / Water reducer / Réducteur d'eau / Redutor de água



SOPORTE
DUCHA
SHOWER
HOLDER

0001.421	SOPORTE SPACE / Shower holder / Support douche / Suporte chuveiro
0001.422	SOPORTE COLUMNAS NEGRAS REDONDO / Shower holder / Support douche / Suporte chuveiro
0001.420	SOPORTE COLUMNAS REDONDAS CROMO / Shower holder / Support douche / Suporte chuveiro
0001.423	SOPORTE COLUMNNA QUADRO / Shower holder / Support douche / Suporte chuveiro
0001.424	SOPORTE COLUMNNA SQ-77 / Shower holder / Support douche / Suporte chuveiro
57565	SOPORTE S-3 / Shower holder / Support douche / Suporte chuveiro
57566	SOPORTE S-3 BLACK / Shower holder / Support douche / Suporte chuveiro
57522	SOPORTE COMBI / Shower holder / Support douche / Suporte chuveiro
57583	SOPORTE MILENIUM TUBI / Shower holder / Support douche / Suporte chuveiro

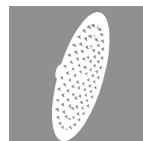

ROCIADOR
SHOWER HEAD

CA-59138	ROCIADOR SPACE / Shower head / Pomme douche / Lavar a cabeça
CA-59149	Ø20 CM SLIM BLACK / Shower head / Pomme douche / Lavar a cabeça
CA-59146	Ø20 CM SLIM REDONDO / Shower head / Pomme douche / Lavar a cabeça
CA-59136	20 CM SLIM CUADRADO / Shower head / Pomme douche / Lavar a cabeça
CA-59152	ROCIADOR ARAL / Shower head / Pomme douche / Lavar a cabeça

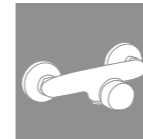

CUERPO
BODY

0001.450	CUERPO COLUMNNA TENNA / Shower column body / Corp colonne douche / Corpo coluna chuveiro
0001.451	CUERPO COLUMNNA CENTURY / Shower column body / Corp colonne douche / Corpo coluna chuveiro
0001.452	CUERPO COLUMNNA QUADRO / Shower column body / Corp colonne douche / Corpo coluna chuveiro
0001.453	CUERPO COLUMNNA NAVY / Shower column body / Corp colonne douche / Corpo coluna chuveiro
0001.454	CUERPO COLUMNNA ARAL / Shower column body / Corp colonne douche / Corpo coluna chuveiro
0001.455	CUERPO COLUMNNA MAXI / Shower column body / Corp colonne douche / Corpo coluna chuveiro
0001.456	CUERPO COLUMNNA MAXI-2 / Shower column body / Corp colonne douche / Corpo coluna chuveiro
0001.457	CUERPO COLUMNNA STILO / Shower column body / Corp colonne douche / Corpo coluna chuveiro

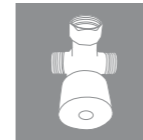

LLAVE
AJUSTE TEMP.
TEMPERATURE
KEY

65852	LLAVE 3 VÍAS 1/2 ELECTRÓNICO / Temperature key / Touche température / Chave temperatura
-------	---

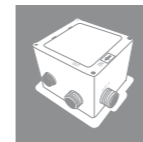

TRANSFORM.
TRANSFORMER

65850	6V. 0 220V STAR TRANSFORMADOR GRIFO ELECTRÓNICO / Transformer / Transformateur / Transformador
65853	6V. ERGO TRANSFORMADOR GRIFO ELECTRÓNICO PILAS / Transformer / Transformateur / Transformador



COLUMNAS
MONOMANDO
SINGLE LEVER
SHOWER
COLUMNS



CM

SPACE BAÑO
REF. 68079

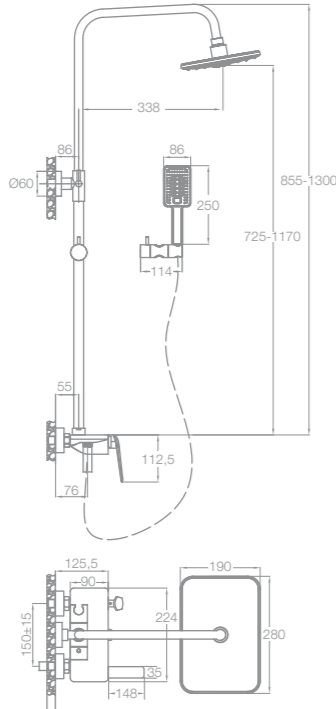

SPACE DUCHA
REF. 68078

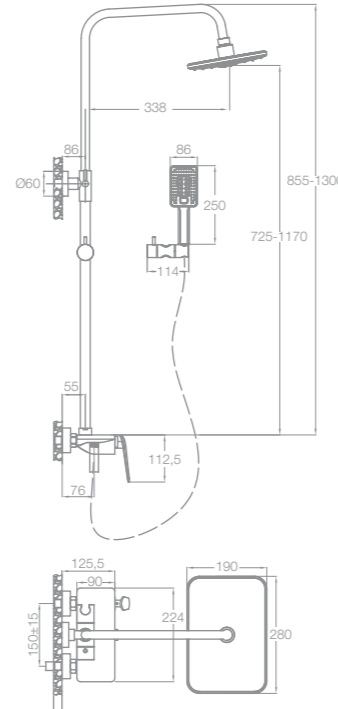

VOLTA BLACK
REF. 68063

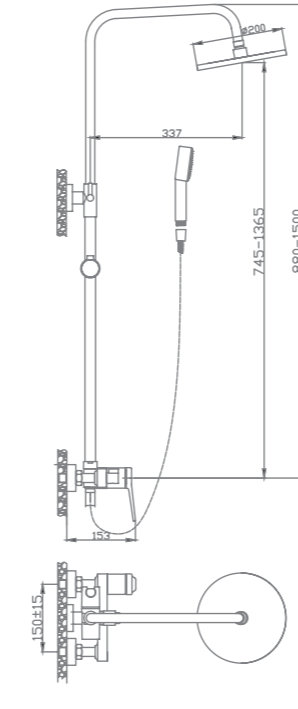

NAVY
REF. 68080

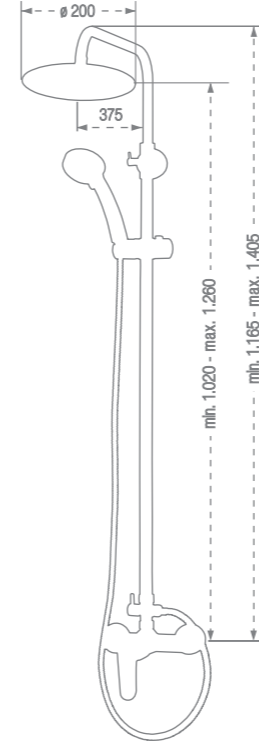

MAXI
REF. 68055

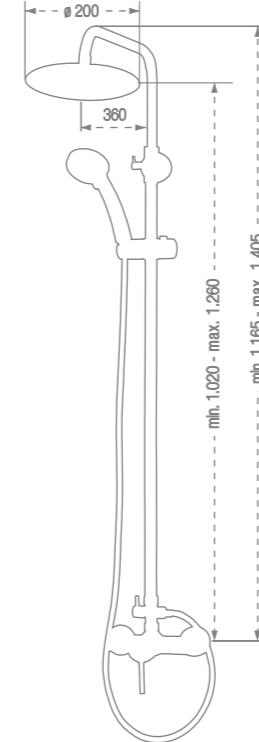

COLUMNAS
BIMANDO
TWO-HANDLE
SHOWER
COLUMNS



CB

STILO
REF. 68025

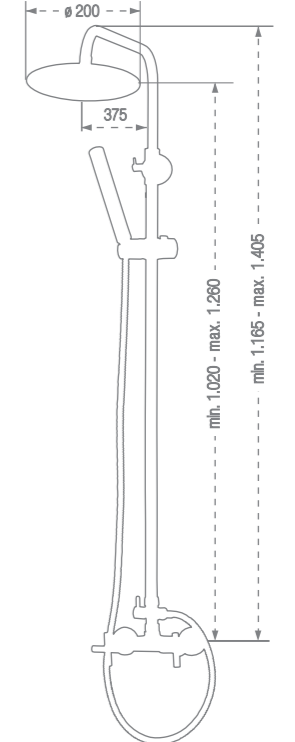

TENNA
REF. 68090

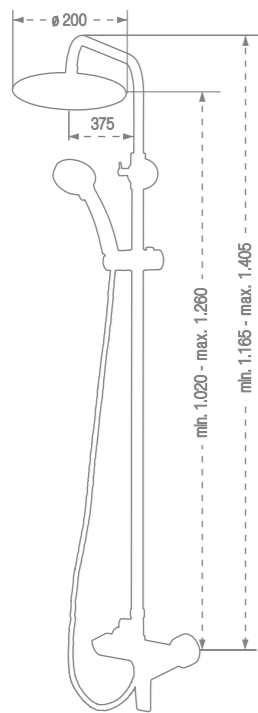

CENTURY
REF. 68048

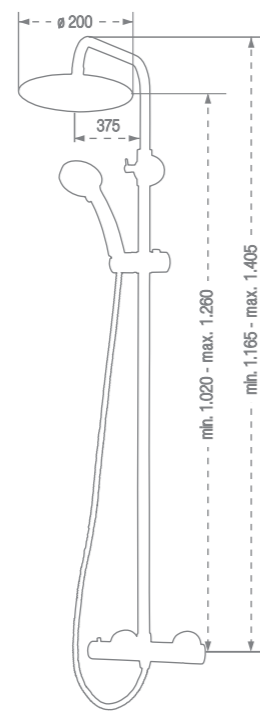

QUADRO
REF. 68076

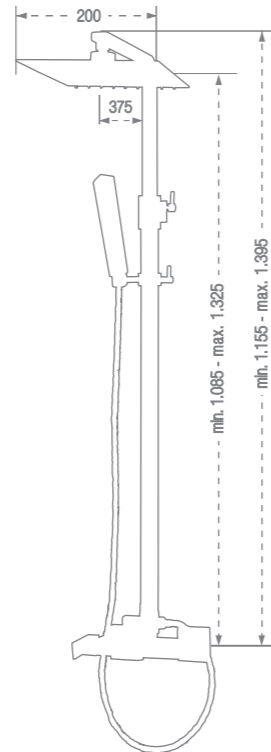

ARAL
REF. 68073

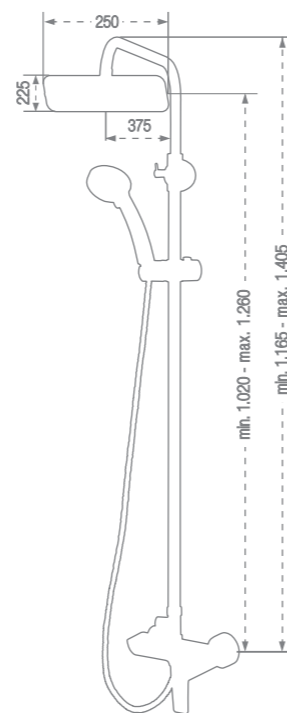

COLUMNAS
TERMOSTÁTICAS
THERMOSTATIC
SHOWER
COLUMNS



CT

SQ-77
REF. 68077

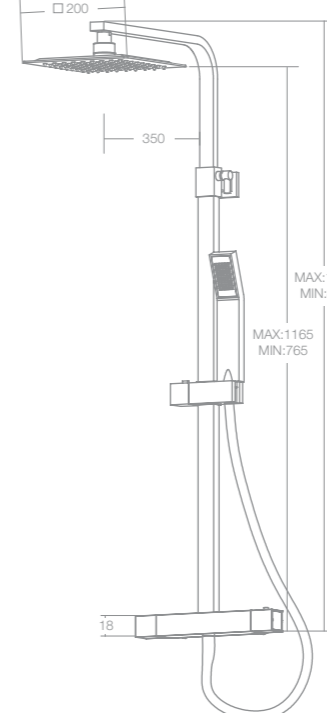

VULKAN
REF. 68064

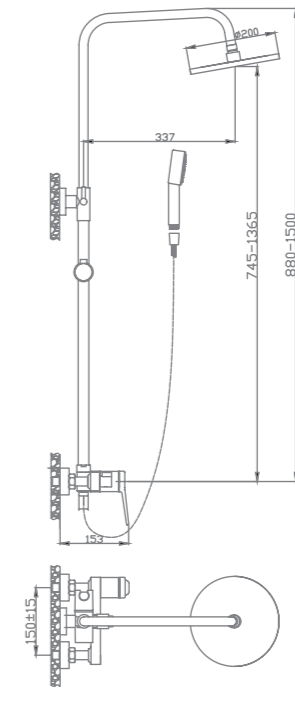

MAXI-2
REF. 68057

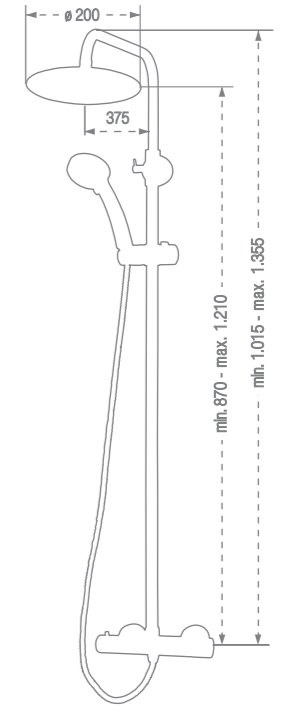



MONOMANDO LAVABO
REF. 68181 / 68181-Sline

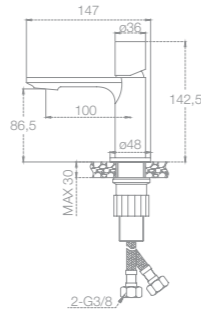

MONOMANDO LAVABO ALTO
REF. 68186 / 68186-Sline

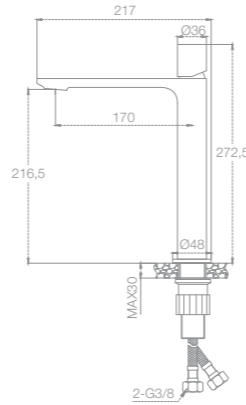

MONOMANDO LAVABO ALTO
REF. 68196 / 68196-Sline

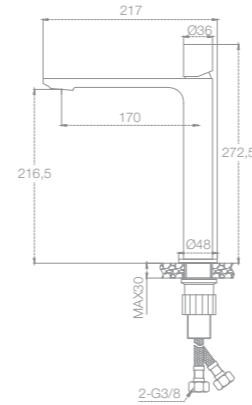

MONOMANDO BIDÉ
REF. 68192 / 68192-Sline

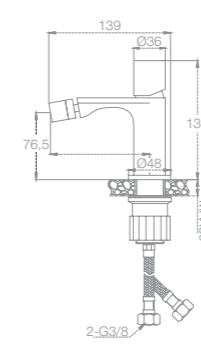

MONOMANDO BAÑO
REF. 68193 / 68193-Sline

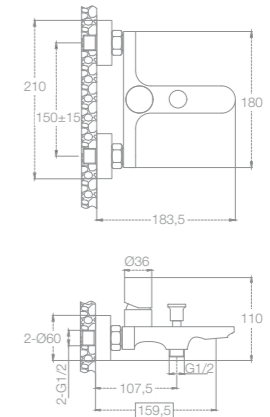

MONOMANDO BIDÉ
REF. 68182 / 68182-Sline

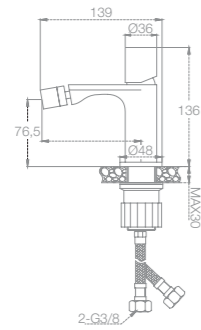

MONOMANDO BAÑO
REF. 68183 / 68183-Sline

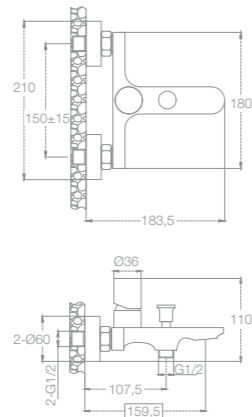

MONOMANDO DUCHA
REF. 68184 / 68184-Sline

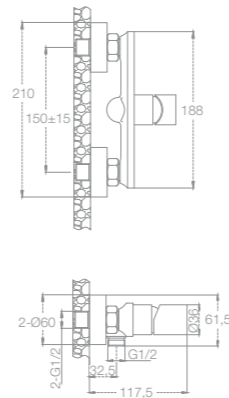

MONOMANDO DUCHA
REF. 68194 / 68194-Sline

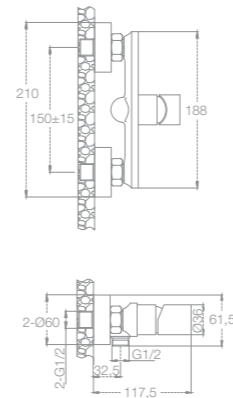

MONOMANDO FREGADERA
REF. 68195 / 68195-Sline

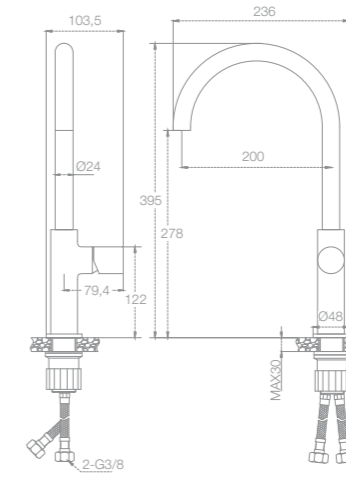

MONOMANDO FREGADERA
REF. 68185 / 68185-Sline

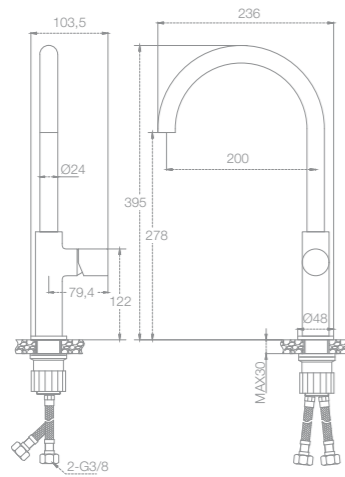

MONOMANDO LAVABO
REF. 68191 / 68191-Sline

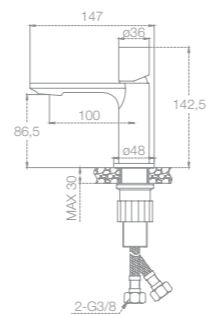

MONOMANDO LAVABO
REF. 68131 / 68131-Sline

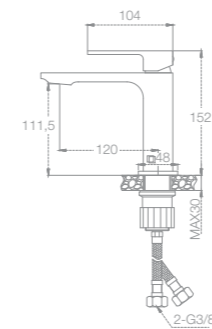

MONOMANDO LAVABO ALTO
REF. 68136 / 68136-Sline

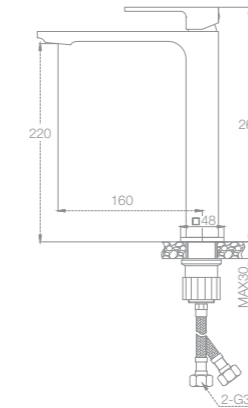

MONOMANDO BIDÉ
REF. 68132 / 68132-Sline

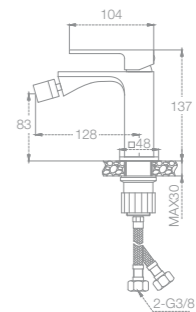

MONOMANDO BAÑO
REF. 68133 / 68133-Sline

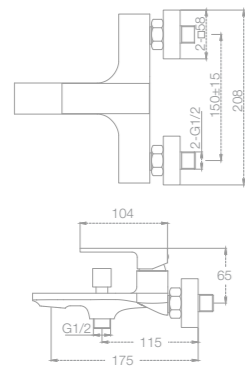

MONOMANDO DUCHA
REF. 68134 / 68134-Sline

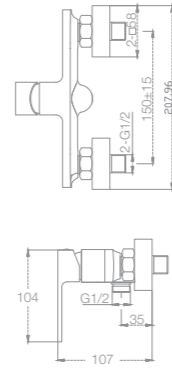

MONOMANDO FREGADERA BLACK
REF. 68125 / 68125-Sline

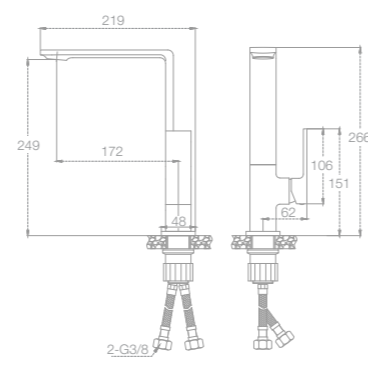

MONOMANDO LAVABO
REF. 68091 / 68091-Sline

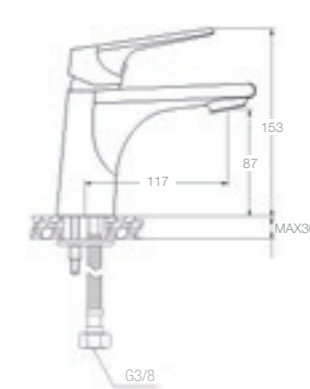

MONOMANDO BIDÉ
REF. 68092 / 68092-Sline

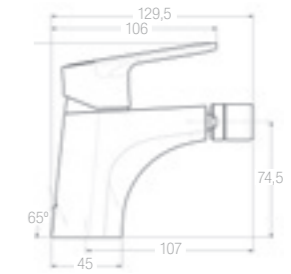

MONOMANDO FREGADERA CROMO
REF. 68135 / 68135-Sline

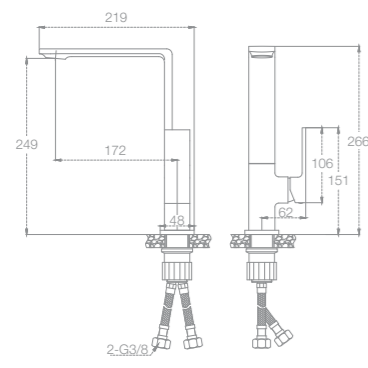

MONOMANDO LAVABO
REF. 68161 / 68161-Sline

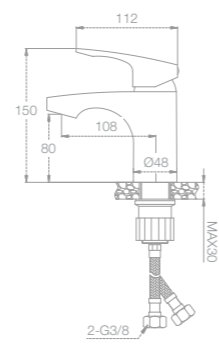

MONOMANDO BAÑO
REF. 68093 / 68093-Sline

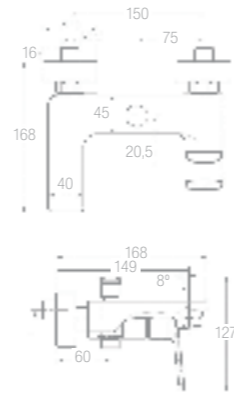

MONOMANDO DUCHA
REF. 68094 / 68094-Sline

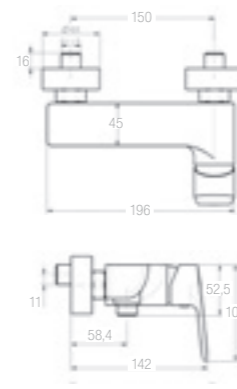

MONOMANDO FREGADERA CROMO
REF. 68095 / 68095-Sline

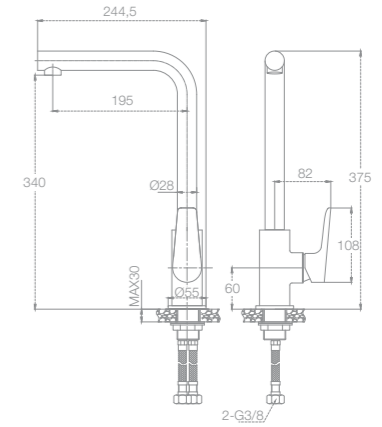

MONOMANDO BIDÉ
REF. 68162 / 68162-Sline

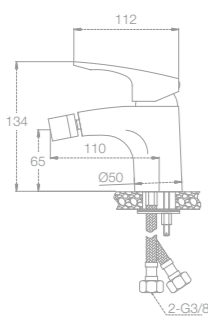

MONOMANDO BAÑO
REF. 68163 / 68163-Sline

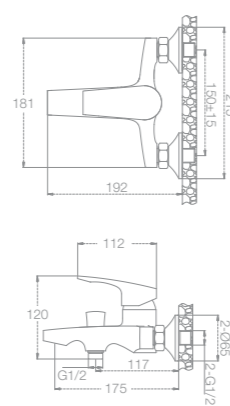

MONOMANDO DUCHA
REF. 68164 / 68164-Sline

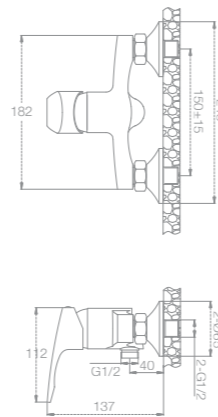

MONOMANDO FREGADERA BLACK
REF. 68096 / 68096-Sline

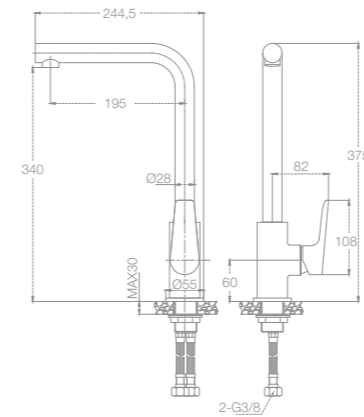

MONOMANDO LAVABO
REF. 68141 / 68141-Sline

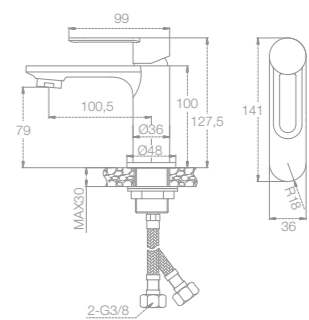

MONOMANDO LAVABO ALTO
REF. 68146 / 68146-Sline

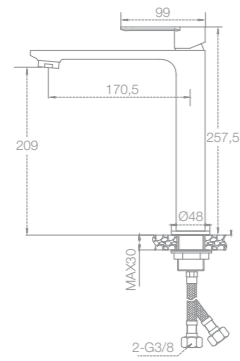

MONOMANDO BIDÉ
REF. 68142 / 68142-Sline

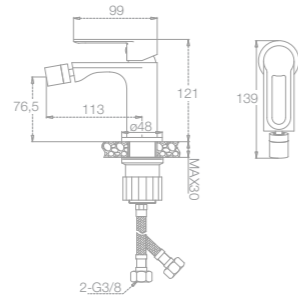

MONOMANDO BAÑO
REF. 68143 / 68143-Sline

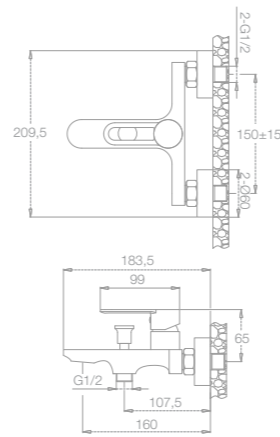

MONOMANDO BAÑO
REF. 68153 / 68153-Sline

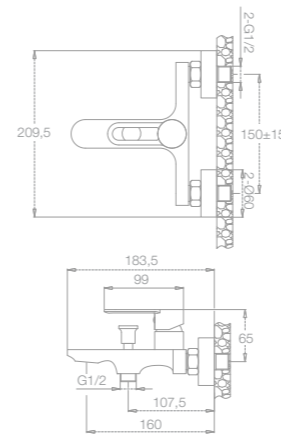

MONOMANDO DUCHA
REF. 68154 / 68154-Sline

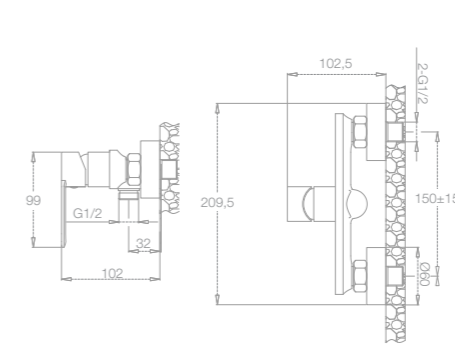

MONOMANDO FREGADERA
REF. 68155 / 68155-Sline

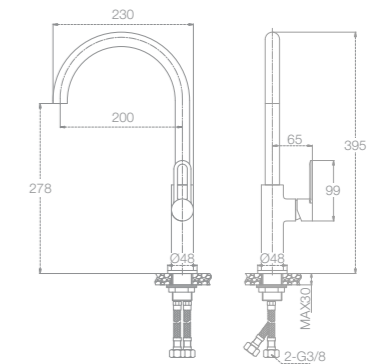

MONOMANDO DUCHA
REF. 68144 / 68144-Sline

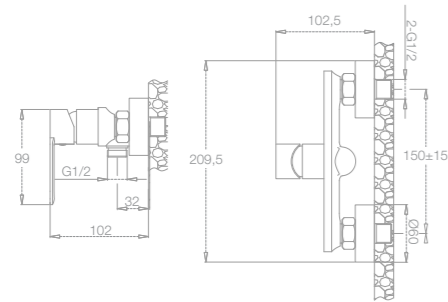

MONOMANDO FREGADERA
REF. 68145 / 68145-Sline

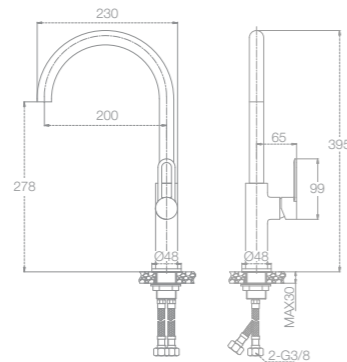

MONOMANDO LAVABO
REF. 68031 / 68031-Sline

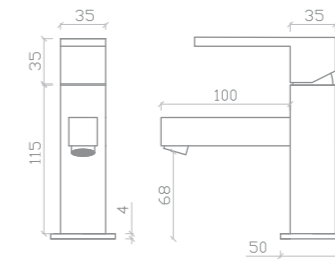

MONOMANDO BIDÉ
REF. 68032 / 68032-Sline

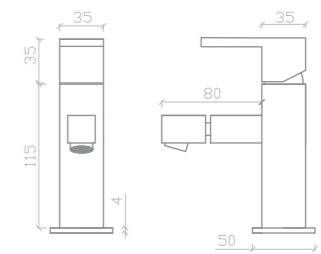

MONOMANDO LAVABO
REF. 68151 / 68151-Sline

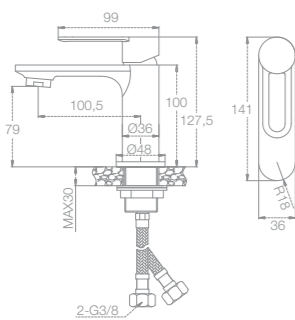

MONOMANDO LAVABO ALTO
REF. 68156 / 68156-Sline

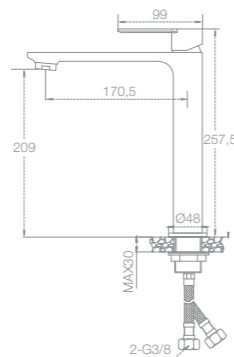

MONOMANDO BIDÉ
REF. 68152 / 68152-Sline

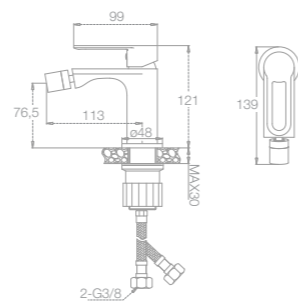

MONOMANDO BAÑO
REF. 68033 / 68033-Sline

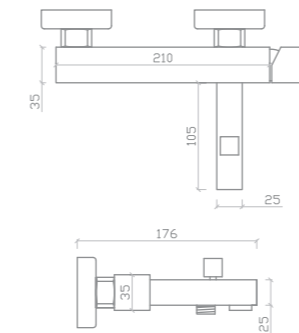

MONOMANDO DUCHA
REF. 68034 / 68034-Sline

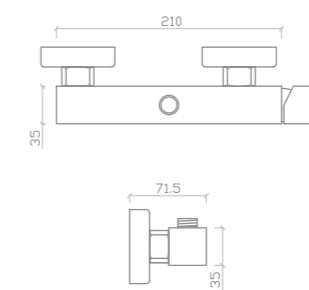

MONOMANDO FREGADERA
REF. 68036 / 68036-Sline

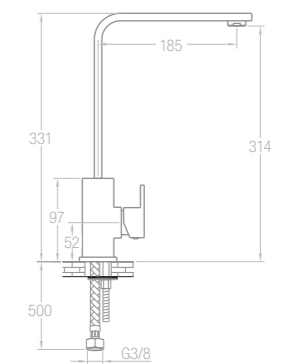

SERIE
CENTURY

SC

MONOMANDO LAVABO
REF. 68051

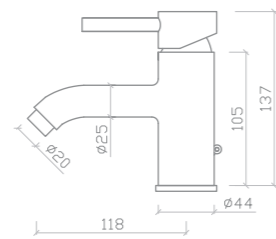

MONOMANDO BIDÉ
REF. 68052

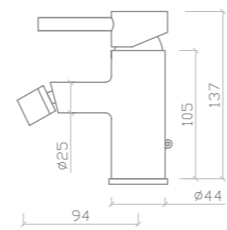

MONOMANDO DUCHA
REF. 68024

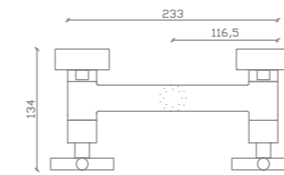

MONOMANDO FREGADERA
REF. 68026

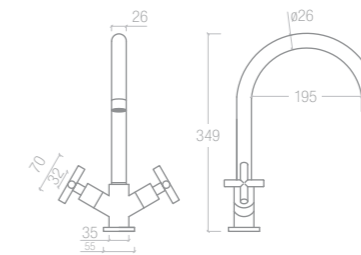

SERIE
NEVA

SN

MONOMANDO BAÑO
REF. 68053

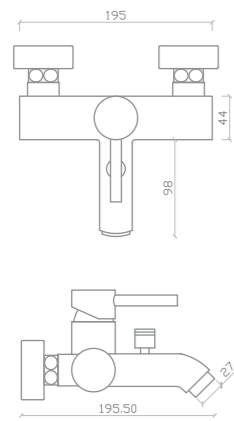

MONOMANDO DUCHA
REF. 68054

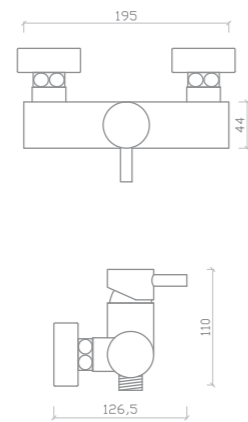

SERIE
STILO

SS

MONOMANDO LAVABO
REF. 68171



MONOMANDO BIDÉ
REF. 68172

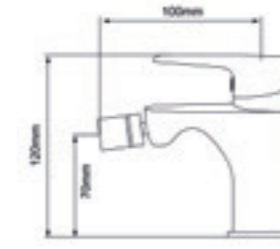

MONOMANDO BAÑO
REF. 68173

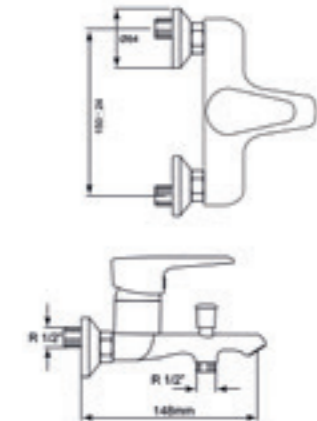

MONOMANDO LAVABO
REF. 68021

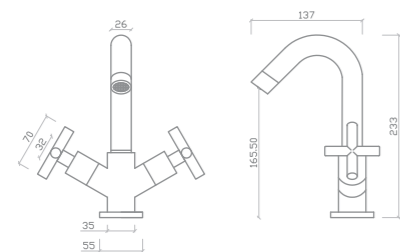

MONOMANDO BIDÉ
REF. 68022

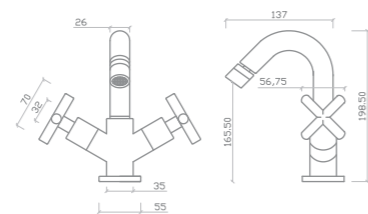

MONOMANDO BAÑO
REF. 68023

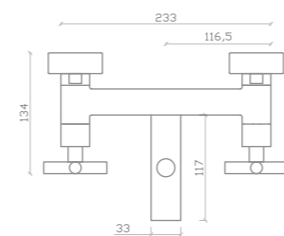

MONOMANDO DUCHA
REF. 68174

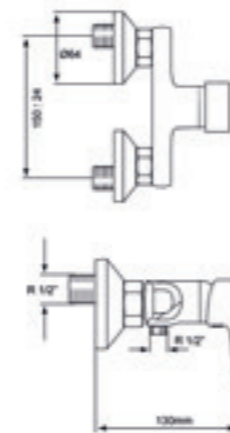

MONOMANDO FREGADERA
REF. 68175

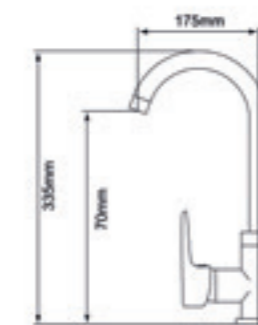

SERIE
NAVY

SNV

MONOMANDO LAVABO
REF. 68081

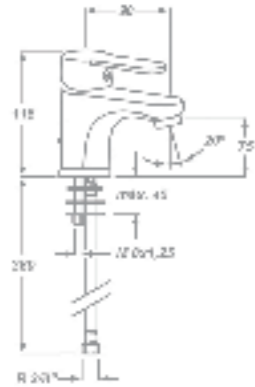

MONOMANDO BIDÉ
REF. 68082

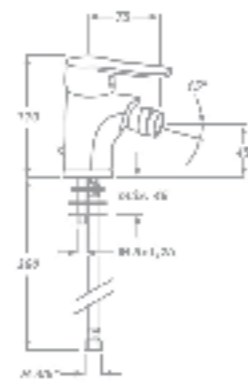

MONOMANDO BAÑO
REF. 68083

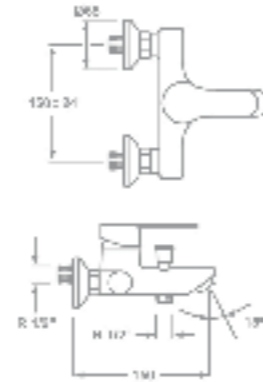

MONOMANDO DUCHA
REF. 68014

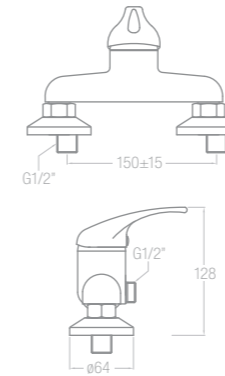

MONOMANDO FREGADERA VERTICAL
REF. 68016

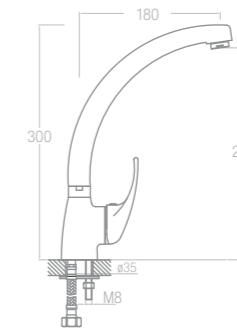

MONOMANDO FREGADERA V. (CAÑO FUNDIDO)
REF. 65802

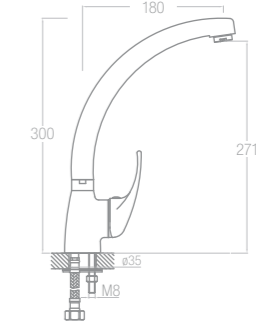

MONOMANDO DUCHA
REF. 68084

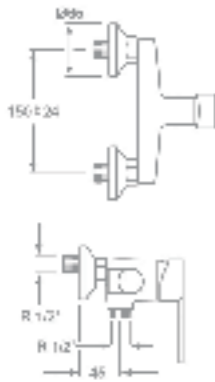

MONOMANDO FREGADERA
REF. 68085

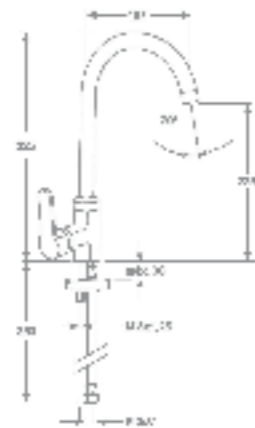

MONOMANDO FREGADERA VERTICAL BLANCO
REF. 65801

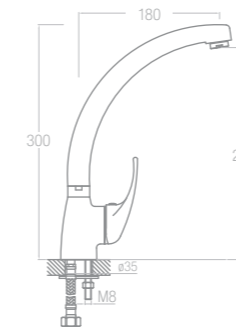

MONOMANDO FREGADERA V. TIERRA FRANCIA
REF. 65807

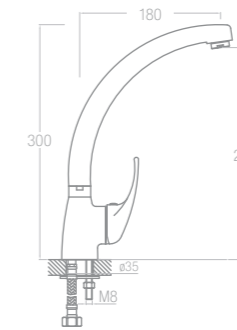

MONOMANDO FREGADERA "ECO" VERTICAL
REF. 65817

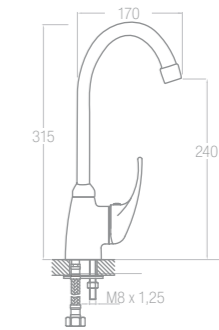

MONOMANDO LAVABO
REF. 68011

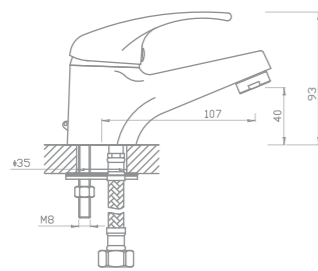

MONOMANDO BIDÉ
REF. 68012

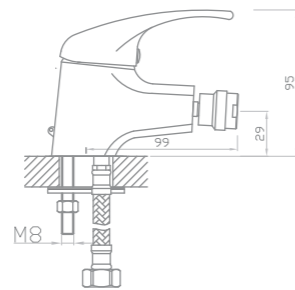

MONOMANDO BAÑO
REF. 68013

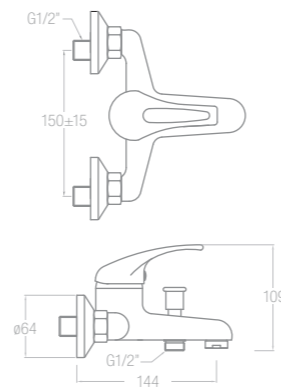

MONOMANDO FREGADERA HORIZONTAL
REF. 68017

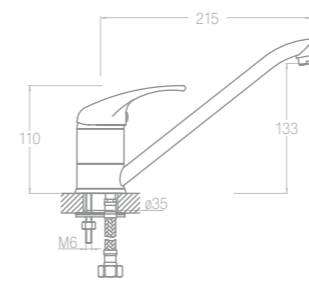

MONOMANDO FREGADERA EXTRAÍBLE V.
REF. 65806

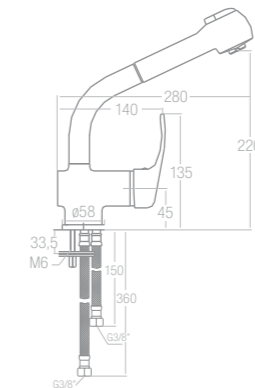

MONOMANDO FREGADERA EXTRAÍBLE H.
REF. 65805

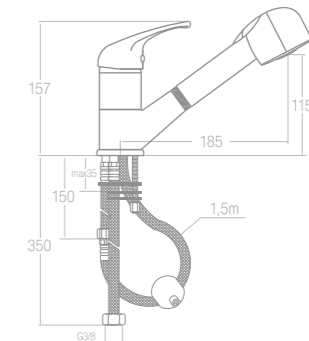

MONOMANDO FREGADERA PARED
REF. 65815 / 65816

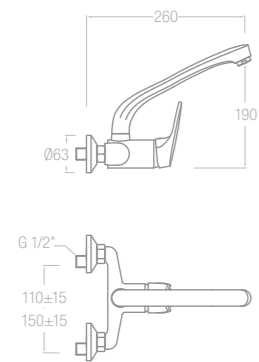

MONOM. FREGADERA PARED (CAÑO FUND.)
REF. 68018

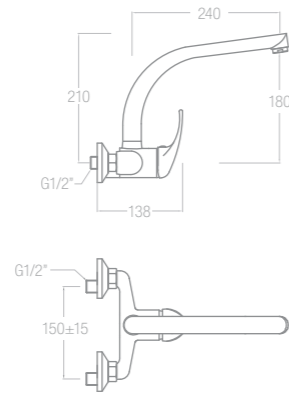

F8 MONOMANDO FREG.EXTRAÍBLE FLEXIBLE
REF. 65808 / 65808-Sline

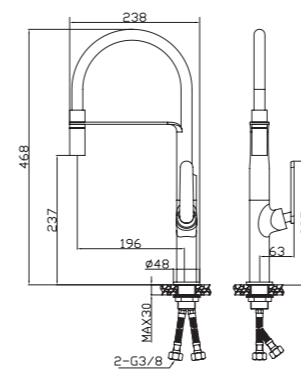

VEGA MONOMANDO FREGADERA NEGRO
REF. 68125 / 68125-Sline

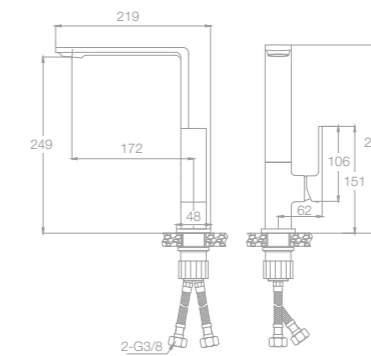

VEGA MONOMANDO FREGADERA CROMO
REF. 68135 / 68135-Sline

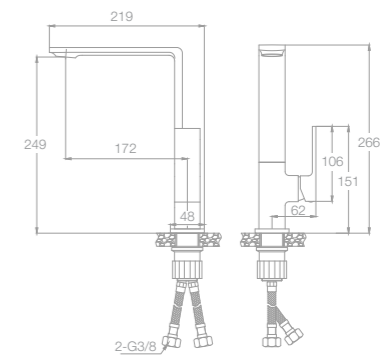

MONOMANDO LAVABO
REF. 14052

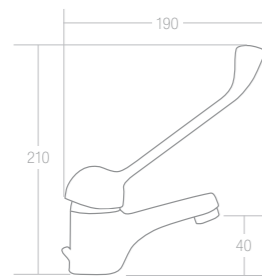

MONOMANDO FREGADERA HORIZONTAL
REF. 14053

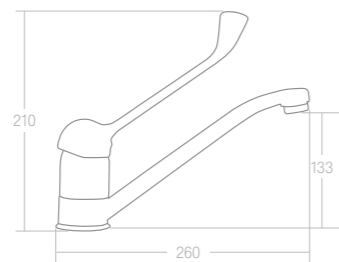

MONOMANDO FREGADERA PARED (CAÑO BAJO)
REF. 14054

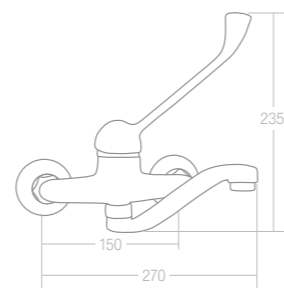

TENNA MONOMANDO FREGADERA CROMO
REF. 68095 / 68095-Sline

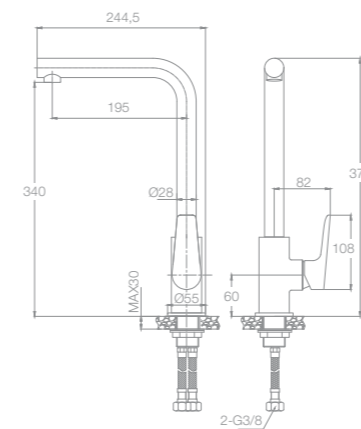

TENNA MONOMANDO FREGADERA BRONCO
REF. 68096 / 68096-Sline

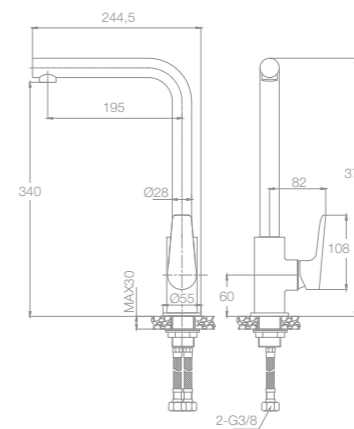

MAIA MONOMANDO FREGADERA
REF. 68145 / 68145-Sline

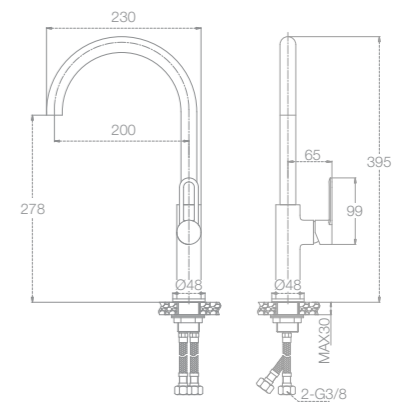

DUCHA MONOMANDO
REF. 14055

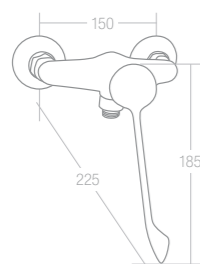

GRIFO FRONTAL LARGO 1/2
REF. 14051

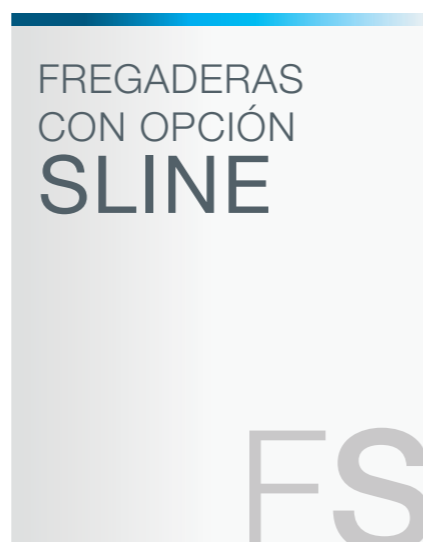
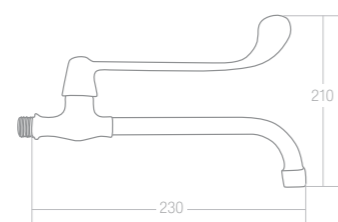

MAIA BLACK MONOMANDO FREGADERA NEGRO
REF. 68155 / 68155-Sline

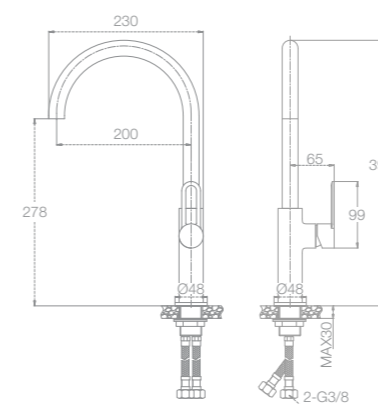

F14 MONOMANDO FREGADERA OSMOSIS (1 MANETA)
REF. 65814

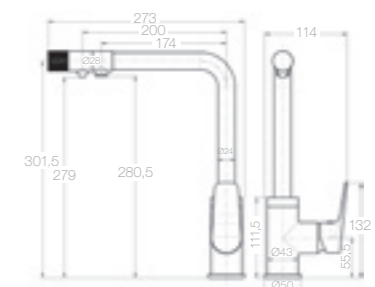

F13 MONOMANDO FREGADERA OSMOSIS CENTURY (2 MANETAS)
REF. 65813

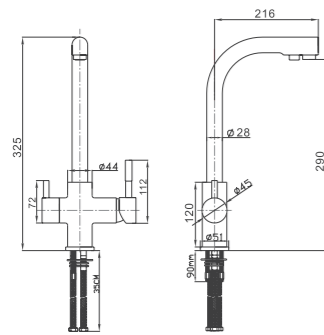

FREGADERAS EXTRAÍBLES

FE

F20 MONOMANDO FREGADERA EXTRAÍBLE
REF. 65820

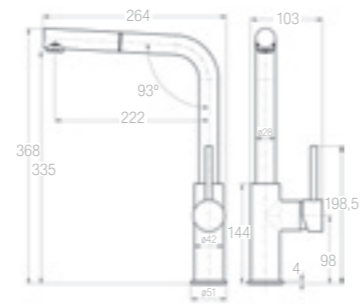

F21 MONOMANDO FREGADERA FLEXIBLE AZUL
REF. 65821

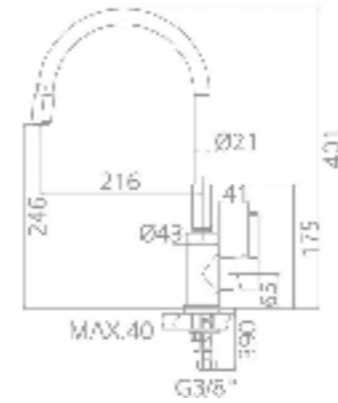

F22 MONOMANDO FREGADERA FLEXIBLE GRIS
REF. 65822

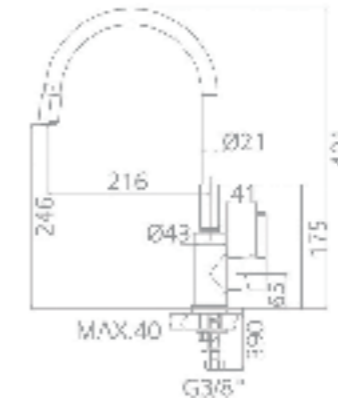

FREGADERAS LÍNEA ESSENCE

FE

OASIS MONOMANDO FREGADERA EXTRAÍBLE HORIZONTAL
REF. 65805

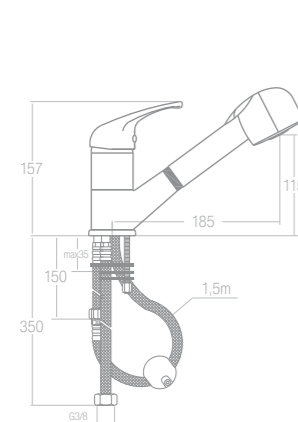

OASIS MONOMANDO FREGADERA EXTRAÍBLE VERTICAL
REF. 65806

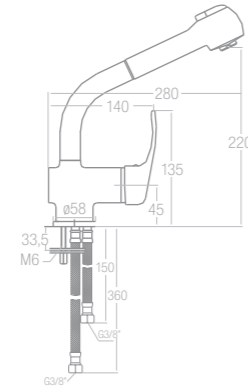

FREGADERAS FLEXIBLES

FF

CENTURY ABATIBLE MONOMANDO FREGADERA
REF. 65812

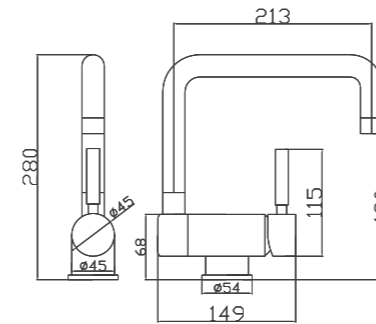

BEST MONOMANDO FREGADERA (CAÑO FUNDIDO)
REF. 68036

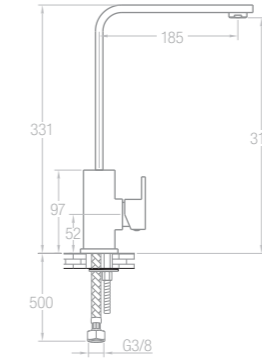

STILO BIMANDO FREGADERA
REF. 68026

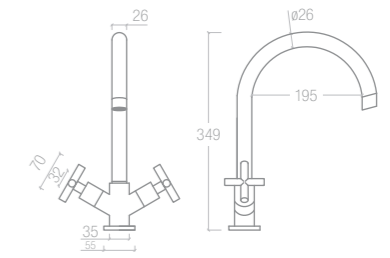

F9 MONOMANDO FREGADERA CON MUELLE EXTRAÍBLE
REF. 65809

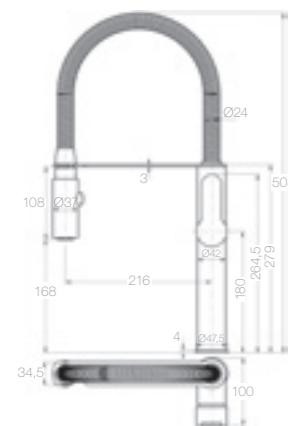

F18 MONOMANDO FREGADERA FLEXIBLE NEGRO
REF. 65818

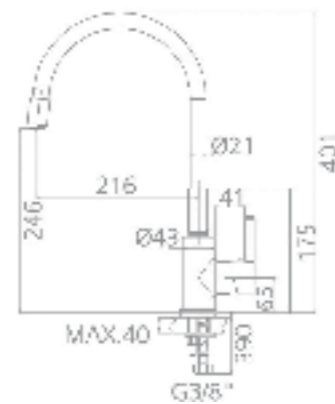

F19 MONOMANDO FREGADERA FLEXIBLE BLANCO
REF. 65819

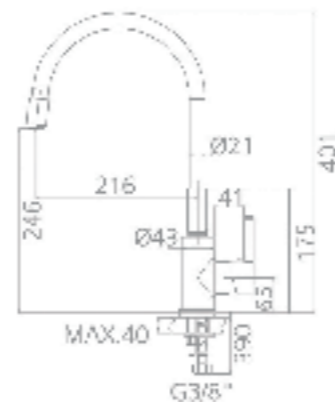

NEVA MONOMANDO FREGADERA
REF. 68175

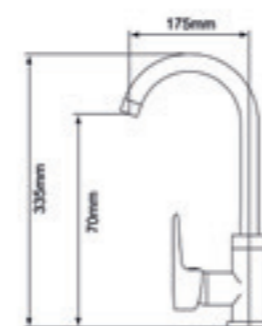

NEVA MONOMANDO FREGADERA CURVO
REF. 68050

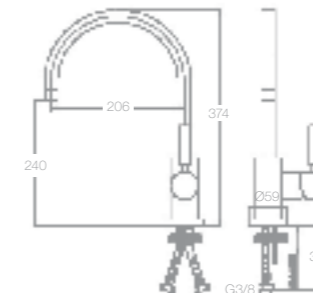

NAVY MONOMANDO FREGADERA
REF. 68085

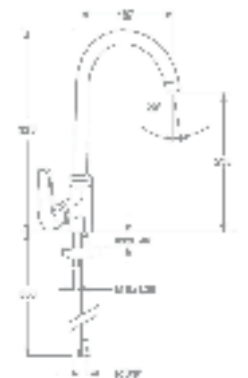

OASIS MONOMANDO FREGADERA VERTICAL
REF. 68016

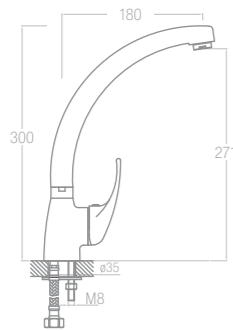

OASIS MONOMANDO FREGADERA VERTICAL
(CAÑO FUNDIDO)
REF. 65802

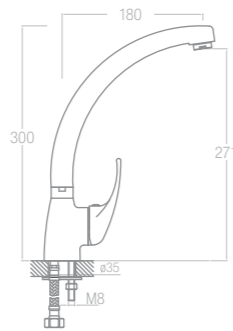

OASIS MONOMANDO FREGADERA VERTICAL
BLANCO
REF. 65801

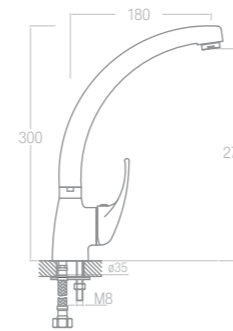

MONOMANDO FREGADERA PARED
(CAÑO BAJO)
REF. 14054

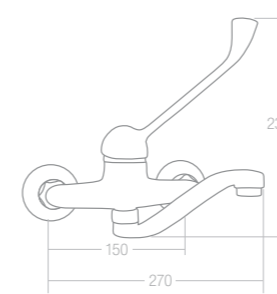

BATERÍA FREGADERA CAÑO HORIZONTAL
REF. 65901 / 65900 / 65903 / 65907

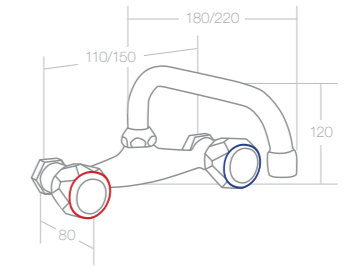

OASIS MONOMANDO FREGADERA VERTICAL
TIERRA FRANCIA
REF. 65807

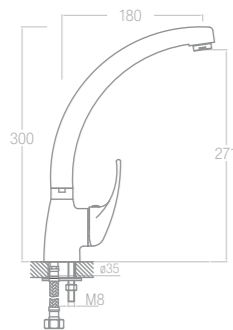

OASIS MONOMANDO FREGADERA "ECO"
VERTICAL
REF. 65817

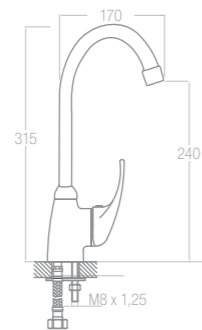

OASIS MONOMANDO FREGADERA
HORIZONTAL
REF. 68017

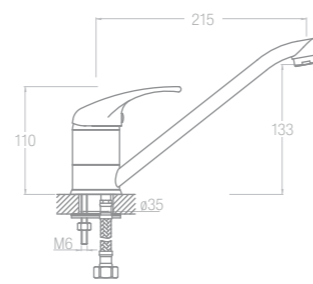

BATERÍA FREGADERA CAÑO VERTICAL
REF. 65905 / 65904

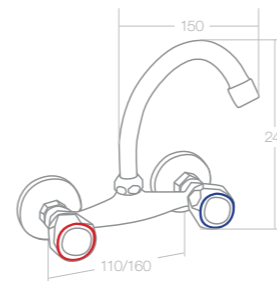

GRIFO FREGADERA GIRATORIO CAÑO
HORIZONTAL
REF. 65902

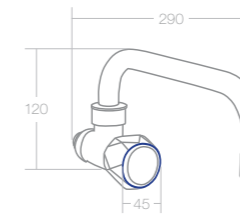

GRIFO FREGADERA GIRATORIO CAÑO
VERTICAL
REF. 65906

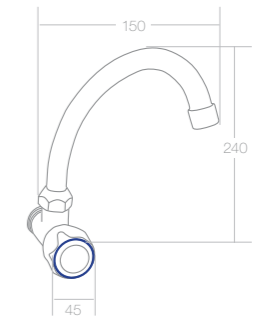

MEDICAL MONOMANDO FREGADERA
HORIZONTAL
REF. 14053

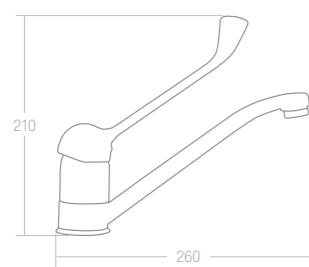

MONOMANDO FREGADERA PARED
REF. 65815 / 65816

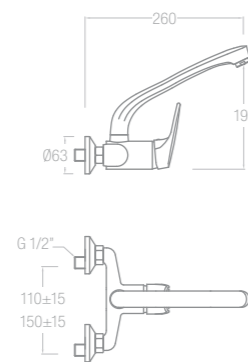

MONOMANDO FREGADERA PARED
(CAÑO FUNDIDO)
REF. 68018

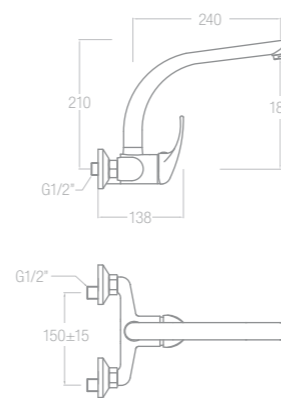

GRIFO MONOBLOC FREGADERA CAÑO
VERTICAL
REF. 65910

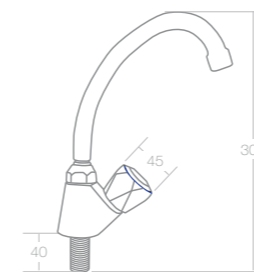

TERMOSTÁTICA DUCHA STANDARD
REF. 68040

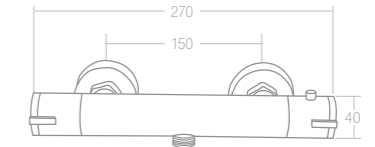

TERMOSTÁTICA DUCHA SQUARE
REF. 68044

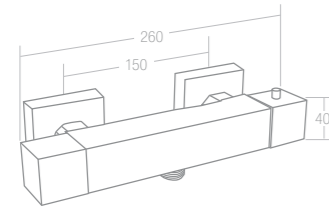

TERMOSTÁTICA BAÑO SQUARE
REF. 68041

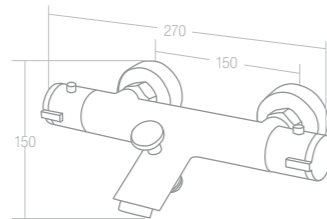

TERMOSTÁTICA BAÑO SQUARE
REF. 68045

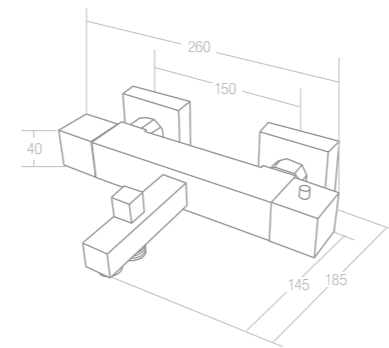

STAR ROUND GRIFO EMPOTRADO ELECTRÓNICO LAVABO
REF. 14016 / 14015

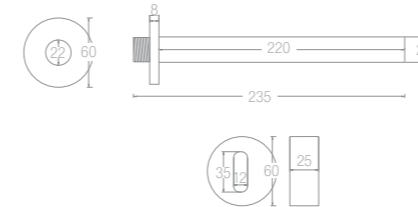

GRIFO T1 TEMPORIZADO LAVABO
REF. 14031

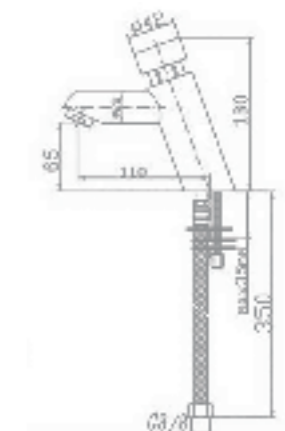

ERGO GRIFO ELECTRÓNICO LAVABO
REF. 14026 / 14025

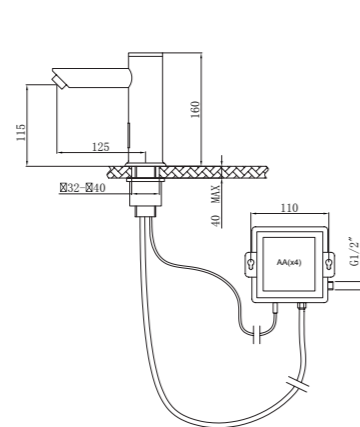

ERGO GRIFO ELECTRÓNICO LAVABO ALTO
REF. 14024 / 14023

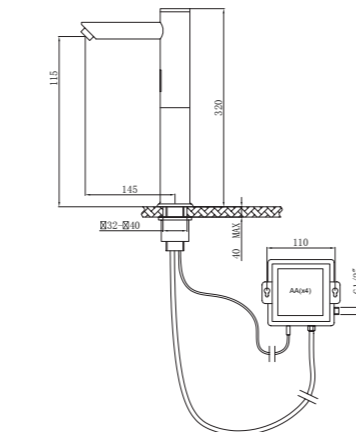

GRIFO T2 MEZCLADOR TEMPORIZADO LAVABO
REF. 14032

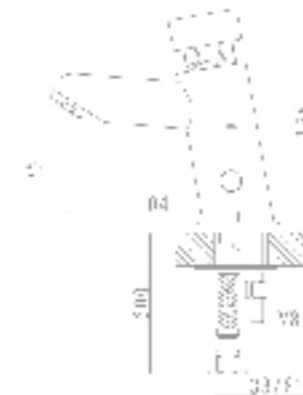

GRIFO TEMPORIZADOR LAVABO
REF. 14030

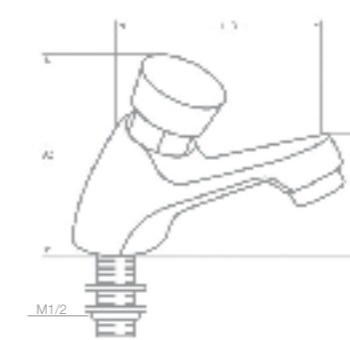

GRIFO TEMPORIZADO FRONTAL
REF. 14033

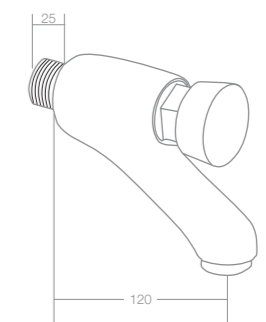

STAR SQUARE GRIFO ELECTRÓNICO LAVABO
REF. 14028 / 14027

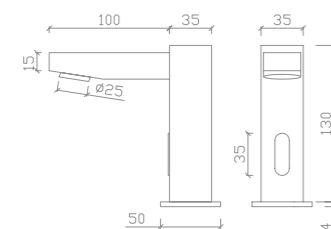

STAR SQUARE GRIFO EMPOTRADO ELECTRÓNICO
REF. 14018 / 14017

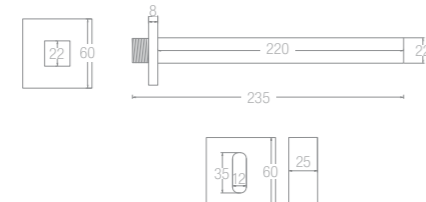

STAR ROUND GRIFO ELECTRÓNICO LAVABO
REF. 14034 / 14029

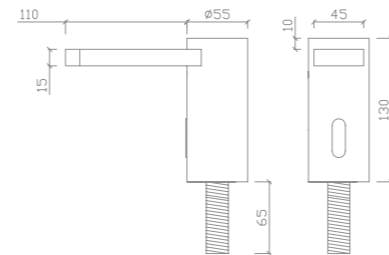

GRIFO TEMPORIZADO DUCHA EMPOTRAR
REF. 14037

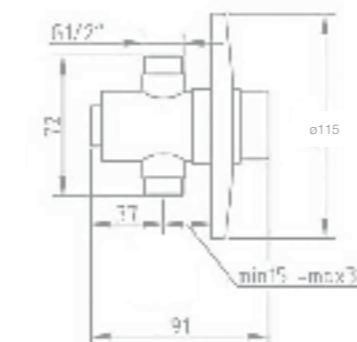

ROCIADOR LATÓN TOMA EMPOTRAR 1/2
REF. 59103

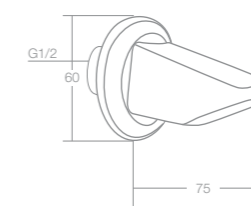

FLUXÓMETRO WC ENTRADA 3/4 SALIDA Ø28
REF. 14047

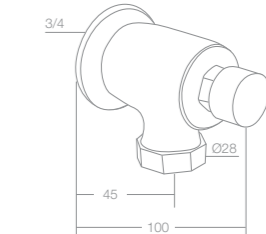

GRIFO TEMPORIZADO URINARIO FRONTAL
REF. 14035

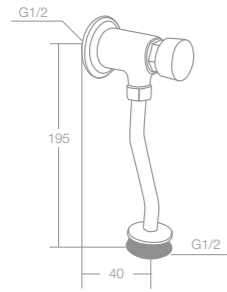

ACCESORIO TEMPORIZADO URINARIO 15,5 CM
REF. 14036

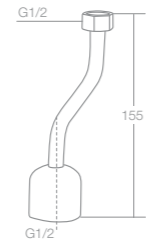

GRIFO TEMPORIZADO EMPOTRAR URINARIO
REF. 14038

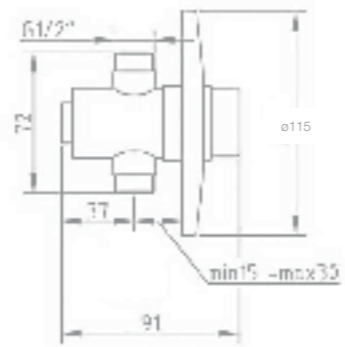

BEST MONOMANDO LAVABO EMPOTRAR
REF. 68231

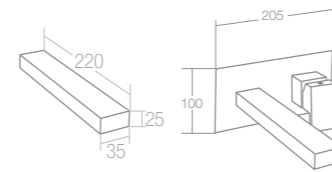

STAR SQUARE
GRIFO EMPOTRADO ELECTRÓNICO
REF. 14018 / 14017

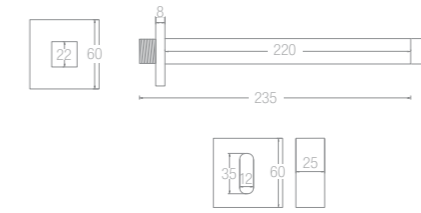

BEST MONOMANDO DUCHA EMPOTRAR 2 VÍAS
REF. 68233

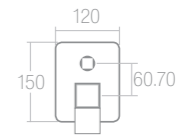

GRIFO PEDAL 1 AGUA ECO
REF. 14041

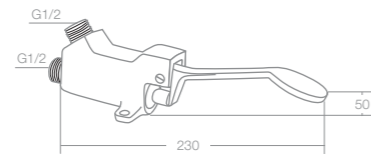

GRIFO PEDAL 2 AGUAS ECO
REF. 14048

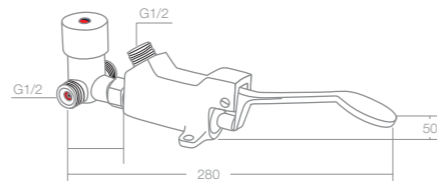

BEST MONOMANDO DUCHA EMPOTRAR 1 VÍA
REF. 68234

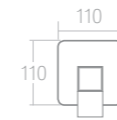

CENTURY MONOMANDO LAVABO EMPOTRAR
REF. 68251

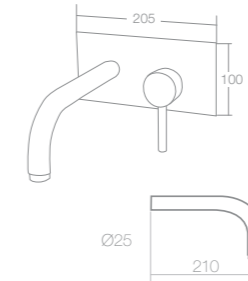

STAR ROUND GRIFO EMPOTRADO ELECTRÓNICO LAVABO
REF. 14016 / 14015

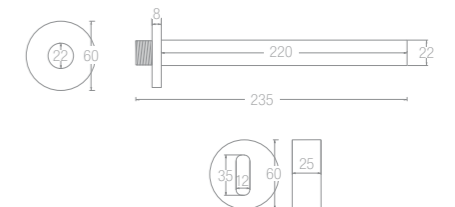

GRIFO PIE EMPOTRADO
REF. 14040

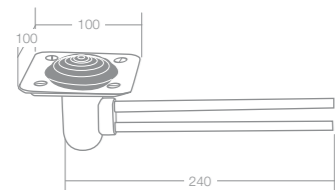

CAÑO GIRATORIO VERTICAL INCLINADO
REF. 14046

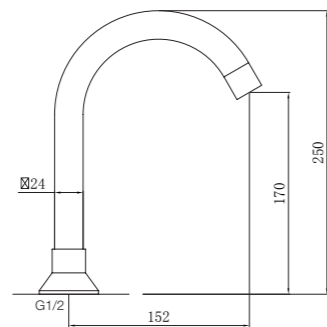

CENTURY MONOMANDO DUCHA EMPOTRAR 2 VÍAS
REF. 68253

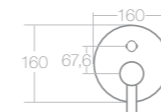

CENTURY MONOMANDO DUCHA EMPOTRAR 1 VÍA
REF. 68254



SET 1 BEST
REF. 68331

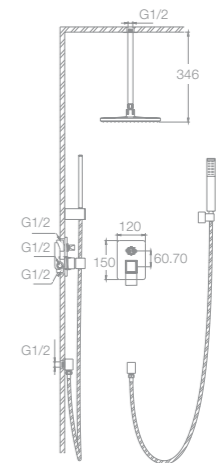

SET 2BEST

REF. 68332

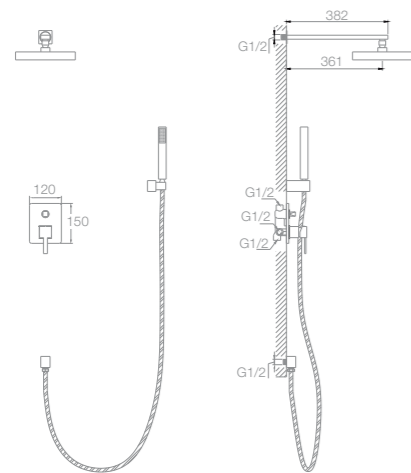

SET 3 BEST

REF. 68333

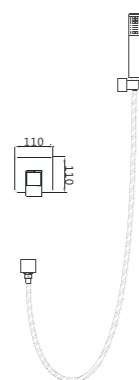

SET 4 BEST

REF. 68334

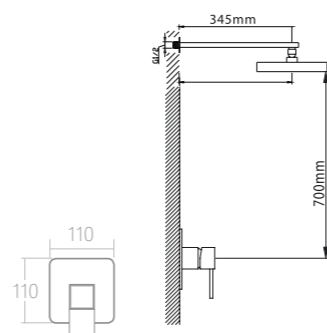

CESTA COLGAR GRIFERIA BLACK

REF. CA-62599

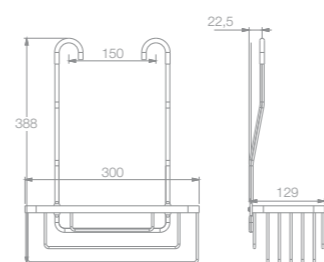

CESTA RECTANGULAR ALUMINIO

REF. CA-62597 / CA-62596

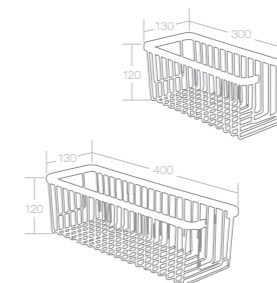

CESTA RECTANGULAR BLACK

REF. CA-62589

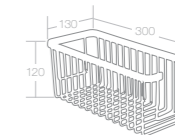

SET 1 CENTURY

REF. 68351

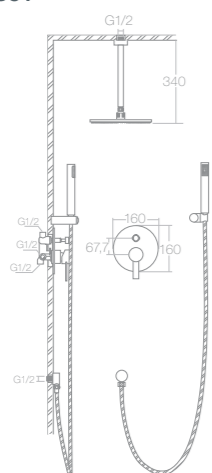

SET 2 CENTURY

REF. 68352

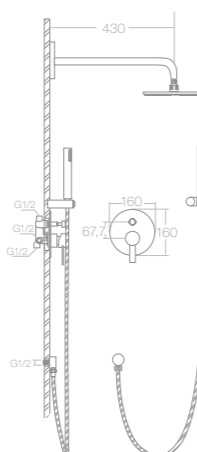

SET 3 CENTURY

REF. 68353



CESTA TRIANGULAR ALUMINIO

REF. CA-62595

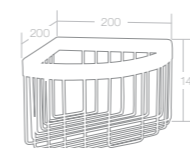

CESTA TRIANGULAR LATÓN

REF. CA-62591

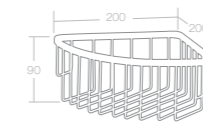

CESTA OVALADA LATÓN

REF. CA-62593

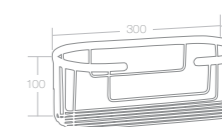

SET 4 CENTURY

REF. 68354

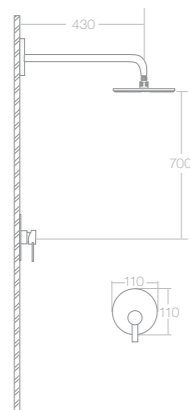

**COMPLEMENTOS
DUCHA**
CD

CESTA COLGAR GRIFERIA ALUMINIO

REF. CA-62598

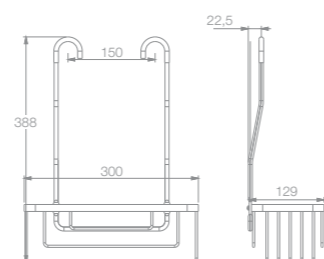

ASA RECTA CROMO Ø25

REF. CA-62571 / CA-62573
CA-62567 / CA-62568 / CA-62569

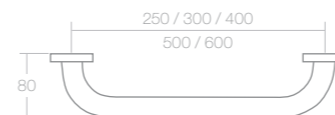

ASA RECTA BLANCA Ø25

REF. CA-62577 / CA-62578



ASA RECTA MATE Ø25

REF. CA-62572



ASA RECTA BRONCE Ø25
REF. CA-62570



ASA ANTIDESLIZANTE
REF. CA-62574



BARRA APOYO BRILLO Ø32
REF. 14001 / 14003

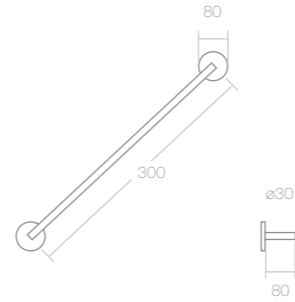

VÁLVULA CLIC-CLAC ABS-CROMO
REF. CA-41521



VÁLVULA CLIC-CLAC LATÓN-CROMO
REF. CA-41524



VÁLVULA CLIC-CLAC PARTE SUPERIOR
REF. CA-41528



BARRA APOYO SATINADA Ø32
REF. 14002 / 14004

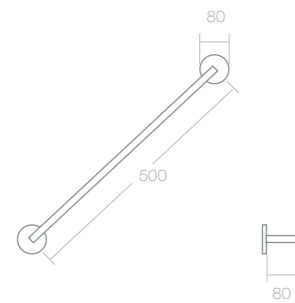

VÁLVULA CLIC-CLAC LATÓN-CROMO
REF. CA-41518



SIFÓN LUX / LATÓN-CROMO
REF. CA-41430

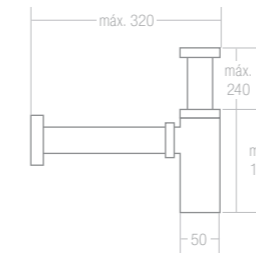

SIFÓN LUX / LATÓN-NEGRO
REF. CA-41428

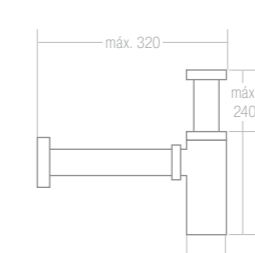

SIFÓN LUX / LATÓN-BLANCO
REF. CA-41429

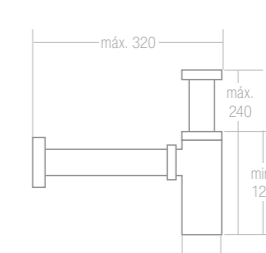

VÁLVULA CLIC-CLAC LATÓN-NEGRO
REF. CA-41519



VÁLVULA CLIC-CLAC LATÓN-PORCELANA
REF. CA-41517

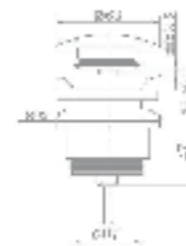

VÁLVULA CLIC-CLAC LATÓN-CROMO
REF. CA-41526



SIFÓN LUX / ABS-CROMO
REF. CA-41435

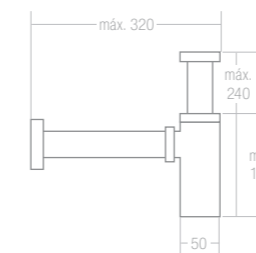

SIFÓN BOTELLA CROMADO
REF. CA-41432

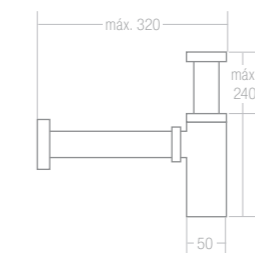

TOALLERO ANILLA CROMO
REF. 30621

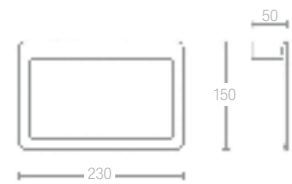

PORTARROLLOS CROMO
REF. 30622



PERCHA CROMO (2 UNIDADES)
REF. 30625

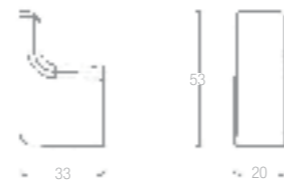

TOALLERO BARRA CROMO 45 CM
REF. 30626

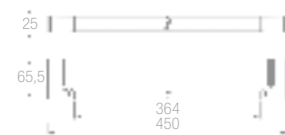

TOALLERO ANILLA BLACK
REF. 30611

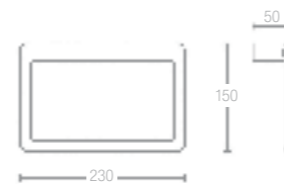

TOALLERO ANILLA CROMO
REF. CA-30601

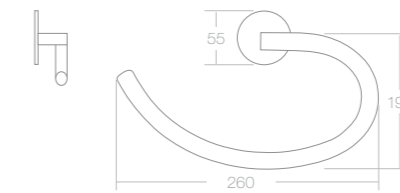

PORTARROLLOS CROMO
REF. CA-30602

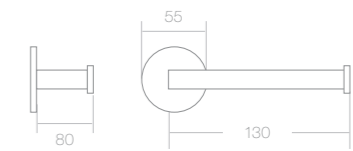

PERCHA CROMO TRIPLE
REF. CA-30604

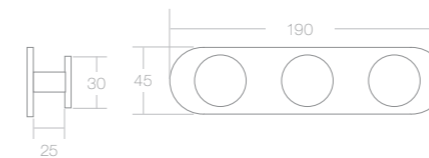

PERCHA CROMO
REF. CA-30605



TOALLERO BARRA CROMO 45 CM
REF. CA-30606

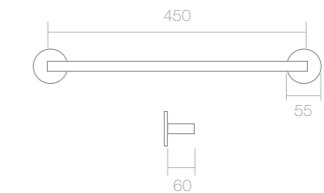

PORTARROLLOS BLACK
REF. 30612



PERCHA BLACK (2 UNIDADES)
REF. 30615

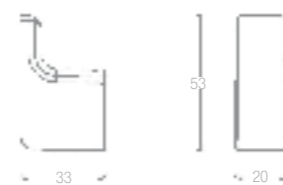

TOALLERO BARRA BLACK 45 CM
REF. 30616



TOALLERO PARA MUEBLE BAÑO/ COCINA
REF. CA-30270

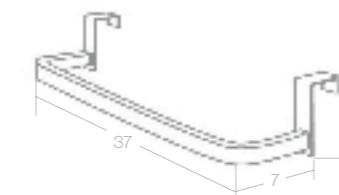

ESCOBILLERO CUADRADO ACERO INOX
REF. CA-62580

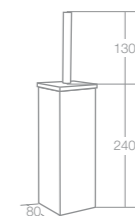

ESCOBILLERO CILÍNDRICO ACERO INOX

REF. CA-62508

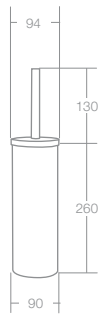

ESCOBILLERO CÓNICO BLANCO

REF. 62506

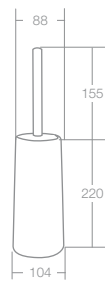

ESCOBILLERO CÓNICO GRIS

REF. 62507

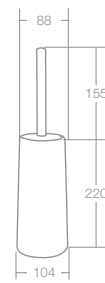

ESCOBILLERO CÓNICO NEGRO

REF. 62504

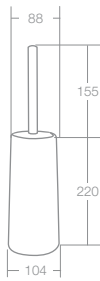

DOSIFICADOR PIE ACERO INOX CON PEDAL

REF. CA-62600

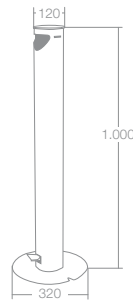

DOSIFICADOR DSW1100 ELECTRÓNICO

REF. CA-62604

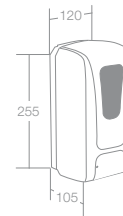

Water is the Future