



dos mil veintitres

**NAVARTI**  
*cerámica*

welcome



## bienvenidos a navarti

### ES

Desde 2014 y con más de 20 años de experiencia en el sector, Navarti Cerámica trabaja día a día en construir unos fuertes valores basados en el diseño, la innovación y la calidad de nuestro producto. Todo esto unido a una atención al cliente de calidad junto con una fuerte presencia en el mercado tanto a nivel nacional como internacional.

Gracias al avance de nuestras tecnologías y a un equipo proactivo e inconformista, Navarti es sinónimo de evolución y buen gusto. El compromiso medioambiental nos define, ya que utilizamos procesos de fabricación que simplifican de manera significativa la huella de carbono en el planeta Tierra. Y como muestra de ello, poseemos diversos certificados, en los cuales se reconocen estrategias y prácticas de construcción sostenible, saludables y altamente eficientes.

En este catálogo, a través de la amplia variedad de colecciones que presentamos, buscamos satisfacer todo tipo de gustos y necesidades. Todo ello gracias al multiformato, a los distintos acabados y reproducciones altamente fieles a los materiales reales.

Pero sobretodo, queremos servir de inspiración y poder acompañar a las personas en su proyecto de vida.

### EN

Since 2014 and with more than 20 years of experience in the sector, Navarti Cerámica works every day to build strong values based on the design, innovation and quality of our product. All this coupled with quality customer service together with a strong presence in the market both nationally and internationally.

Thanks to the advancement of our technologies and a proactive and non-conformist team, Navarti is synonymous with evolution and good taste. Our environmental commitment defines us, as we use manufacturing processes that significantly simplify the carbon footprint on planet Earth. And as proof of this, we have various certificates, in which sustainable, healthy and highly efficient construction strategies and practices are recognized.

In this catalog, through the wide variety of collections that we present, we seek to satisfy all kinds of tastes and needs. All this thanks to the multi-format, the different finishes and reproductions highly faithful to real materials.

But above all, we want to serve as inspiration and be able to accompany people in their life project.



## compromiso medioambiental

### ES

Navarti Cerámica cuenta con un sistema de gestión ambiental para **identificar y minimizar el impacto** de sus operaciones sobre las emisiones atmosféricas, aguas residuales, residuos y contaminación acústica.

La compañía está comprometida con el cumplimiento de las disposiciones legales en material medioambiental. Navarti cuenta con la **Autorización Ambiental Integrada**, otorgada por la Conselleria de Territorio y Vivienda de la Generalitat Valenciana. A parte, aplicando criterios de mejora continua, lleva a cabo una valorización interna de los residuos y una recogida selectiva de los mismos como cartón, plástico o madera.

Otro imput que Navarti tiene en cuenta, es el compromiso con la mejora en la gestión del agua, basada en los principios de reutilización y optimización de la misma en diferentes procesos. Además, apuesta por la aplicación constante de criterios de eficiencia energética en sus instalaciones y actividades. La compañía cuenta con **Declaraciones Ambientales de Producto** (DAP) para todas las familias de producto que comercializa. Una declaración concedida por Aenor en 2014 y ampliada en 2015 que destaca productos respetuosos con el medio ambiente.

### EN

Navarti Cerámica has an environmental management system to identify and minimize the impact of its operations on atmospheric emissions, wastewater, waste and noise pollution.

The company is committed to complying with legal provisions on environmental matters. Navarti has the Integrated Environmental Authorization, granted by the Department of Territory and Housing of the Generalitat Valenciana. In addition, applying criteria of continuous improvement, it carries out an internal recovery of waste and a selective collection of the same as cardboard, plastic or wood.

Another imput that Navarti takes into account is the commitment to improving water management, based on the principles of reuse and optimization of it in different processes. In addition, it is committed to the constant application of energy efficiency criteria in its facilities and activities. The company has Environmental Product Declarations (DAP) for all the product families it markets. A statement granted by Aenor in 2014 and extended in 2015 that highlights environmentally friendly products.









Revestimiento /  
Wall Tiles



Pavimento /  
Floor Tiles



Pavimento ADZ /  
ADZ Floor Tile



Pavimento ADZ bajo demanda /  
ADZ Floor Tile on request



Mate /  
Matt



Pulido /  
Polished



Granilla pulida /  
Highly Polished



Brillo /  
Gloss



Lappato /  
Lappato



Masa coloreada /  
Colored body



Digital /  
Digital



Rectificado /  
Rectified



Pasta Blanca /  
White body



Pasta roja /  
Red body



Porcelánico /  
Porcelain



Sugar Lappato



Variación leve /  
Slight variation



Variación moderada /  
Moderate variation



Variación alta /  
Strong variation



No trabado mitad de pieza /  
Not brick-jointed half

**TECHNICAL PORCELAIN**  
Porcelánico Masa Coloreada

14

96

**20MM THICKNESS**  
Espesorado 20MM

**HIGHLY POLISHED**  
Granilla Pulida

140

162

**SUGAR LAPPATO**  
Sugar Lappato

**POLISHED PORCELAIN**  
Porcelánico Pulido

176

286

**XTRA**  
6 mm

**WHITE BODY WALL TILE**  
Revest. Pasta Blanca

306

364

**SMALL SIZES**  
Pequeños formatos

**GLAZED PORCELAIN**  
Porcelánico Esmaltado

372

448

**WOOD PORCELAIN**  
Porcelánico Maderas

**RED BODY FLOOR TILE**  
Pav. Pasta Roja

478

492

**RED BODY WALL TILE**  
Revest. Pasta Roja







technical

porcelain

## DE

Unser Sortiment ist an die höchsten technischen Anforderungen angepasst.

## FR

Notre gamme adaptée aux exigences techniques les plus élevées.

## EN

Our new range created to suit the market's technical needs.

## ES

Nuestra gama adaptada a las mayores exigencias técnicas.

antibes • calcare • chrome • cuzco • ecchio • gerhy • grain stone  
inka • method • petrae • street • valdivia • ziro





antibes

Antibes grey 120x120 / 48"x48"





Mate Rectificado /  
 Rectified Mat Porcelain /  
 Matt Rektifiziert /  
 Mat Rectifié /



**Antibes grey** 90x90 / 36"x36"  
**Muretto Antibes grey** 17x52 / 7"x21"  
**Fanlo haya** 25x150 / 10"x59"



# antibes

DCOF



pavimento \_ porcelánico \_ rectificado \_ masa coloreada \_ mate  
 floor tile \_ porcelain \_ rectified \_ colored body \_ matt



Los tamaños 30x60 y 60x60 se puede suministrar antideslizantes.  
 The sizes 30x60 and 60x60 can be supplied non-slip.  
 Les tailles 30x60 et 60x60 peuvent être fournies antidérapantes.  
 Die Größen 30x60 und 60x60 können rutschfest geliefert werden.



Serie susceptible de tratamiento antideslizante bajo demanda excepto en 45x45.  
 Series susceptible to anti-slip treatment on request except in 45x45.  
 Série sensible au traitement antidérapant sur demande sauf en 45x45..  
 Serie mit Antirutschbehandlung auf Anfrage außer in 45x45.

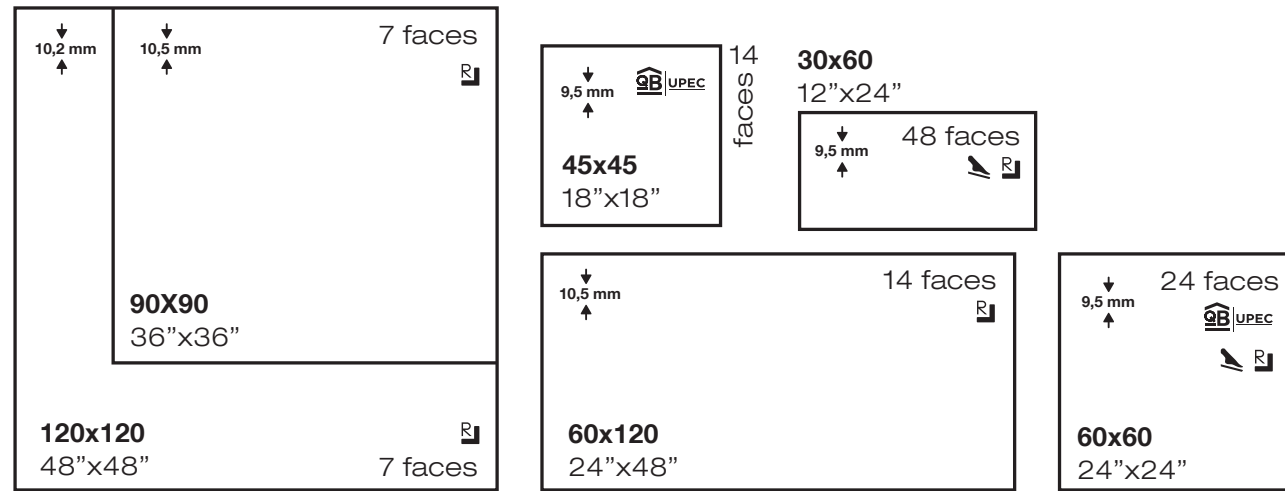

## PACKING & SPECIAL PIECES

	Pc/Cj	M2/Cj	Cj/Pl	M2/Pl	Kg/Cj	Kg/Pl
30x60	6	1,08	48	51,84	23,6	1152,8
45x45	6	1,22	52	63,44	25,8	1361,6
60x60	4	1,44	30	43,2	30	920
60x120	2	1,44	32	46,08	34,5	1124
90x90	2	1,62	27	43,74	40	1100
120x120	1	1,44	36	51,84	36,36	1328,96

	Rect. Mate	Mate	ADZ
30x60	MP126	-	MP125
45x45	-	MP136	-
60x60	MP175	-	MP173
60x120	MP320	-	-
90x90	MP207	-	-
120x120	M330	-	-

Ver página 583  
 See page 583

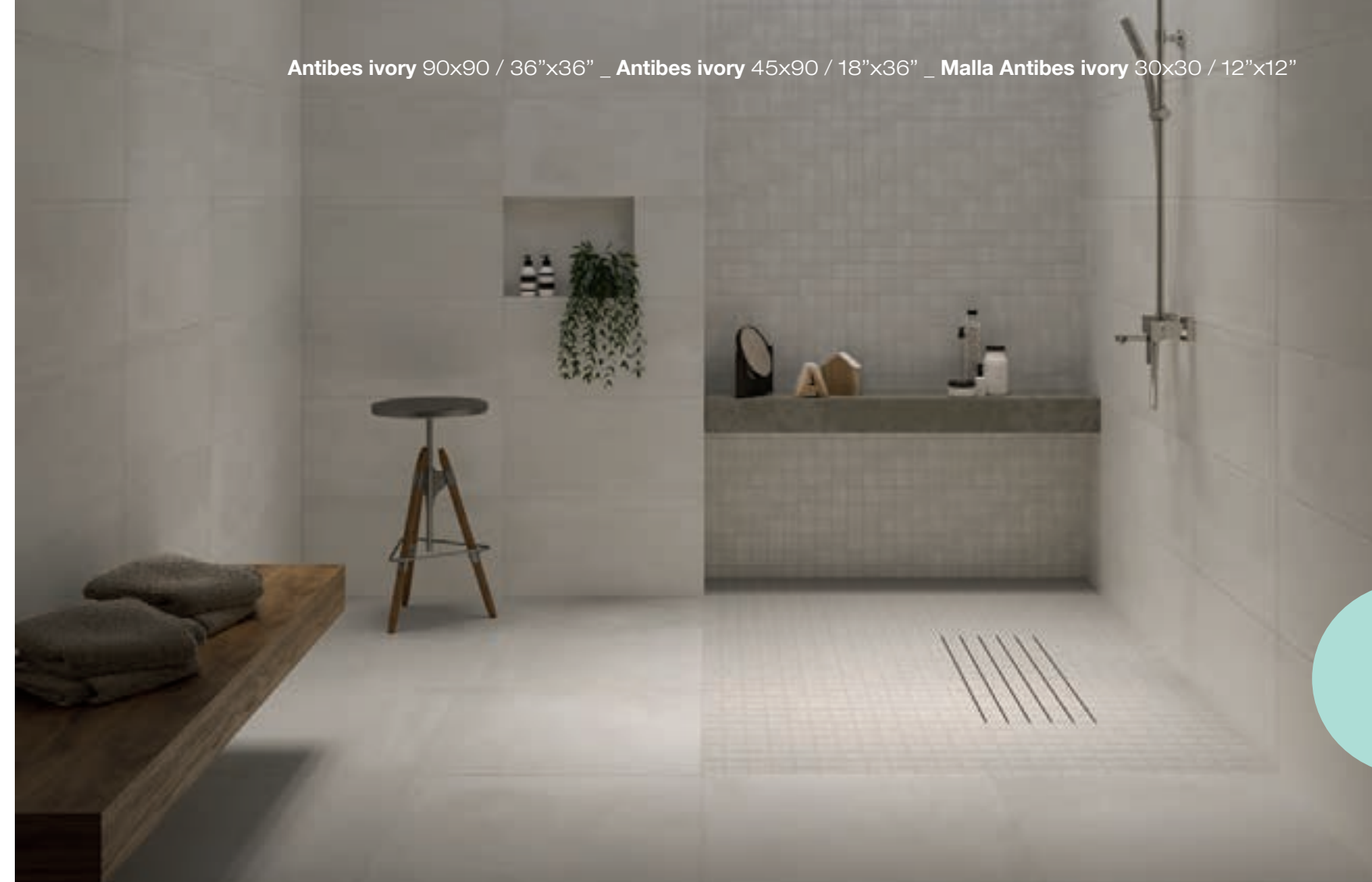
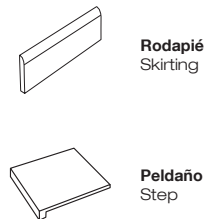

Antibes ivory 90x90 / 36"x36" \_ Antibes ivory 45x90 / 18"x36" \_ Malla Antibes ivory 30x30 / 12"x12"





calcare

Calcare pearl 90x90 / 36"x36" \_ Calcare pearl 30x90 / 12"x36" \_ Mosaico Calcare pearl 30x30 / 12"x12"





Mate Rectificado /

Rectified Mat Porcelain /

Matt Rektifiziert /

Mat Rectifié /

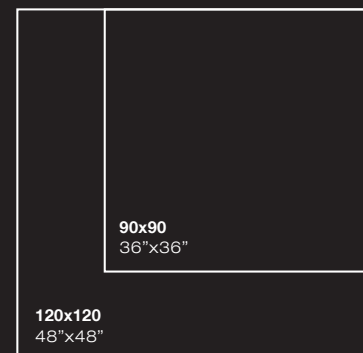

Calcare grey 120x120 / 48"x48"



# calcare

DCOF



pavimento \_ porcelánico \_ rectificado \_ masa coloreada \_ mate  
 floor tile \_ porcelain \_ rectified \_ colored body \_ matt



**Serie susceptible de tratamiento antideslizante bajo demanda excepto en 45x45.**  
 Series susceptible to anti-slip treatment on request except in 45x45.  
 Série sensible au traitement antidérapant sur demande sauf en 45x45..  
 Serie mit Antirutschbehandlung auf Anfrage außer in 45x45.

30x30 MP185



**Mosaicos**  
 Mosaics  
 Mosaïques  
 Mosaik

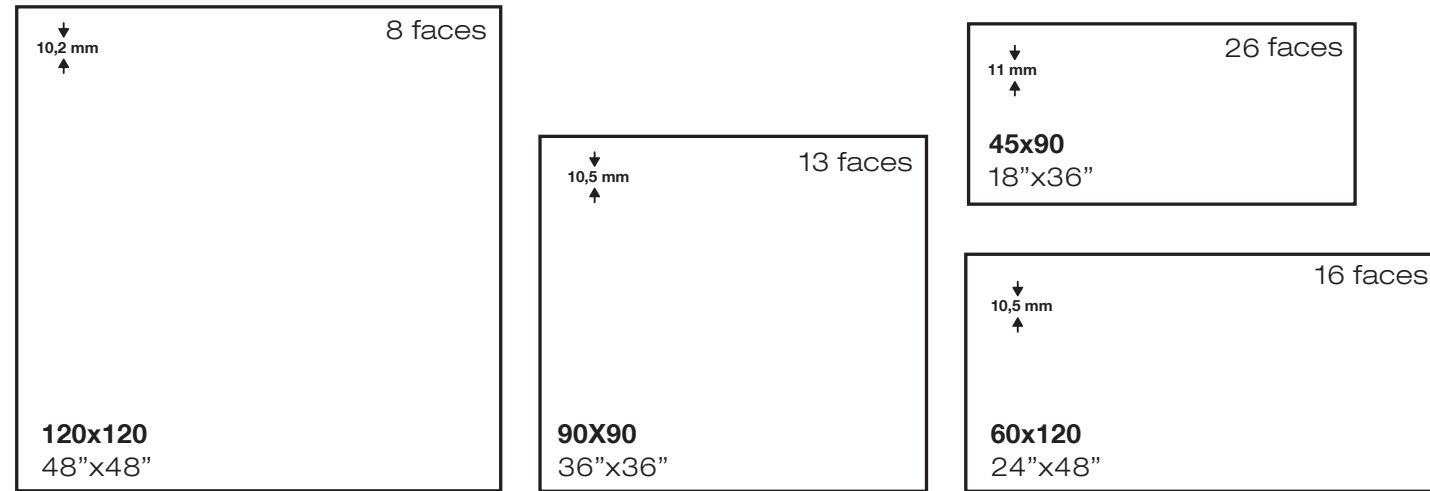

## PACKING & SPECIAL PIECES

	Pc/Cj	M2/Cj	Cj/PI	M2/PI	Kg/Cj	Kg/PI
<b>45x90</b>	3	1,21	44	53,24	28,7	1282,8
<b>60x120</b>	2	1,44	32	46,08	34,5	1124
<b>90x90</b>	2	1,62	27	43,74	40	1100
<b>120x120</b>	1	1,44	36	51,84	36,36	1328,96

	Rect.
<b>45x90</b>	MP300
<b>60x120</b>	MP320
<b>90x90</b>	MP207
<b>120x120</b>	MP330

**Ver página 583**  
 See page 583

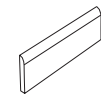

**Rodapié**  
 Skirting

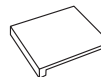

**Peldaño**  
 Step

Calcare cream 90x90 / 36"x36" \_ Calcare cream 30x90 / 12"x36" \_ Riv Enzo cream 30x90 / 12"x36"



bone

cream

pearl

grey





chrome

Chrome white 60x120 / 24"x48





Mate Rectificado /

Rectified Mat Porcelain /

Matt Rektifiziert /

Mat Rectifié /

60x120  
24"x48"

Floor \_ **Antibes pearl 20mm** 60,5x60,5 / 24"x24"

Wall \_ **Chrome white** 60x120 / 24"x48"

Wall \_ **Chrome graphite** 60x120 / 24"x48"



# chrome

DCOF



pavimento \_ porcelánico \_ rectificado \_ masa coloreada \_ mate \_ lappato  
 floor tile \_ porcelain \_ rectified \_ colored body \_ matt \_ lappato



**Serie susceptible de tratamiento antideslizante bajo demanda.**  
 Series susceptible to anti-slip treatment on request.  
 Série sensible au traitement antidérapant sur demande.  
 Serie mit Antirutschbehandlung auf Anfrage.



**30x30 MP185 Mosaicos**  
 Mosaics  
 Mosaïques  
 Mosaik

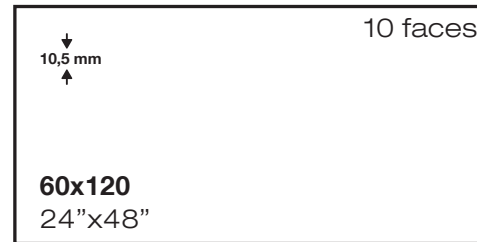

## PACKING & SPECIAL PIECES

	Pc/Cj	M2/Cj	Cj/Pl	M2/Pl	Kg/Cj	Kg/Pl
<b>60x120</b>	2	1,44	32	46,08	34,5	1124

	Mate	Lappato
<b>60x120</b>	MP320	MP440

**Ver página 583**  
 See page 583



**Rodapié**  
 Skirting

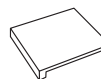

**Peldaño**  
 Step

Chrome fire 60x120 / 24"x48" \_ Aeris 60x120 / 24"x48"





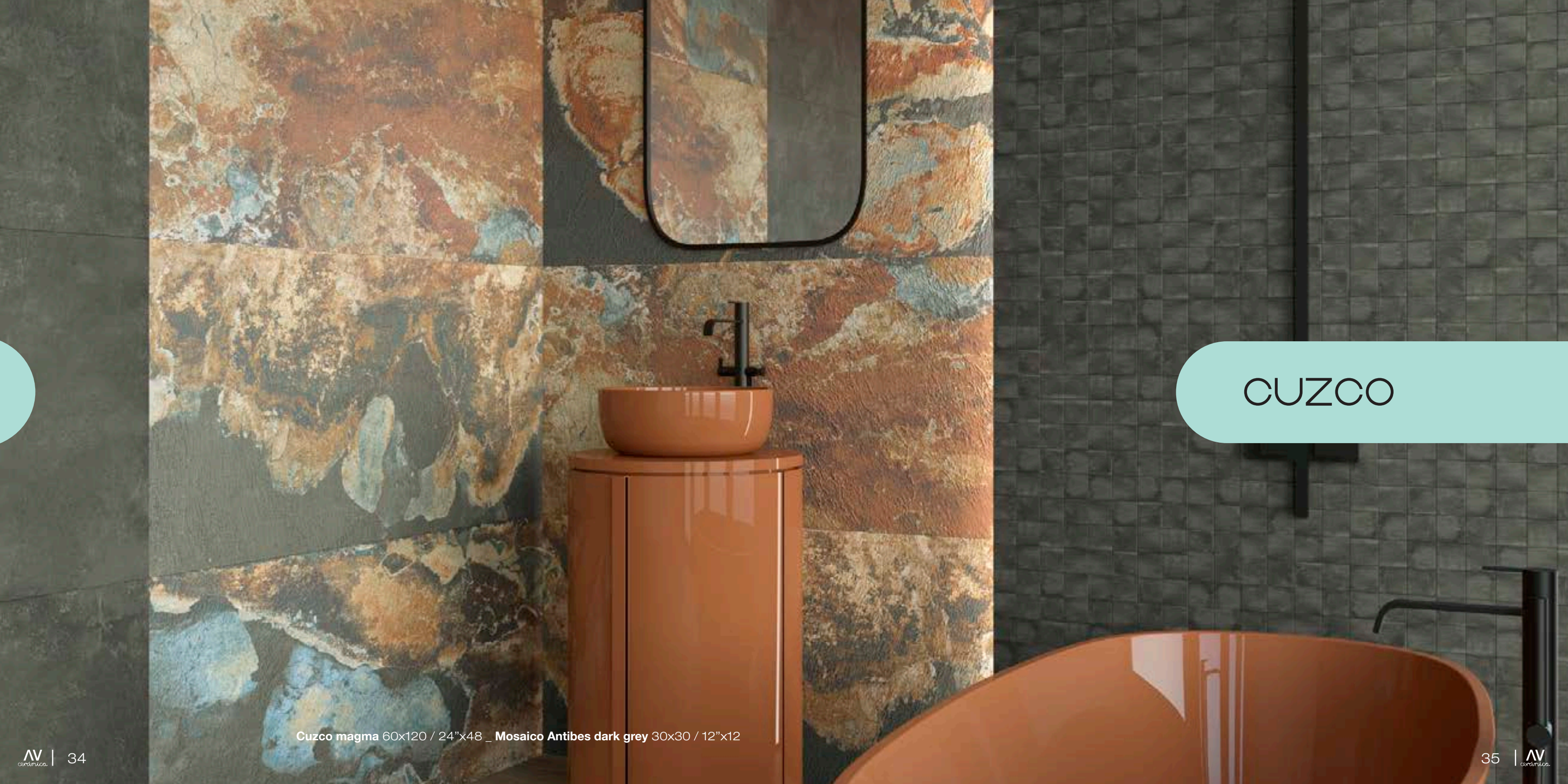

# CUZCO

Cuzco magma 60x120 / 24"x48 \_ Mosaico Antibes dark grey 30x30 / 12"x12





Mate Rectificado /  
Rectified Mat Porcelain /  
Matt Rektifiziert /  
Mat Rectifié /



**Tilos ébano** 20x120 / 8"x48"  
**Cuzco musgo** 60x120 / 24"x48"



# CUZCO

DCOF



pavimento \_ porcelánico \_ rectificado \_ masa coloreada \_ mate  
 floor tile \_ porcelain \_ rectified \_ colored body \_ matt



**Serie susceptible de tratamiento antideslizante bajo demanda.**  
 Series susceptible to anti-slip treatment on request.  
 Série sensible au traitement antidérapant sur demande.  
 Serie mit Antirutschbehandlung auf Anfrage.

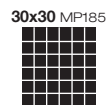

**30x30 MP185 Mosaicos**  
 Mosaics  
 Mosaiques  
 Mosaik

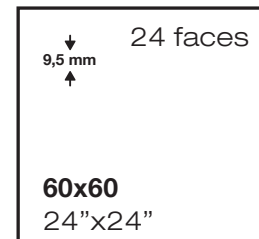
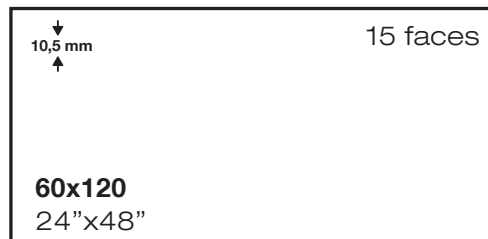
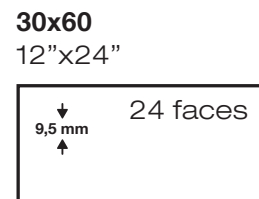
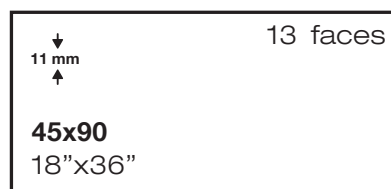

## PACKING & SPECIAL PIECES

	Pc/Cj	M2/Cj	Cj/PI	M2/PI	Kg/Cj	Kg/PI
<b>30x60</b>	6	1,08	48	51,84	23,6	1152,8
<b>60x60</b>	4	1,44	30	43,2	30	920
<b>45x90</b>	3	1,21	44	53,24	28,7	1282,8
<b>60x120</b>	2	1,44	32	46,08	34,5	1124

	Rect.
<b>30x60</b>	MP126
<b>60x60</b>	MP175
<b>45x90</b>	MP300
<b>60x120</b>	MP320

**Ver página 583**  
 See page 583



**Rodapié**  
 Skirting

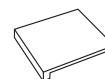

**Peldaño**  
 Step

Cuzco beige 60x60 / 24"x24"



blanco

beige

magma

musgo

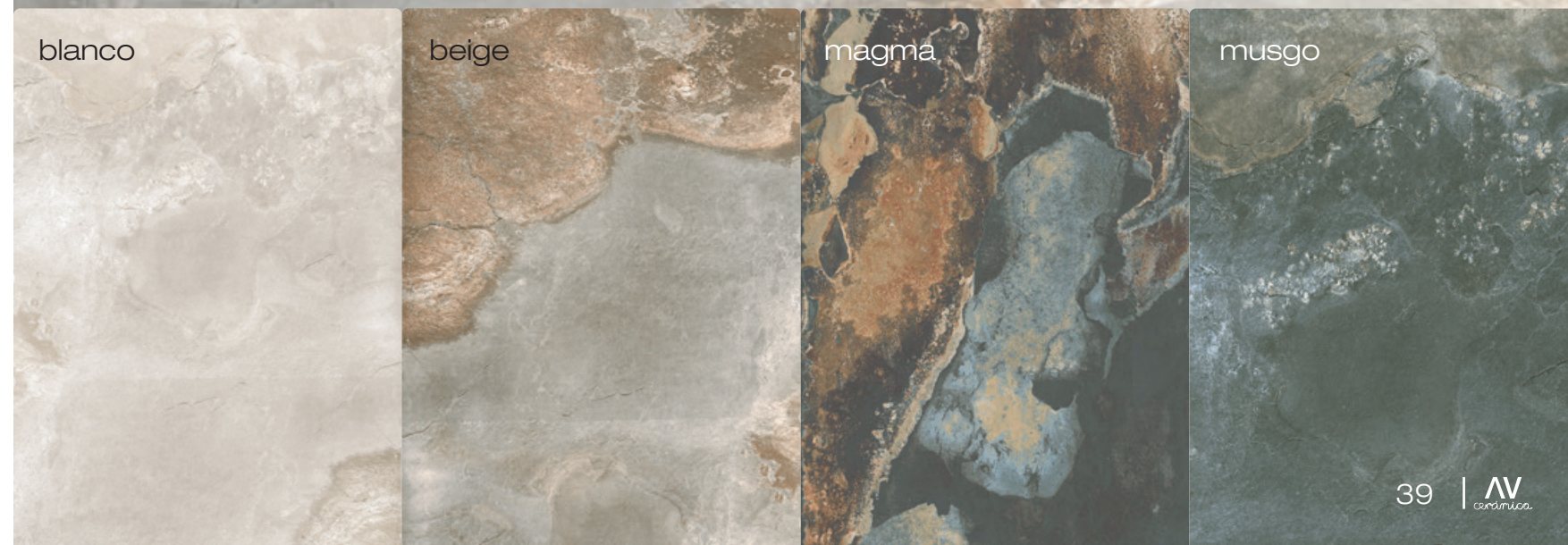





ecchio

Ecchio crema 120x120 / 48"x48"





Mate Rectificado /  
Rectified Mat Porcelain /  
Matt Rektifiziert /  
Mat Rectifié /

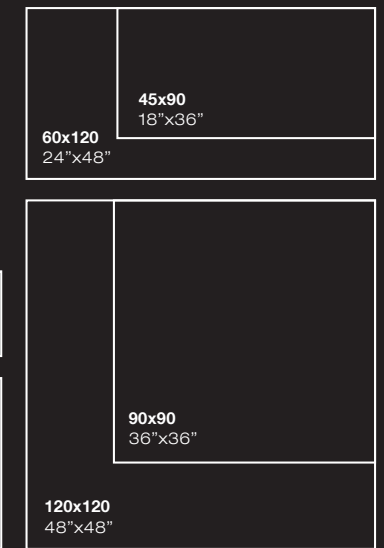

**Ecchio gris 120x120 / 48"x48"**



# ecchio

DCOF



pavimento \_ porcelánico \_ rectificado \_ masa coloreada \_ mate  
 floor tile \_ porcelain \_ rectified \_ colored body \_ matt

 **Serie susceptible de tratamiento antideslizante bajo demanda.**  
 Series susceptible to anti-slip treatment on request.  
 Série sensible au traitement antidérapant sur demande.  
 Serie mit Antirutschbehandlung auf Anfrage.

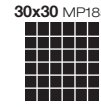
 **30x30 MP185** **Mosaicos**  
 Mosaics  
 Mosaïques  
 Mosaik

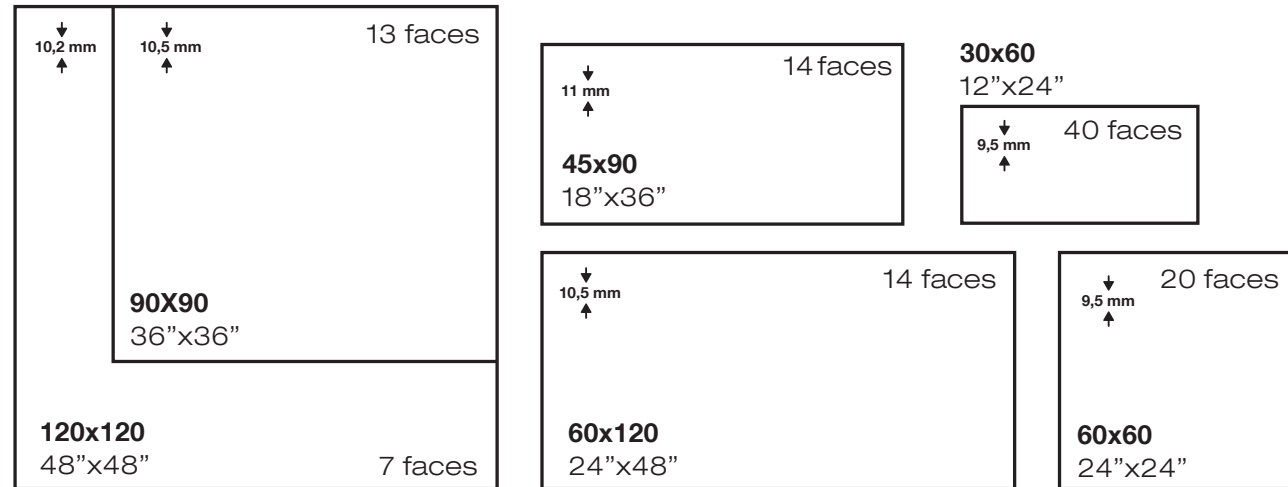

## PACKING & SPECIAL PIECES

	Pc/Cj	M2/Cj	Cj/PI	M2/PI	Kg/Cj	Kg/PI	
<b>30x60</b>	6	1,08	48	51,84	23,6	1152,8	<b>Mate</b>
<b>60x60</b>	4	1,44	30	43,2	30	920	<b>30x60</b> MP182
<b>45x90</b>	3	1,21	44	53,24	28,7	1282,8	<b>60x60</b> MP177
<b>60x120</b>	2	1,44	32	46,08	34,5	1124	<b>45x90</b> MP301
<b>90x90</b>	2	1,62	27	43,74	40	1100	<b>60x120</b> MP325
<b>120x120</b>	1	1,44	36	51,84	36,36	1328,96	<b>90x90</b> MP206
							<b>120x120</b> MP335

 **Ver página 583**  
 See page 583



Ecchio crema 60x120 / 24"x48" \_ Ecchio crema 120x120 / 48"x48" \_ Mosaico Ecchio crema 30x30 / 12"x12"







gerhy

Gerhy aluminio 90x90 / 36"x36" \_ Muretto Gerhy aluminio 17x52 / 7"x21"





Mate Rectificado /

Rectified Mat Porcelain /

Matt Rektifiziert /

Mat Rectifié /

30x60  
12"x24" 

60x60  
24"x24" 

60x120  
24"x48"

90x90  
36"x36"

120x120  
48"x48"

Muretto Gerhy acero 17x52 / 7"x21"

Gerhy acero 30x60 / 12"x24"



# gerhy

DCOF



pavimento \_ porcelánico \_ rectificado \_ masa coloreada \_ mate  
 floor tile \_ porcelain \_ rectified \_ colored body \_ matt

**Serie susceptible de tratamiento antideslizante bajo demanda.**  
 Series susceptible to anti-slip treatment on request.  
 Série sensible au traitement antidérapant sur demande.  
 Serie mit Antirutschbehandlung auf Anfrage.

**30x30 MP185**  
**Mosaicos**  
 Mosaics  
 Mosaïques  
 Mosaik

**Muretto MP103 IN&OUT**  
**17x52 / 7"x21"**

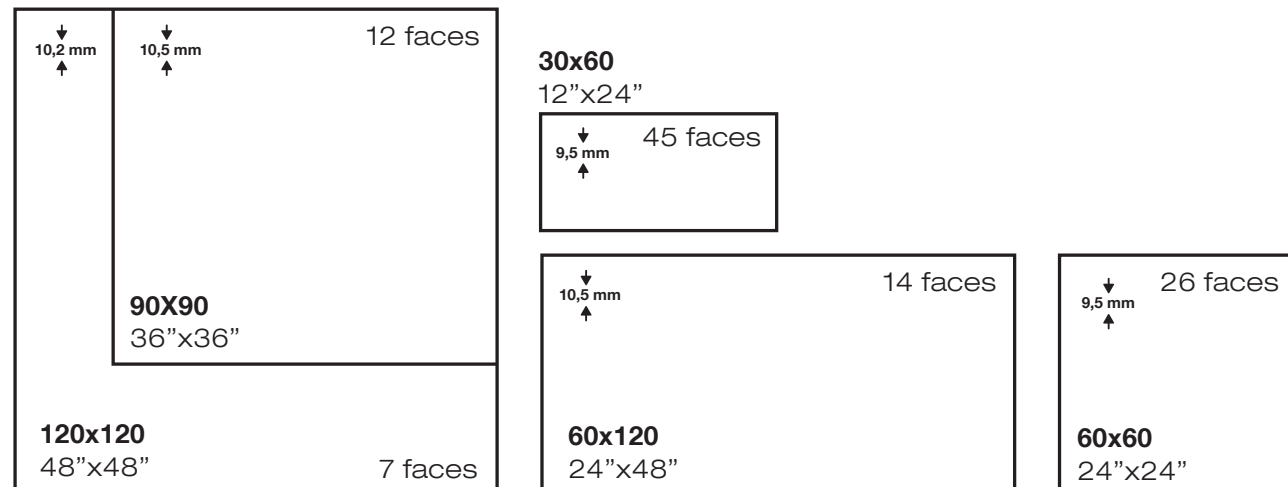

Gerhy plomo 120x120 / 48"x48"

## PACKING & SPECIAL PIECES

	Pc/Cj	M2/Cj	Cj/PI	M2/PI	Kg/Cj	Kg/PI		Mate
<b>30x60</b>	6	1,08	48	51,84	23,6	1152,8	<b>30x60</b>	MP126
<b>60x60</b>	4	1,44	30	43,2	30	920	<b>60x60</b>	MP175
<b>60x120</b>	2	1,44	32	46,08	34,5	1124	<b>60x120</b>	MP320
<b>90x90</b>	2	1,62	27	43,74	40	1100	<b>90x90</b>	MP207
<b>120x120</b>	1	1,44	36	51,84	36,36	1328,96	<b>120x120</b>	MP330

**Ver página 583**  
 See page 583



**Rodapié**  
 Skirting

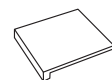

**Peldaño**  
 Step







grain stone

Grain stone black 90x90 / 36"x36" \_ Grain stone black 30x60 / 12"x24" \_ Mosaic Grain stone black 30x30 / 12"x12





Mate Rectificado /

Rectified Mat Porcelain /

Matt Rektifiziert /

Mat Rectifié /

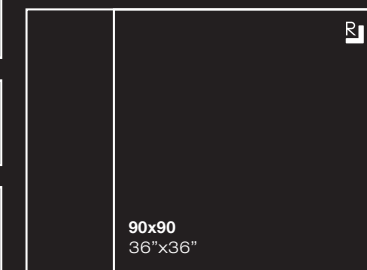
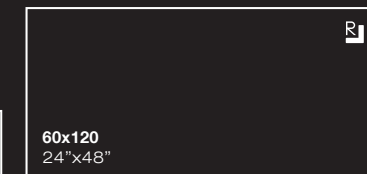
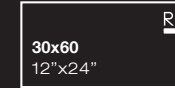

Grain stone silver 90x90 / 36"x36"



# grain stone

DCOF



pavimento \_ porcelánico \_ rectificado \_ masa coloreada \_ mate  
 floor tile \_ porcelain \_ rectified \_ colored body \_ matt

Serie susceptible de tratamiento antideslizante bajo demanda excepto en 45x45.  
 Series susceptible to anti-slip treatment on request except in 45x45.  
 Série sensible au traitement antidérapant sur demande sauf en 45x45..  
 Serie mit Antirutschbehandlung auf Anfrage außer in 45x45.

30x30 MP185 **Mosaicos**  
 Mosaics  
 Mosaïques  
 Mosaik

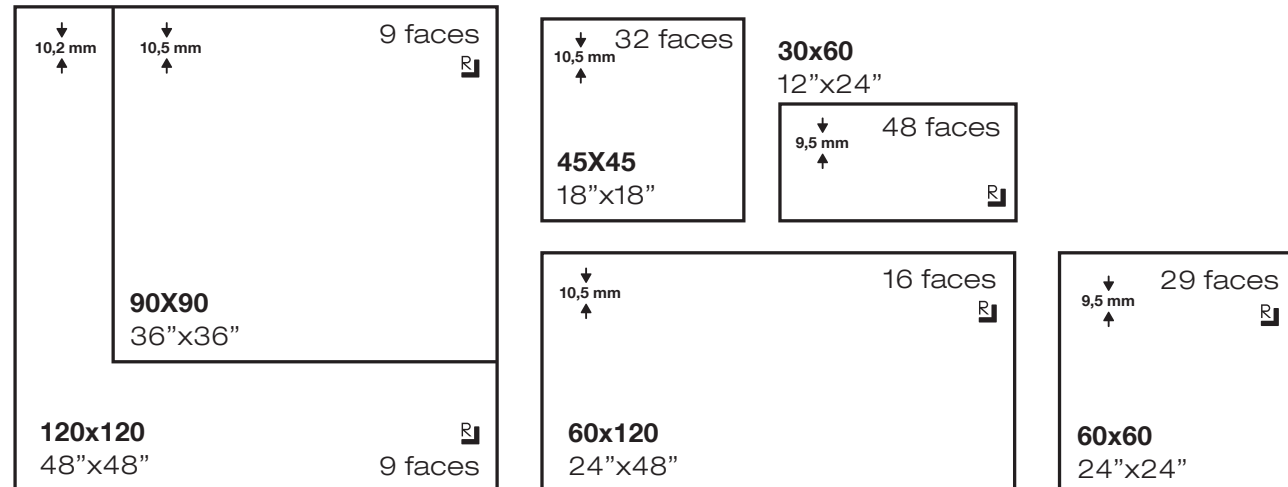

## PACKING & SPECIAL PIECES

	Pc/Cj	M2/Cj	Cj/PI	M2/PI	Kg/Cj	Kg/PI
30x60	6	1,08	48	51,84	23,6	1152,8
45x45	6	1,22	52	63,44	25,8	1361,6
60x60	4	1,44	30	43,2	30	920
60x120	2	1,44	32	46,08	34,5	1124
90x90	2	1,62	27	43,74	40	1100
120x120	1	1,44	36	51,84	36,36	1328,96

	Rect. Mate	Mate
30x60	MP126	-
45x45	-	MP136
60x60	MP175	-
60x120	MP320	-
90x90	MP207	-
120x120	MP330	-

Ver página 583  
 See page 583



Rodapié  
 Skirting

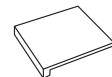

Peldaño  
 Step

Grain stone sand 120x120 / 48"x48"



sand

pearl

silver

black





inka

Inka grey 60x60 / 24"x24" \_ Mosaico Inka grey 30x30 / 12"x24"





Mate Rectificado /

Rectified Mat Porcelain /

Matt Rektifiziert /

Mat Rectifié /

60x60  
24"x24"

30x60  
12"x24"

Floor \_ **Inka white** 60x60 / 24"x24"

Wall \_ **Inka white** 60x60 / 24"x24"

Wall \_ **Rlv tahoe white** 30x60 / 12"x24"



# inka

DCOF 



pavimento \_ porcelánico \_ rectificado \_ masa coloreada \_ mate  
 floor tile \_ porcelain \_ rectified \_ colored body \_ matt



**El Dc Jersey únicamente se suministra en formato 30x60**  
 Dc Jersey is only available in size 30x60.  
 Dc Jersey est uniquement disponible en format 30x60.  
 Das Dc Jersey wird nur im Format 30x60 geliefert.

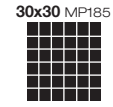

**Mosaicos**  
 Mosaics  
 Mosaiques  
 Mosaik



**Serie susceptible de tratamiento antideslizante bajo demanda.**  
 Series susceptible to anti-slip treatment on request.  
 Série sensible au traitement antidérapant sur demande.  
 Serie mit Antirutschbehandlung auf Anfrage.

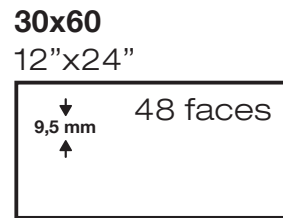
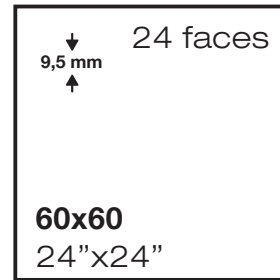

## PACKING & SPECIAL PIECES

	Pc/Cj	M2/Cj	Cj/PI	M2/PI	Kg/Cj	Kg/PI
<b>30x60</b>	6	1,08	48	51,84	23,6	1152,8
<b>60x60</b>	4	1,44	30	43,2	30	920

	Mate
<b>30x60</b>	MP126
<b>60x60</b>	MP175
<b>30X60 Dc Jersey</b>	MP127
<b>30X60 Rlv Tahoe</b>	MP126
<b>60X60 Rlv Tahoe</b>	MP170

 **Ver página 583**  
 See page 583

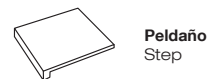

Rlv tahoe white 30x60 / 12"x24"

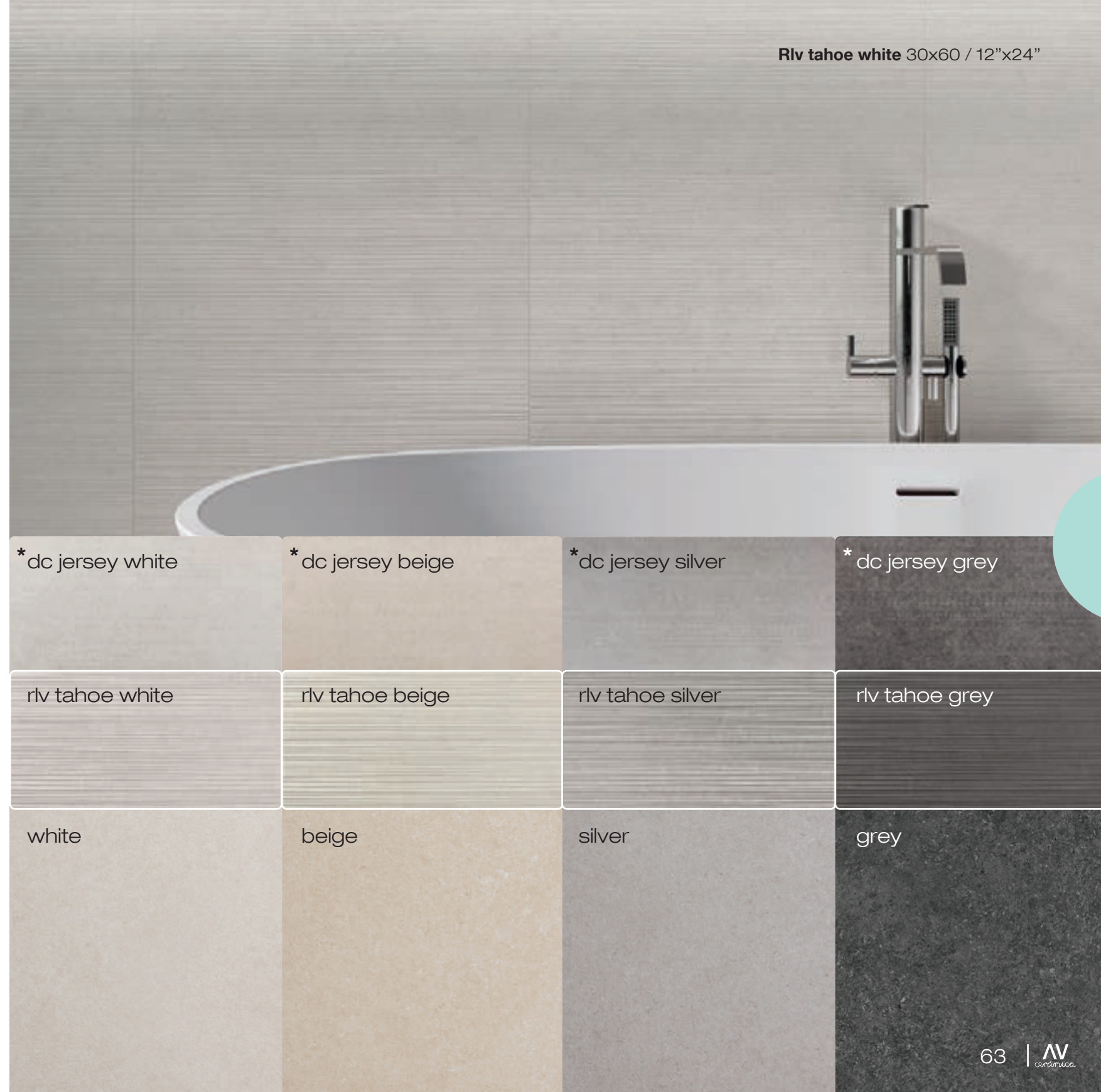

* dc jersey white	* dc jersey beige	* dc jersey silver	* dc jersey grey
rlv tahoe white	rlv tahoe beige	rlv tahoe silver	rlv tahoe grey
white	beige	silver	grey





method

Method white mate 75x150 / 30"x60" \_ Method antracita mate 75x150 / 30"x60" \_ Mauka roble 23x120 / 10"x48"



# antibacteriano

antibacterial / antibactérien / antibakteriell

**La gran mayoría de bacterias son inocuas para la salud, no obstante, existen algunas dañinas que se pueden propagar en las superficies generando desde malos olores hasta posibles dolencias. Por esta razón, resulta imprescindible llevar a cabo procesos de limpieza exhaustivos, sobretudo en zonas comunes de uso corriente. En respuesta a esta necesidad, se ha desarrollado la serie Method, que, gracias al uso de iones de plata integrados en la masa cerámica, mejora la higiene en la superficie de la misma. En este sentido, también ofrece un valor añadido de protección para los usos más intensos.**

## Beneficios )

**/ Impedimento del desarrollo de microorganismos, por lo que nos protege contra todo tipo de bacterias.**

**/ La eficiencia antimicrobiana se ha determinado según la norma JIS 2801 y el ensayo para la protección antivírica ISO 21702.**

**/ Zonas limpias durante más tiempo, y más fáciles de higienizar debido a sus propiedades antibacterianas.**

**/ Material recomendado para todo tipo de usos y zonas.**

The vast majority of bacteria are harmless to health, however, there are some harmful ones that can spread on surfaces generating from bad odors to possible diseases. For this reason, it is essential to carry out exhaustive cleaning processes, especially in areas of common use. In response to this need, we have developed the Method collection, which, thanks to the use of silver ions integrated in the ceramic body, improves hygiene on the tile surface. In this sense, it also offers an extra protection for the most intense uses.

## Benefits )

/ Impediment of the development of microorganisms, so it protects us against all types of bacteria.

/ The antimicrobial efficiency has been determined according to the JIS 2801 standard and the ISO 21702 antiviral protection test.

/ Clean areas for longer, and easier to sanitize due to its antibacterial properties.

/ Recommended material for all types of uses and areas.

La grande majorité des bactéries sont inoffensives pour la santé, cependant, certaines sont nocives qui peuvent se propager sur les surfaces, générant de mauvaises odeurs au possible maux. Pour cette raison, il est essentiel d'effectuer des processus de nettoyage exhaustifs, en particulier dans les zones communes d'usage courant. En réponse à ce besoin, a développé la série Method qui, grâce à l'utilisation d'ions argent intégrés dans la masse céramique, améliore l'hygiène de la surface céramique. En ce sens, aussi offre une valeur de protection supplémentaire pour les utilisations les plus intenses.

## Avantages )

/ Empêchement du développement des microorganismes, il nous protège donc contre tous les types de bactéries.

/ L'efficacité antimicrobienne a été déterminée selon la norme JIS 2801 et le test de protection antivirale ISO 21702.

/ Nettoyer les zones plus longtemps et plus facilement désinfecter grâce à ses propriétés antibactériennes.

/ Matériel recommandé pour tous types d'utilisations et zones.

Die überwiegende Mehrheit der Bakterien ist gesundheitlich unbedenklich, jedoch gibt es einige schädliche Bakterien, die sich auf Oberflächen ausbreiten können und von schlechten Gerüchen bis hin zu möglichen Krankheiten führen. Aus diesem Grund ist eine gründliche Reinigung, insbesondere in den Gemeinschaftsbereichen des täglichen Gebrauchs, unerlässlich. Als Antwort auf dieses Bedürfnis wurde die Method-Serie entwickelt, die durch den Einsatz von Silberionen, die in die Keramikmasse integriert sind, die Hygiene der Keramikoberfläche verbessert. In dieser Hinsicht ist es auch Mehrwert in Bezug auf den Schutz für die intensivste Nutzung.

## Leistungen )

/ Beeinträchtigung der Entwicklung von Mikroorganismen, dadurch Schutz vor allen Arten von Bakterien.

/ Die antimikrobielle Wirksamkeit wurde gemäß der Norm JIS 2801 und dem Test für antiviralen Schutz nach ISO 21702 bestimmt.

/ Flächen bleiben länger sauber und lassen sich aufgrund der antibakteriellen Eigenschaften leichter desinfizieren.

/ Material empfohlen für alle Arten von Anwendungen und Bereichen.





Mate Rectificado /

Rectified Mat Porcelain /

Matt Rektifiziert /

Mat Rectifié /

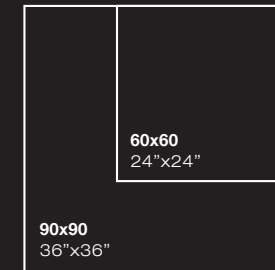
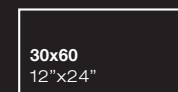
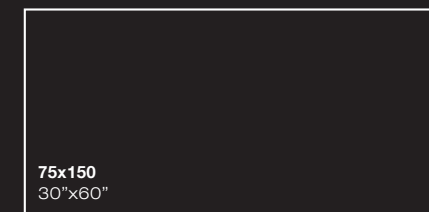

**90x90**  
36"x36"

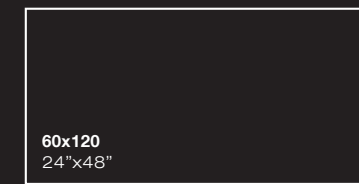
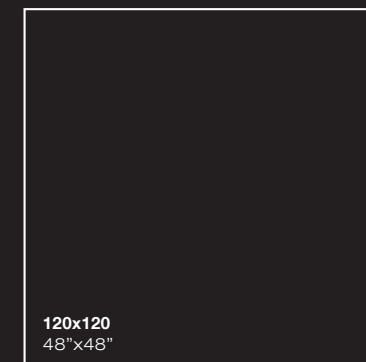

Method silver 90x90 / 36"x36"



# method

DCOF



pavimento \_ porcelánico \_ rectificado \_ masa coloreada \_ mate \_ lappato  
 floor tile \_ porcelain \_ rectified \_ colored body \_ matt \_ lappato

 **Serie susceptible de tratamiento antideslizante bajo demanda.**  
 Series susceptible to anti-slip treatment on request.  
 Série sensible au traitement antidérapant sur demande.  
 Serie mit Antirutschbehandlung auf Anfrage.

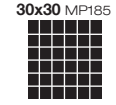
 **30x30 MP185 Mosaicos**  
 Mosaics  
 Mosaïques  
 Mosaik

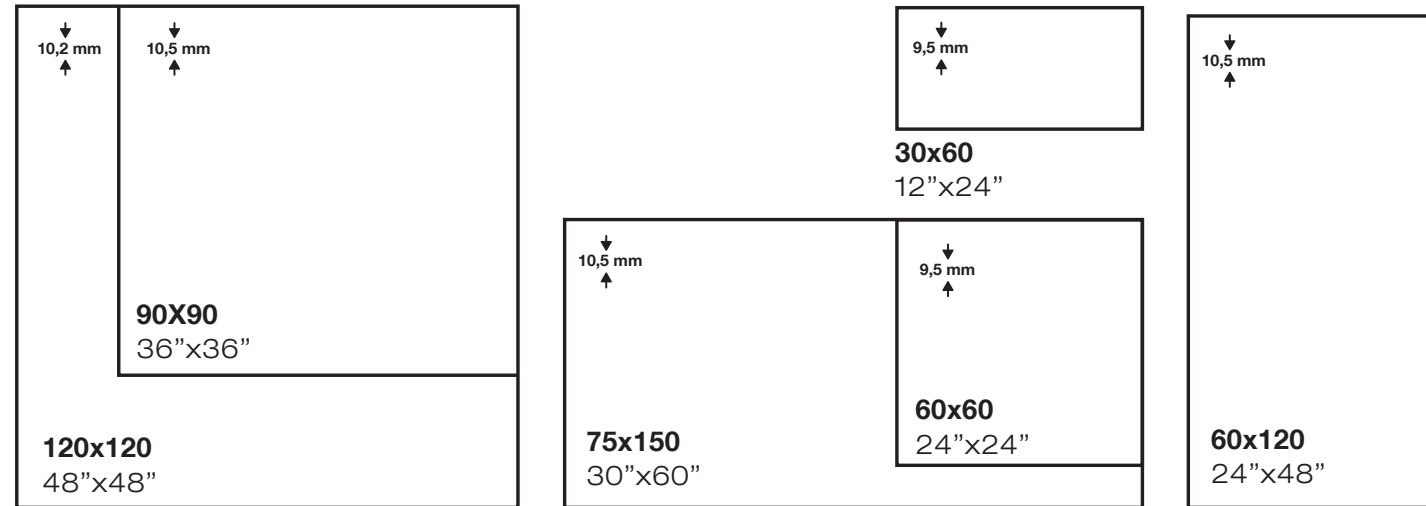

Peldaño Method bone 30x120 / 12"x48"

## PACKING & SPECIAL PIECES

	Pc/Cj	M2/Cj	Cj/PI	M2/PI	Kg/Cj	Kg/PI
<b>30x60</b>	7	1,26	40	50,4	24,1	984
<b>60x60</b>	4	1,44	30	43,2	30	920
<b>60x120</b>	2	1,44	32	46,08	34,5	1124
<b>90x90</b>	2	1,62	27	43,74	40	1100
<b>120x120</b>	1	1,44	36	51,84	38,4	1402,4
<b>120x120</b>	1	1,44	36	51,84	36,36	1328,96

	Mate	Lappato
<b>30x60</b>	MP126	MP123
<b>60x60</b>	MP175	MP172
<b>60x120</b>	MP320	MP321
<b>90x90</b>	MP207	MP203
<b>120x120</b>	MP330	MP331
<b>75x150</b>	MP340	MP344

 **Ver página 583**  
 See page 583



**Rodapié**  
 Skirting



**Peldaño**  
 Step

white

bone

mud

silver

antracita





petrae

Method white mate 75x150 / 30"x60" \_ Method antracita mate 75x150 / 30"x60" \_ Mauka roble 23x120 / 10"x48"





Mate Rectificado /

Rectified Mat Porcelain /

Matt Rektifiziert /

Mat Rectifié /

30x60  
12"x24"

60x60  
24"x24"

90x90  
36"x36"

120x120  
48"x48"

60x120  
24"x48"

Mosaico Petrae natural 30x30 / 12"x12"

Petrae natural 30x60 / 12"x24"

Petrae natural 60x60 / 24"x24"



# petrae

DCOF



pavimento \_ porcelánico \_ rectificado \_ masa coloreada \_ mate  
 floor tile \_ porcelain \_ rectified \_ colored body \_ matt



**Serie susceptible de tratamiento antideslizante bajo demanda.**  
 Series susceptible to anti-slip treatment on request.  
 Série sensible au traitement antidérapant sur demande.  
 Serie mit Antirutschbehandlung auf Anfrage.

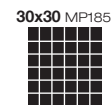

**Mosaicos**  
 Mosaics  
 Mosaïques  
 Mosaik

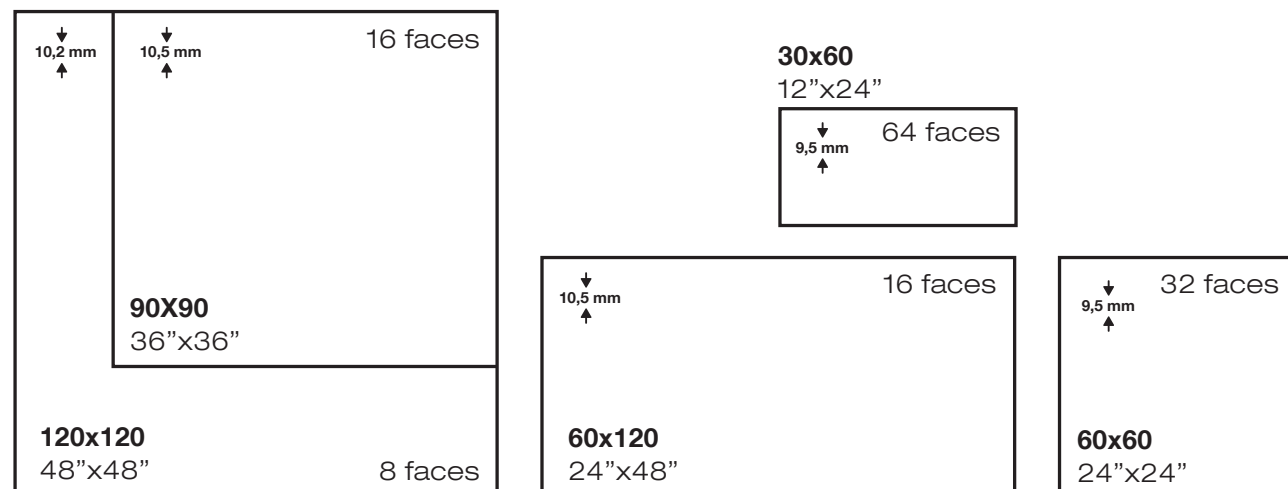

## PACKING & SPECIAL PIECES

	Pc/Cj	M2/Cj	Cj/PI	M2/PI	Kg/Cj	Kg/PI
<b>30x60</b>	6	1,08	48	51,84	23,6	1152,8
<b>60x60</b>	4	1,44	30	43,2	30	920
<b>60x120</b>	2	1,44	32	46,08	34,5	1124
<b>90x90</b>	2	1,62	27	43,74	40	1100
<b>120x120</b>	1	1,44	36	51,84	36,36	1328,96

	Mate
<b>30x60</b>	MP126
<b>60x60</b>	MP175
<b>60x120</b>	MP320
<b>90x90</b>	MP207
<b>120x120</b>	MP330

**Ver página 583**  
 See page 583



**Rodapié**  
 Skirting



**Peldaño**  
 Step







street

Street dark 120x120 / 48"x48" \_ Street silver 60x120 / 24"x48"





Mate Rectificado /

Rectified Mat Porcelain /

Matt Rektifiziert /

Mat Rectifié /

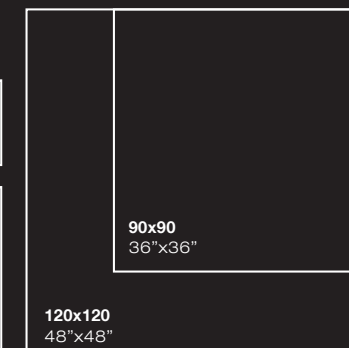
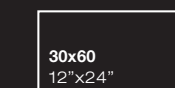
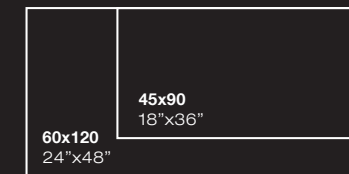

Street beige 45x90 / 18"x36"



# street

DCOF



pavimento \_ porcelánico \_ rectificado \_ masa coloreada \_ mate  
 floor tile \_ porcelain \_ rectified \_ colored body \_ matt



**Serie susceptible de tratamiento antideslizante bajo demanda.**  
 Series susceptible to anti-slip treatment on request.  
 Série sensible au traitement antidérapant sur demande.  
 Serie mit Antirutschbehandlung auf Anfrage.

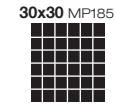

**Mosaicos**  
 Mosaics  
 Mosaïques  
 Mosaik

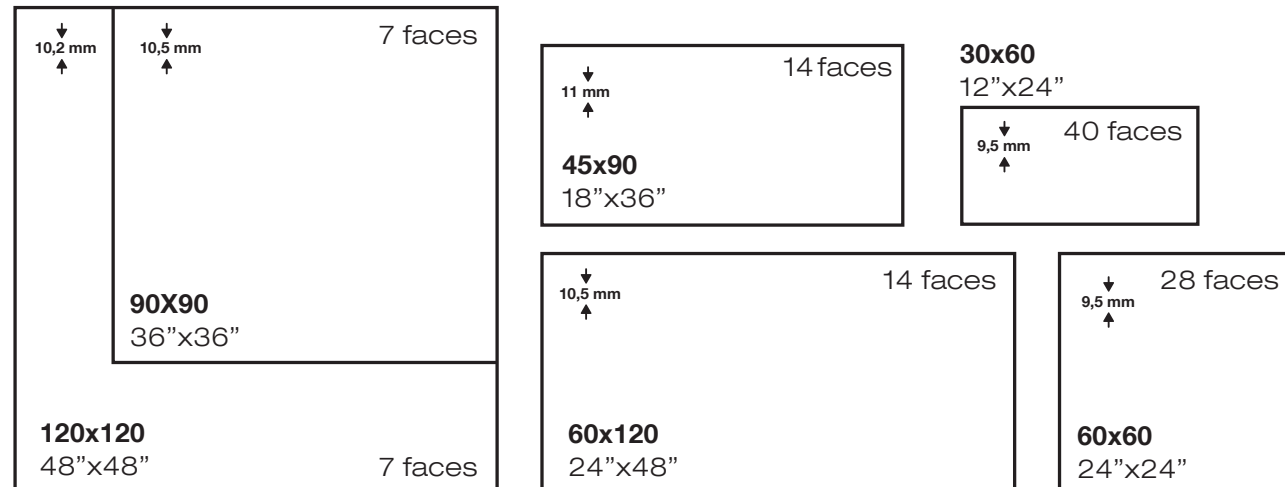

## PACKING & SPECIAL PIECES

	Pc/Cj	M2/Cj	Cj/Pl	M2/Pl	Kg/Cj	Kg/Pl
<b>30x60</b>	6	1,08	48	51,84	23,6	1152,8
<b>45x90</b>	3	1,21	44	53,24	28,7	1282,8
<b>60x60</b>	4	1,44	30	43,2	30	920
<b>60x120</b>	2	1,44	32	46,08	34,5	1124
<b>90x90</b>	2	1,62	27	43,74	40	1100
<b>120x120</b>	1	1,44	36	51,84	36,36	1328,96

	Rect. Mate
<b>30x60</b>	MP182
<b>45x90</b>	MP301
<b>60x60</b>	MP177
<b>60x120</b>	MP325
<b>90x90</b>	MP206
<b>120x120</b>	MP335

**Ver página 583**  
 See page 583



**Rodapié**  
 Skirting

**Peldaño**  
 Step



Street dark 45x90 / 18"x36" \_ Street silver 45x90 / 18"x36"

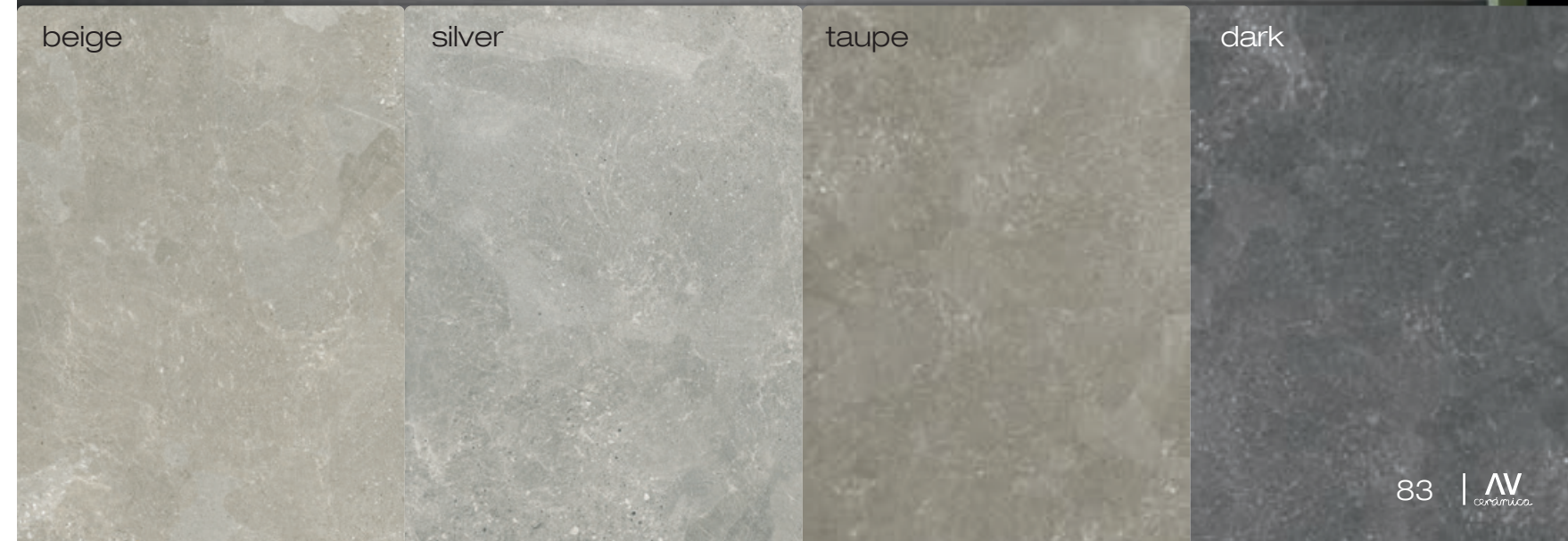

beige

silver

taupe

dark





valdivia

Valdivia gris 120x120 / 48"x48"





Mate Rectificado /

Rectified Mat Porcelain /

Matt Rektifiziert /

Mat Rectifié /

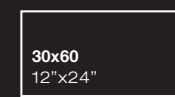

Mosaico Valdivia gris 30x30 / 12"x12"

Valdivia gris 60x120 / 24"x48"



# Valdivia

DCOF



pavimento \_ porcelánico \_ rectificado \_ masa coloreada \_ mate  
 floor tile \_ porcelain \_ rectified \_ colored body \_ matt

**Serie susceptible de tratamiento antideslizante bajo demanda.**  
 Series susceptible to anti-slip treatment on request.  
 Série sensible au traitement antidérapant sur demande.  
 Serie mit Antirutschbehandlung auf Anfrage.

**30x30 MP185 Mosaicos**  
 Mosaics  
 Mosaïques  
 Mosaik

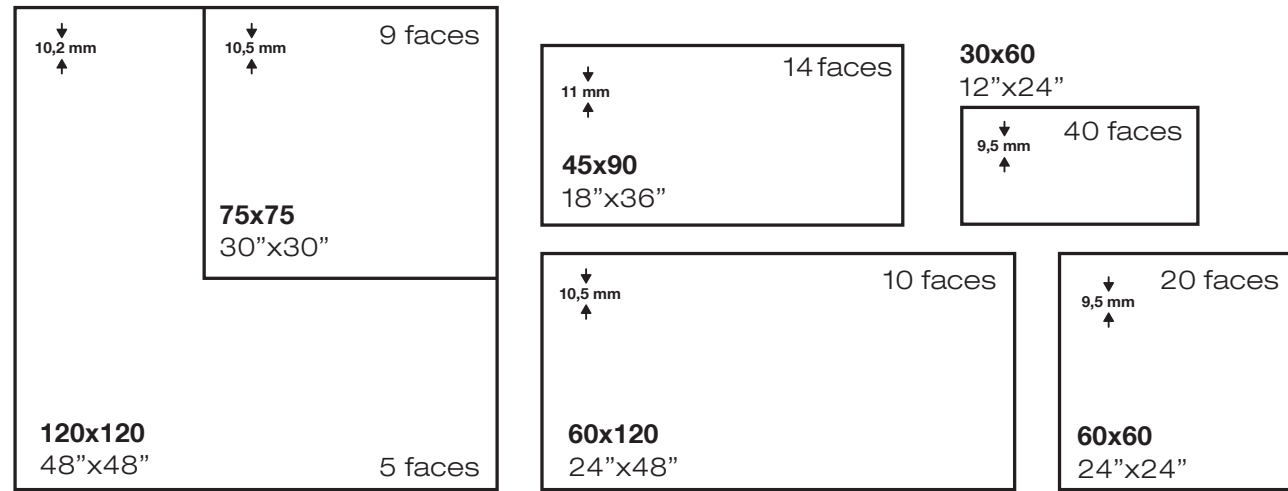

## PACKING & SPECIAL PIECES

	Pc/Cj	M2/Cj	Cj/PI	M2/PI	Kg/Cj	Kg/PI
<b>30x60</b>	6	1,08	48	51,84	23,6	1152,8
<b>45x90</b>	3	1,21	44	53,24	28,7	1282,8
<b>60x60</b>	4	1,44	30	43,2	30	920
<b>60x120</b>	2	1,44	32	46,08	34,5	1124
<b>75x75</b>	3	1,69	30	50,7	41,2	1256
<b>120x120</b>	1	1,44	36	51,84	36,36	1328,96

	Rect. Mate
<b>30x60</b>	MP126
<b>45x90</b>	MP300
<b>60x60</b>	MP175
<b>60x120</b>	MP320
<b>75x75</b>	MP193
<b>120x120</b>	MP330

**Ver página 583**  
 See page 583



**Rodapié**  
 Skirting

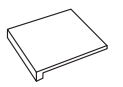

**Peldaño**  
 Step

Valdivia crema 60x60 / 24"x24" \_ Valdivia crema 30x60 / 12"x24" \_ Mosaico Valdivia crema 30x30 / 12"x12"







ziro

Ziro gris 120x120 / 48"x48"





Mate Rectificado /

Rectified Mat Porcelain /

Matt Rektifiziert /

Mat Rectifié /

**60x120**  
24"x48"

  
**45x45**  
18"x18"

**120x120**  
48"x48"

**75x75**  
30"x30"

  
**30x60**  
12"x24"

  
**60x60**  
24"x24"

  
**90x90**  
36"x36"

**Mosaico Ziro blanco 30x30 / 12"x12"**

**Ziro blanco 90x90 / 36"x36"**



# ziro

DCOF



pavimento \_ porcelánico \_ rectificado \_ masa coloreada \_ mate \_ lappato  
 floor tile \_ porcelain \_ rectified \_ colored body \_ matt \_ lappato



**Mosaicos**  
 Mosaics  
 Mosaïques  
 Mosaik



Los tamaños 30x60 y 60x60 se puede suministrar antideslizantes.  
 30x60 and 60x60 sizes from collection can be produced on antislip finish.  
 Les tailles 30x60 et 60x60 peuvent être fournies antidérapantes.  
 Die Größen 30x60 und 60x60 können rutschfest geliefert werden.



Serie susceptible de tratamiento antideslizante bajo demanda excepto en 45x45.  
 Series susceptible to anti-slip treatment on request except in 45x45.  
 Série sensible au traitement antidérapant sur demande sauf en 45x45.  
 Serie mit Antirutschbehandlung auf Anfrage außer in 45x45.

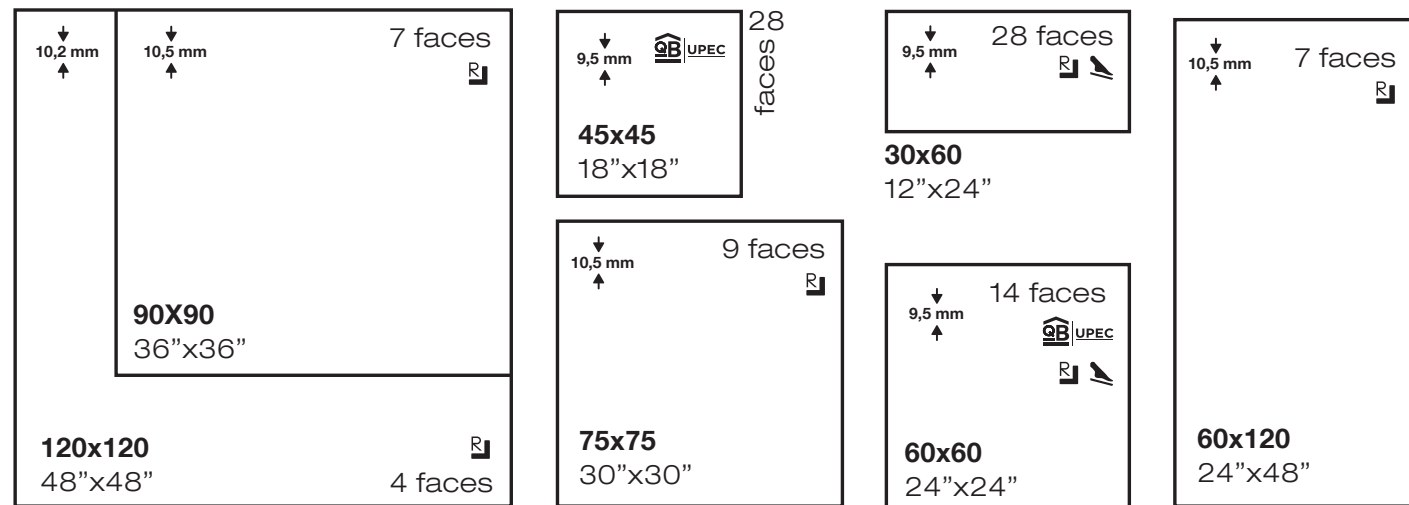

## PACKING & SPECIAL PIECES

	Pc/Cj	M2/Cj	Cj/Pl	M2/Pl	Kg/Cj	Kg/Pl
30x60	7	1,26	40	50,4	24,1	984
45x45	6	1,22	52	63,44	25,8	1361,6
60x60	4	1,44	30	43,2	30	920
60x120	2	1,44	32	46,08	34,5	1124
75x75	3	1,69	30	50,7	41,2	1256
90x90	2	1,62	27	43,74	40	1100
120x120	1	1,44	36	51,84	36,36	1328,96

	Mate Rect.	ADZ	Lappato	Mate
30x60	MP126	MP125	MP123	-
45x45	-	-	-	MP136
60x60	MP175	MP173	MP172	-
60x120	MP320	-	MP321	-
75x75	MP193	-	MP191	-
90x90	MP207	-	MP203	-
120x120	MP330	-	MP331	-

Ver página 583  
 See page 583



Rodapié  
 Skirting

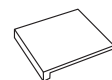

Peldaño  
 Step



Ziro crema 60x60 / 24"x24"

blanco

crema

perla

gris

marengo





20mm

thickness

## DE

Geschaffen mit der Philosophie der globalen Dekoration zwischen Innen und Außen.

## FR

Créé avec la philosophie de la décoration globale entre l'intérieur et l'extérieur.

## EN

Based on the philosophy to merge pleasantly indoors and outdoors.

## ES

Creados con la filosofía de decoración global entre el interior y el exterior.

antibes • elder • grain stone • belgravia • cotto • ecchio • piazza • street





antibes

Antibes dark grey 60,5x60,5 / 24"x24"



# antibes



pavimento adz \_ porcelánico \_ rectificado \_ masa coloreada \_ mate  
 adz floor tile \_ porcelain \_ rectified \_ colored body \_ matt

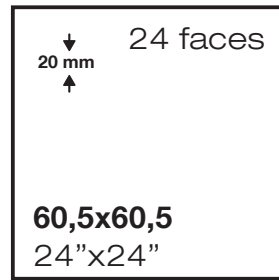

## PACKING & SPECIAL PIECES

	Pc/Cj	M2/Cj	Cj/PI	M2/PI	Kg/Cj	Kg/PI	
60,5x60,5	2	0,73	30	21,9	34	1040	Rect. 20mm
							60,5x60,5 MP510

 **Ver página 574**  
See page 574

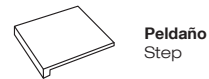

Antibes ivory 60,5x60,5 / 24"x24" \_ Antibes ivory 45x90 / 18"x36"



ivory

pearl

grey

dark grey





elder

Elder taupe 90x90 / 36"x36"



# elder



pavimento adz \_ porcelánico \_ rectificado \_ masa coloreada \_ mate  
 adz floor tile \_ porcelain \_ rectified \_ colored body \_ matt

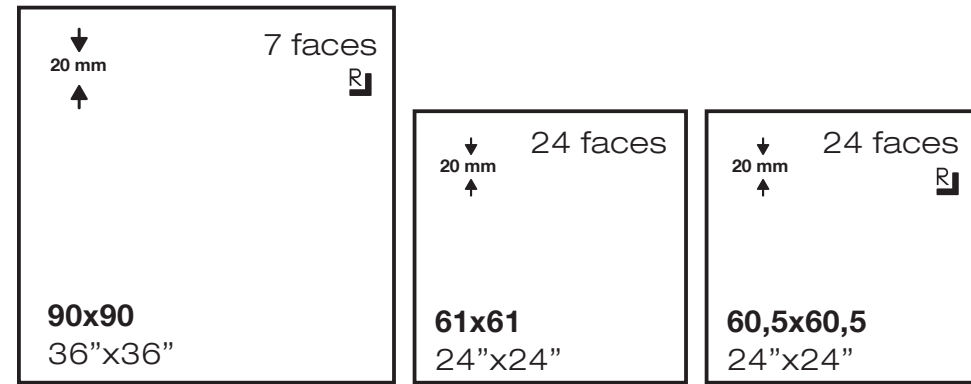

## PACKING & SPECIAL PIECES

	Pc/Cj	M2/Cj	Cj/PI	M2/PI	Kg/Cj	Kg/PI
<b>60,5x60,5</b>	2	0,73	30	21,9	34	1040
<b>61x61</b>	2	0,74	30	22,2	33	1010
<b>90x90</b>	1	0,81	27	21,87	38,8	1067,6

	Rect. 20mm	20 mm
<b>60,5x60,5</b>	MP510	-
<b>61x61</b>	-	MP500
<b>90x90</b>	MP550	-

**Ver página 574**  
See page 574



**Rodapié**  
Skirting

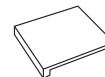

**Peldaño**  
Step

Elder gris 90x90 / 36"x36"



taupe

gris





grain stone

Grain Stone sand 90x90 / 36"x36"



# grain stone



pavimento adz \_ porcelánico \_ rectificado \_ masa coloreada \_ mate  
adz floor tile \_ porcelain \_ rectified \_ colored body \_ matt

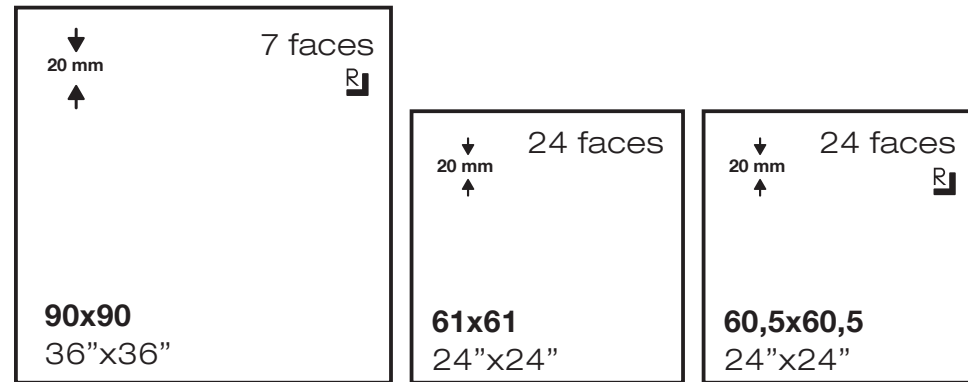

## PACKING & SPECIAL PIECES

	Pc/Cj	M2/Cj	Cj/PI	M2/PI	Kg/Cj	Kg/PI
<b>60,5x60,5</b>	2	0,73	30	21,9	34	1040
<b>61x61</b>	2	0,74	30	22,2	33	1010
<b>90x90</b>	1	0,81	27	21,87	38,8	1067,6

	Rect. 20mm	20 mm
<b>60,5x60,5</b>	MP510	-
<b>61x61</b>	-	MP500
<b>90x90</b>	MP550	-

 **Ver página 574**  
See page 574



**Rodapié**  
Skirting

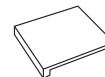

**Peldaño**  
Step

Grain Stone sand 90x90 / 36"x36"



sand

pearl







belgravia

Belgravia Tex grey 20x30 / 8"x12"



**BELGRAVIA TEX GREY / LINE GREY**



**BELGRAVIA TEX ANTHRACITE / LINE ANTHRACITE**



**BELGRAVIA TEX PEARL / LINE PEARL**

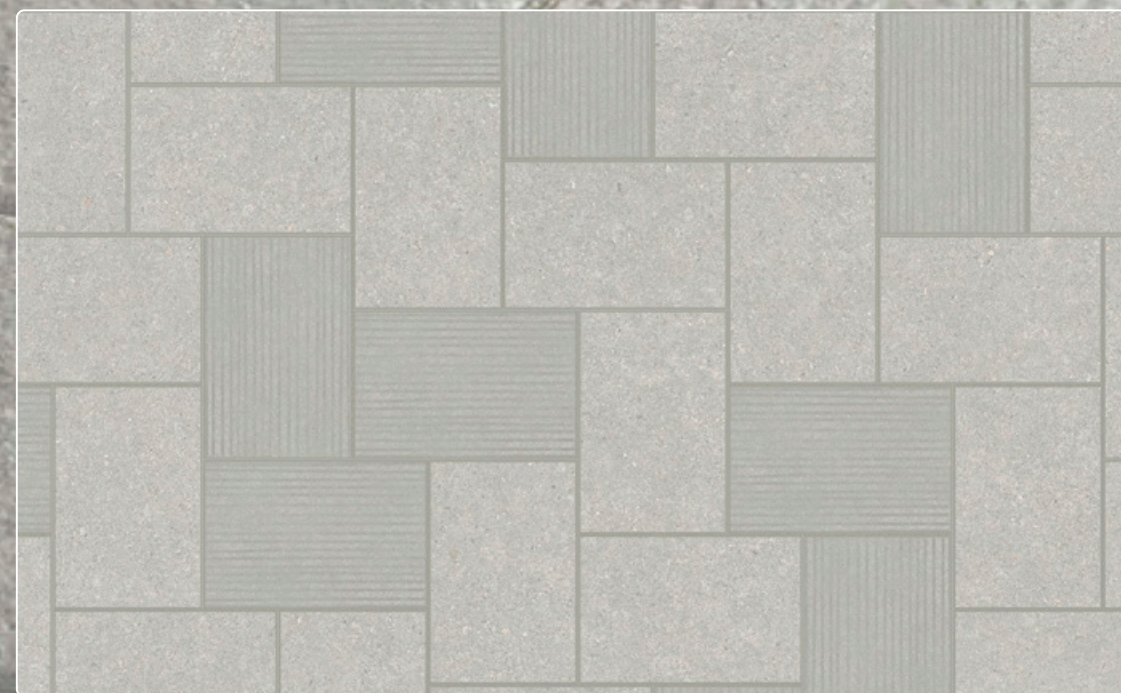



# belgravia



pavimento adz \_ porcelánico \_ masa coloreada \_ mate \_ no rectificado  
 adz floor tile \_ porcelain \_ colored body \_ matt \_ non rectified

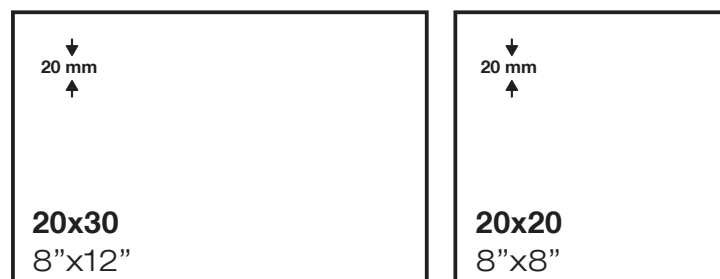

## PACKING & SPECIAL PIECES

	Pc/Cj	M2/Cj	Cj/PI	M2/PI	Kg/Cj	Kg/PI
<b>20x20</b>	12	0,48	60	28,8	22,30	1358
<b>20x30</b>	8	0,48	64	30,72	22,30	1447

	20mm
<b>20x20</b>	MP186
<b>20x30</b>	MP183

Ver página 576  
See page 576



Rodapié  
Skirting

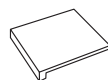

Peldaño  
Step

Belgravia Tex anthracite 20x20 / 8"x8" \_ Belgravia Line anthracite 20x30 / 8"x12"



line pearl

line grey

line anthracite

tex pearl

tex grey

tex anthracite





cotto

Cotto cotto 20x30 / 8"x12"



COTTO COTTO 20X30 / 8X12"



COTTO GRIS 20X20 / 8X8" \_ 20X30 / 8X12"





# cotto



pavimento adz \_ porcelánico \_ masa coloreada \_ mate \_ no rectificado  
 adz floor tile \_ porcelain \_ colored body \_ matt \_ non rectified



## PACKING & SPECIAL PIECES

	Pc/Cj	M2/Cj	Cj/PI	M2/PI	Kg/Cj	Kg/PI
<b>20x20</b>	12	0,48	60	28,8	22,30	1358
<b>20x30</b>	8	0,48	64	30,72	22,30	1447

	20mm
<b>20x20</b>	MP186
<b>20x30</b>	MP183

**Ver página 576**  
See page 576



**Rodapié**  
Skirting



**Peldaño**  
Step

Cotto gris 20x20 / 8"x8" \_ 20x30 / 8"x12"



cotto

gris





ecchio

Ecchio perla 20x30 / 8"x12"



**ECCHIO PERLA 20X20 / 8X8"**



**ECCHIO CREMA 20X20 / 8X8" \_ 20X30 / 8X12"**



**ECCHIO GRIS 20X20 / 8X8"**





# ecchio



pavimento adz \_ porcelánico \_ masa coloreada \_ mate \_ no rectificado  
 adz floor tile \_ porcelain \_ colored body \_ matt \_ non rectified

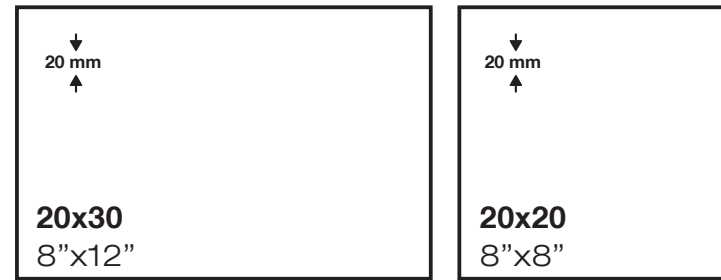

## PACKING & SPECIAL PIECES

	Pc/Cj	M2/Cj	Cj/PI	M2/PI	Kg/Cj	Kg/PI
<b>20x20</b>	12	0,48	60	28,8	22,30	1358
<b>20x30</b>	8	0,48	64	30,72	22,30	1447

	20mm
<b>20x20</b>	MP186
<b>20x30</b>	MP183

Ver página 576  
See page 576



**Rodapié**  
Skirting

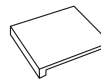

**Peldaño**  
Step

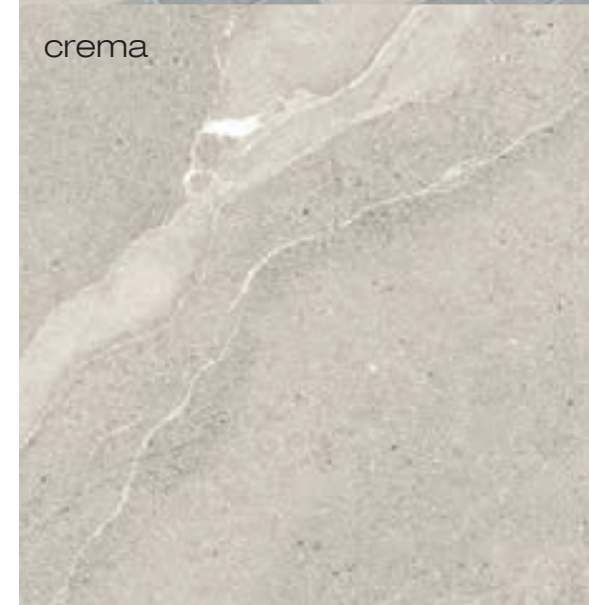





piazza

Piazza blanco 20x20 / 8"x8"



PIAZZA BLANCO 20X30 / 8X12"



PIAZZA GRIS 20X20 / 8X8" \_ 20X30 / 8X12"



PIAZZA GRAFITO 20X30 / 8X12"

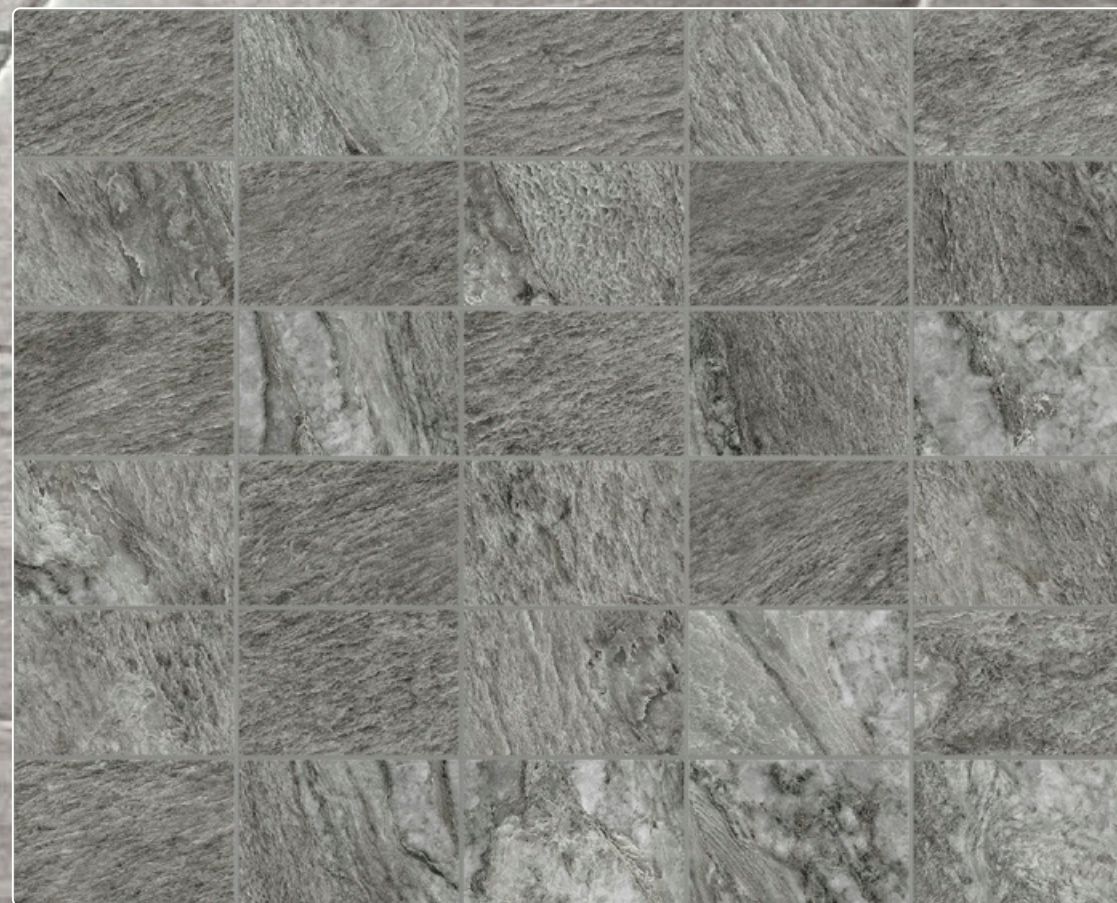



piazza

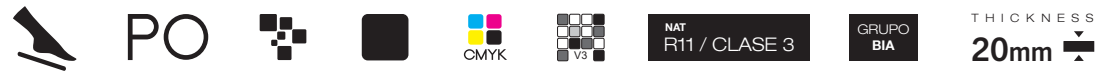

pavimento adz \_ porcelánico \_ masa coloreada \_ mate \_ no rectificado  
 adz floor tile \_ porcelain \_ colored body \_ matt \_ non rectified

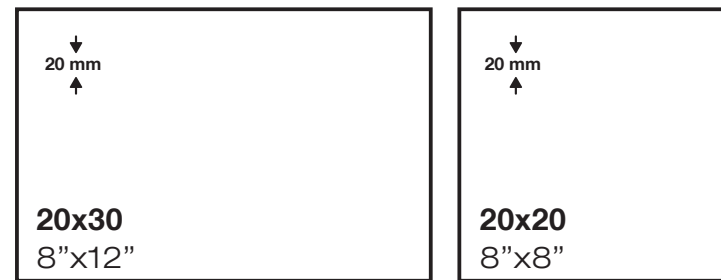

PACKING & SPECIAL PIECES

	Pc/Cj	M2/Cj	Cj/PI	M2/PI	Kg/Cj	Kg/PI
<b>20x20</b>	12	0,48	60	28,8	22,30	1358
<b>20x30</b>	8	0,48	64	30,72	22,30	1447

	20mm
<b>20x20</b>	MP186
<b>20x30</b>	MP183

Ver página 576  
 See page 576



Rodapié  
 Skirting

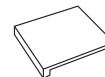

Peldaño  
 Step

Piazza gris 20x30 / 8"x12"



blanco

gris

grafito

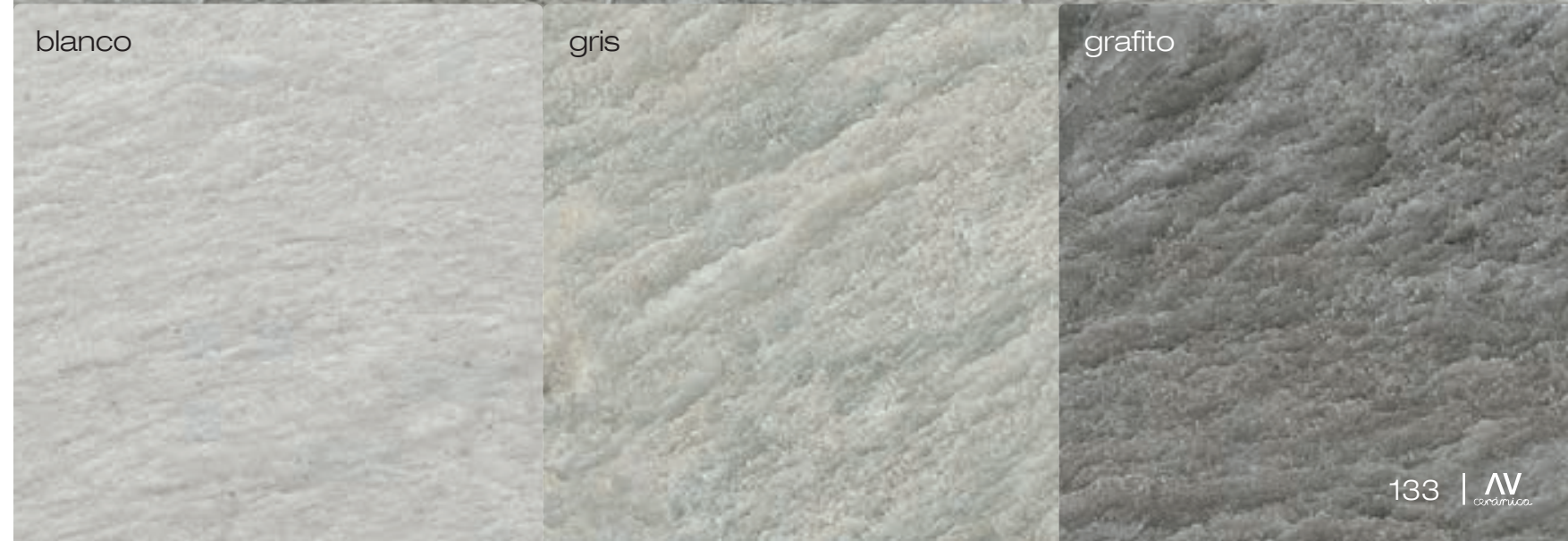





street

Street beige 20x20 / 8"x8"



**STREET BEIGE 20X30 / 8X12"**



**STREET SILVER 20X30 / 8X12"**



**STREET DARK 20X20 / 8x8" \_ 20X30 / 8x12"**





# street



pavimento adz \_ porcelánico \_ masa coloreada \_ mate \_ no rectificado  
 adz floor tile \_ porcelain \_ colored body \_ matt \_ non rectified

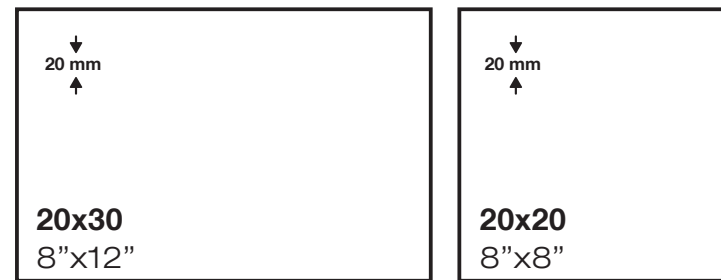

## PACKING & SPECIAL PIECES

	Pc/Cj	M2/Cj	Cj/PI	M2/PI	Kg/Cj	Kg/PI
<b>20x20</b>	12	0,48	60	28,8	22,30	1358
<b>20x30</b>	8	0,48	64	30,72	22,30	1447

	20mm
<b>20x20</b>	MP186
<b>20x30</b>	MP183

**Ver página 576**  
See page 576



**Rodapié**  
Skirting

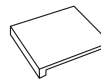

**Peldaño**  
Step

Street beige 20x20 / 8"x8" \_ 20x30 / 8"x12"



beige

silver

dark







highly

polished

## DE

Unser Sortiment, Raffinesse und Tiefe hoch poliert. Die feinste Essenz des Marmors wird mit größerer Brillanz gesehen.

## FR

Notre gamme. Sophistication et profondeur avec notre choix de marbres superpolis.

## EN

Our Highly Polished range, sophistication and depth. The finest essence of marble looks with higher brightness.

## ES

Nuestra gama, sofisticación y profundidad altamente pulidas. La esencia más fina del mármol se ve con mayor brillo.





duomo

Duomo 120x120 / 48"x48"



# duomo



pavimento \_ porcelánico \_ granilla pulida \_ rectificado  
 floor tile \_ porcelain \_ highly polished \_ rectified

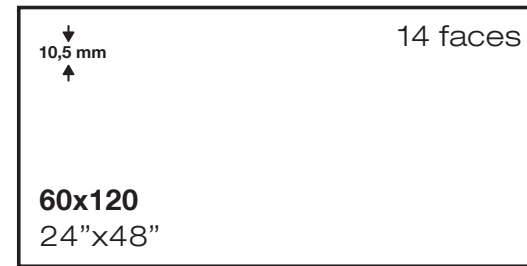
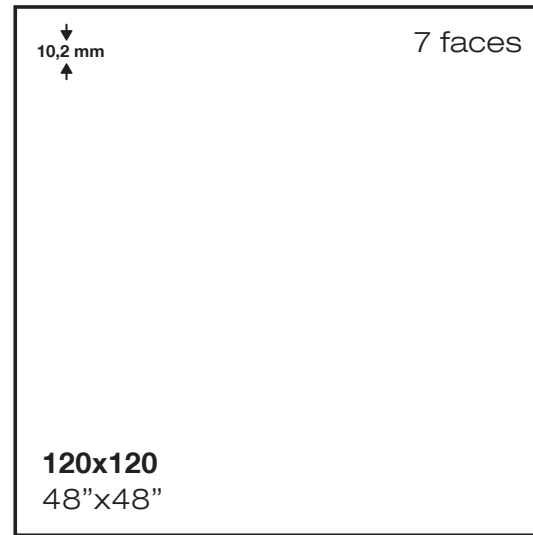

Duomo 120x120 / 48"x48"

## PACKING & SPECIAL PIECES

	Pc/Cj	M2/Cj	Cj/Pl	M2/Pl	Kg/Cj	Kg/Pl		Cód.
<b>60x120</b>	2	1,44	32	46,08	34,5	1124	<b>60x120</b>	MP324
<b>120x120</b>	1	1,44	36	51,84	36,36	1328,96	<b>120x120</b>	MP334

 **Ver página 582**  
 See page 582



**Rodapié**  
 Skirting

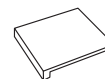

**Peldaño**  
 Step

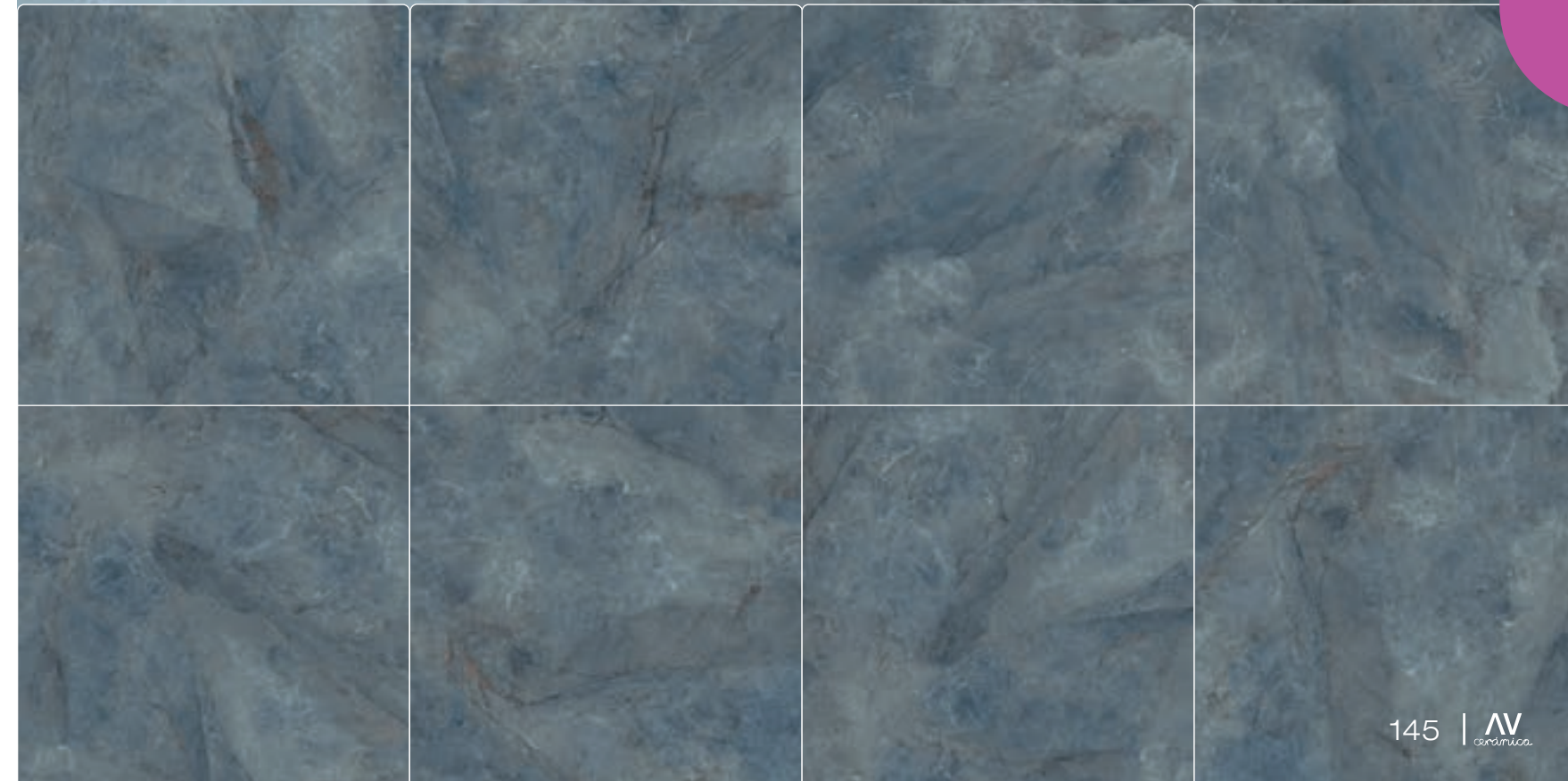





exedra

Exedra brown 120x120 / 48"x48" \_ Exedra brown 60x120 / 24"x48" \_ Makai haya 23x120 / 10"x48"



# exedra



pavimento \_ porcelánico \_ granilla pulida \_ rectificado  
 floor tile \_ porcelain \_ highly polished \_ rectified

Exedra black 120x120 / 48"x48"

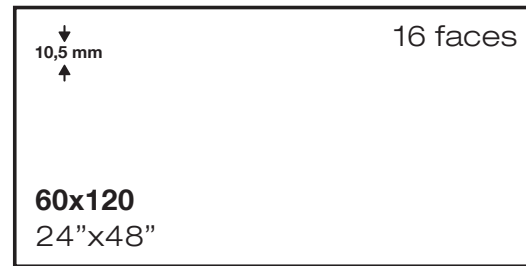
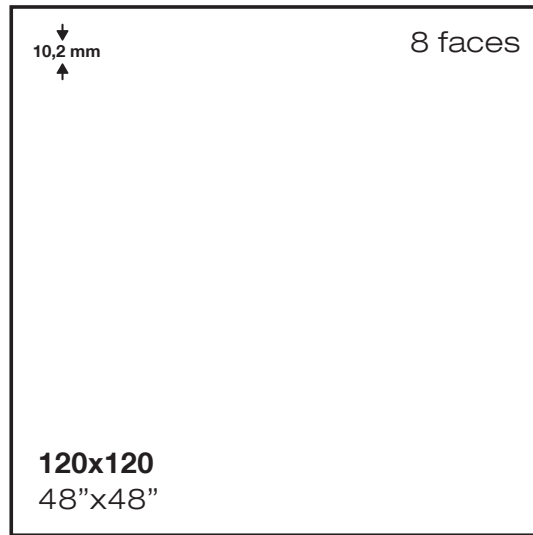

## PACKING & SPECIAL PIECES

	Pc/Cj	M2/Cj	Cj/Pl	M2/Pl	Kg/Cj	Kg/Pl
<b>60x120</b>	2	1,44	32	46,08	34,5	1124
<b>120x120</b>	1	1,44	36	51,84	36,36	1328,96

	Cód.
<b>60x120</b>	MP324
<b>120x120</b>	MP334

Ver página 582  
 See page 582

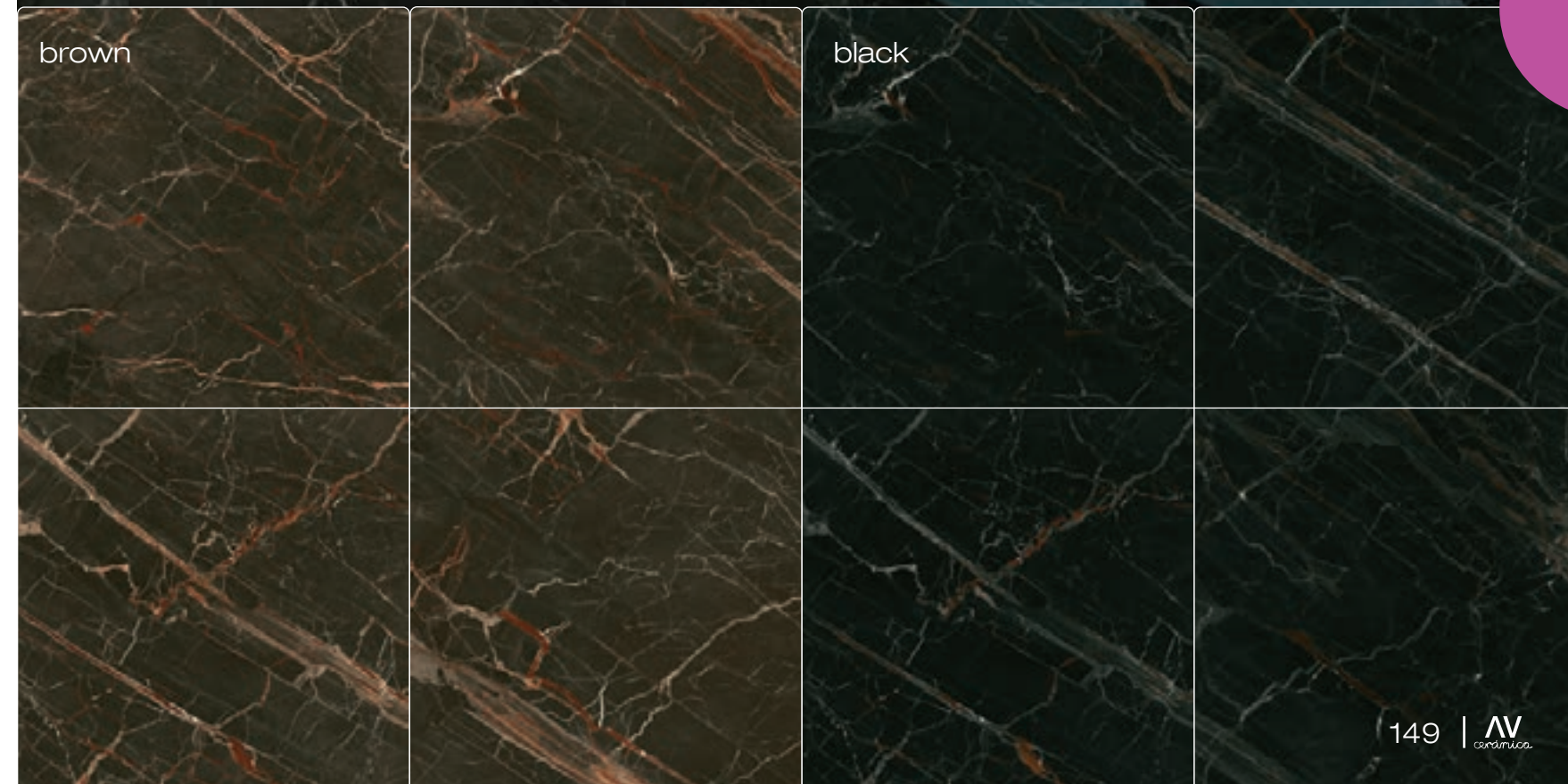





leeds

Leeds 120x120 / 48"x48"



# leeds



pavimento \_ porcelánico \_ granilla pulida \_ rectificado  
 floor tile \_ porcelain \_ highly polished \_ rectified

Leeds 120x120 / 48"x48"

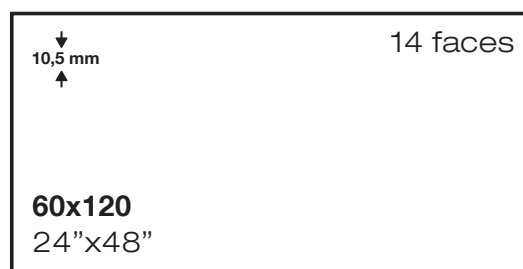
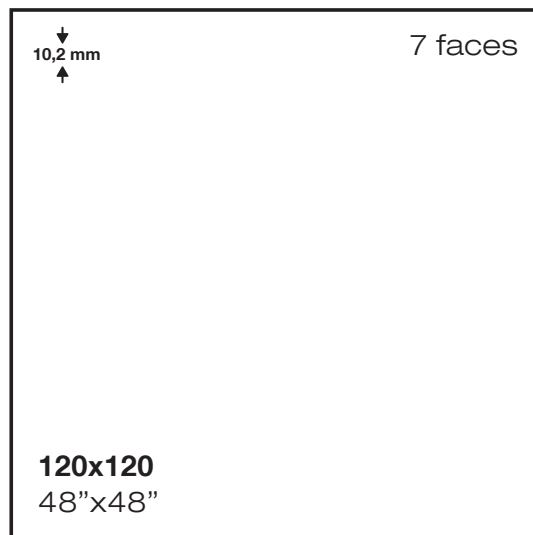

## PACKING & SPECIAL PIECES

	Pc/Cj	M2/Cj	Cj/Pl	M2/Pl	Kg/Cj	Kg/Pl	Cód.
<b>60x120</b>	2	1,44	32	46,08	34,5	1124	<b>60x120</b> MP324
<b>120x120</b>	1	1,44	36	51,84	36,36	1328,96	<b>120x120</b> MP334

Ver página 582  
 See page 582







nilo

Nilo azul 120x120 / 48"x48"



nilo



pavimento \_ porcelánico \_ granilla pulida \_ rectificado  
 floor tile \_ porcelain \_ highly polished \_ rectified

Nilo esmeralda 120x120 / 48"x48"

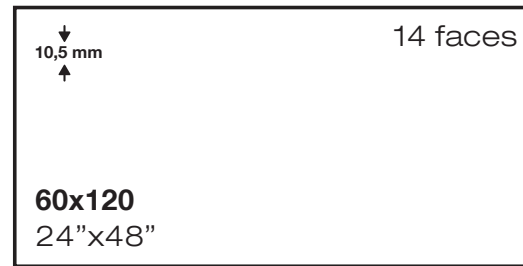
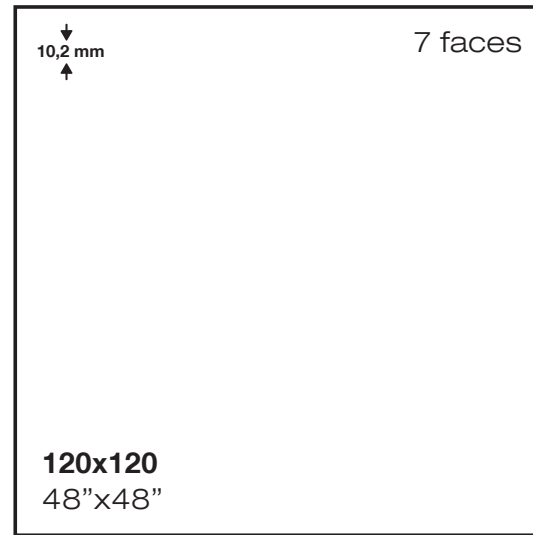

PACKING & SPECIAL PIECES

	Pc/Cj	M2/Cj	Cj/PI	M2/PI	Kg/Cj	Kg/PI
<b>60x120</b>	2	1,44	32	46,08	34,5	1124
<b>120x120</b>	1	1,44	36	51,84	36,36	1328,96

	Cód.
<b>60x120</b>	MP324
<b>120x120</b>	MP334

Ver página 582  
 See page 582



Rodapié  
 Skirting

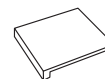

Peldaño  
 Step

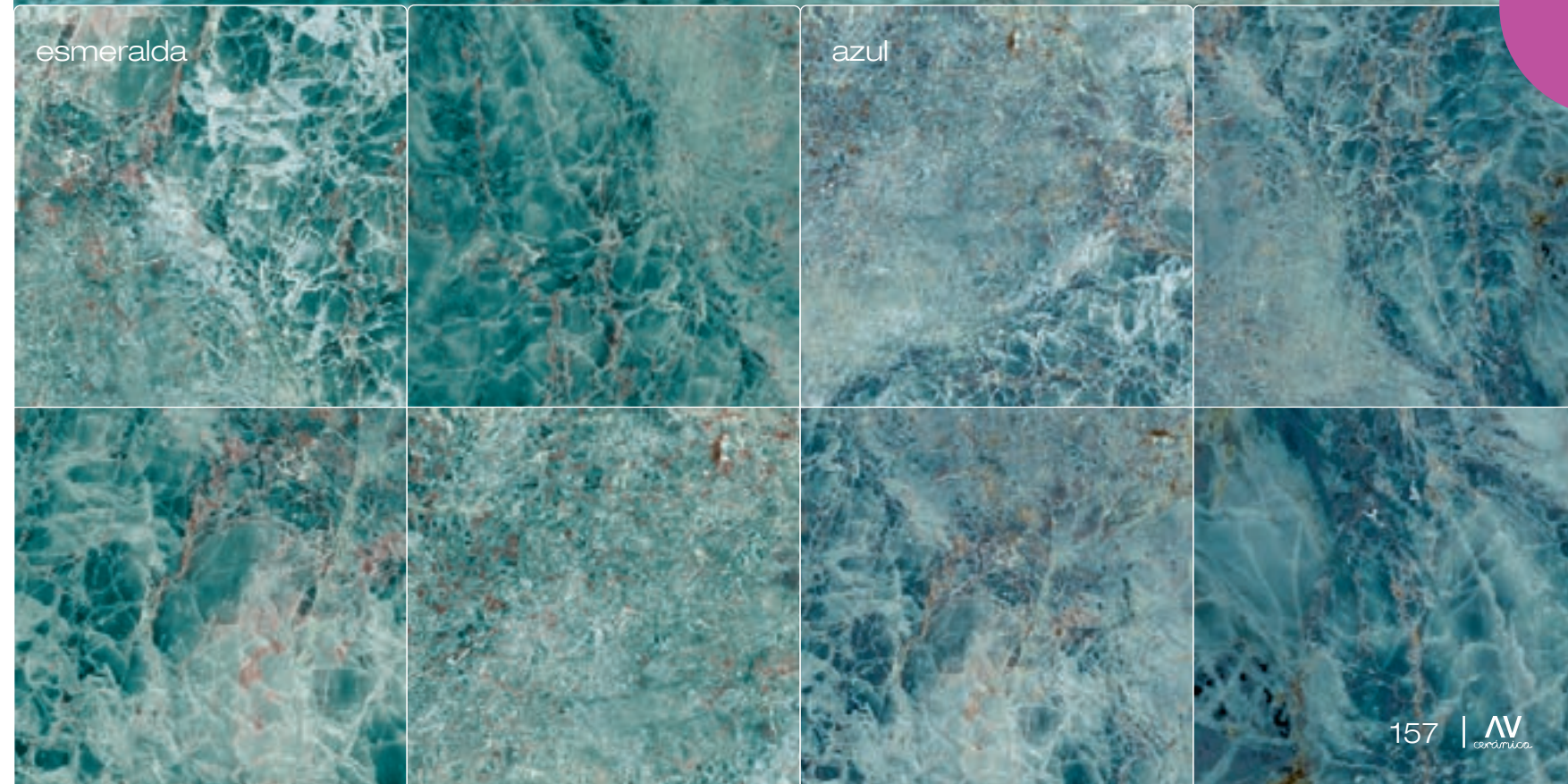





strom

Strom 120x120 / 48"x48"



# Strom



pavimento \_ porcelánico \_ granilla pulida \_ rectificado  
 floor tile \_ porcelain \_ highly polished \_ rectified

Strom 120x120 / 48"x48"

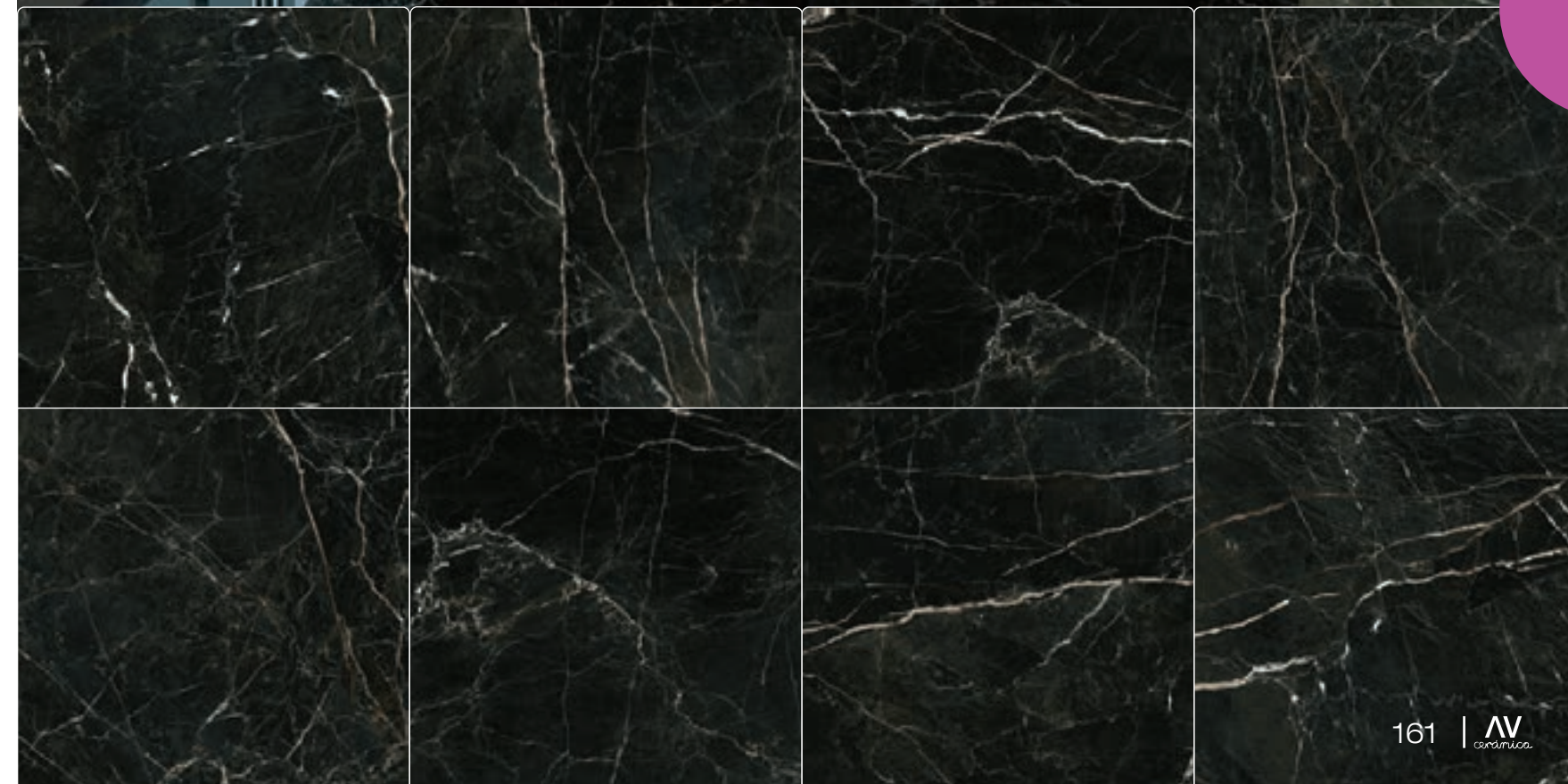
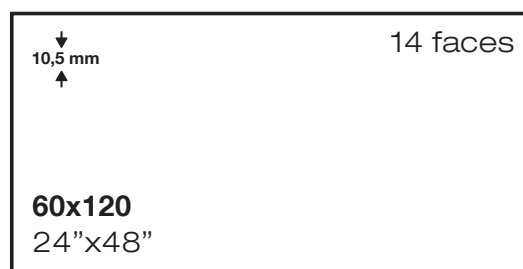
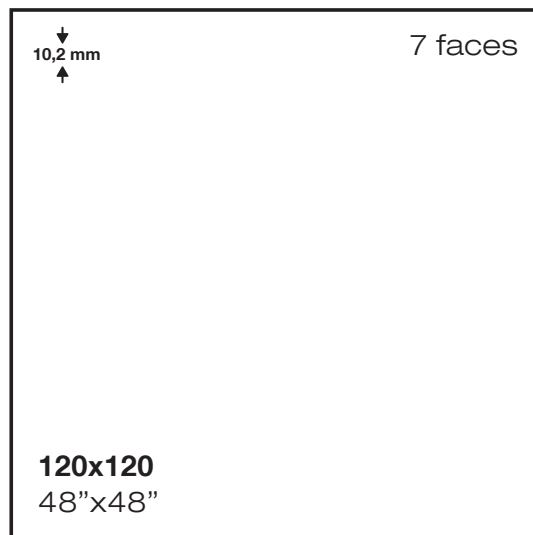

## PACKING & SPECIAL PIECES

	Pc/Cj	M2/Cj	Cj/Pl	M2/Pl	Kg/Cj	Kg/Pl	Cód.
<b>60x120</b>	2	1,44	32	46,08	34,5	1124	<b>60x120</b> MP324
<b>120x120</b>	1	1,44	36	51,84	36,36	1328,96	<b>120x120</b> MP334

**Ver página 582**  
See page 582

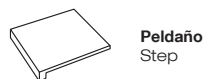





## DE

Unser Sortiment mit einem brillanten Effekt, der geschaffen wurde, um Raffinesse in den Raum zu bringen Platz.

## FR

Notre gamme à effet brillant créée pour apporter de la sophistication à l'espace.

## EN

Our product range with a brilliant effect created to bring sophistication to the space.

## ES

Nuestra gama con efecto brillante creada para aportar sofisticación al espacio.

christy • polin • tesa





christy

Christy blanco 120x120 / 48"x48" \_ Christy blanco 60x120 / 24"x48"



# christy



pavimento \_ porcelánico \_ sugar lappato \_ rectificado  
 floor tile \_ porcelain \_ sugar lappato \_ rectified

Christy marfil 120x120 / 48"x48"

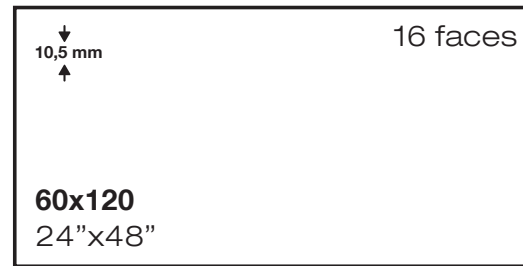
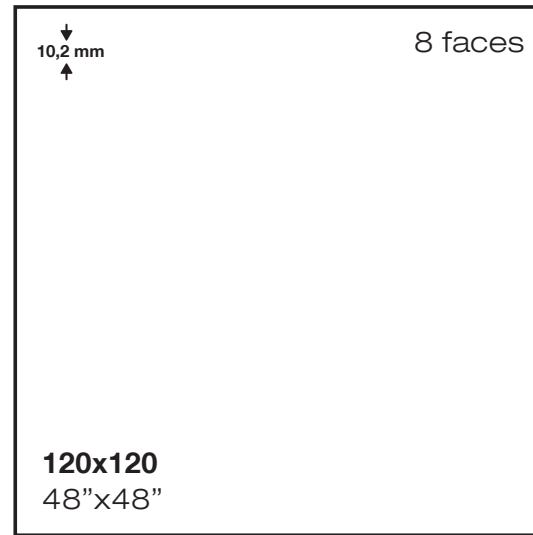

## PACKING & SPECIAL PIECES

	Pc/Cj	M2/Cj	Cj/PI	M2/PI	Kg/Cj	Kg/PI
<b>60x120</b>	2	1,44	32	46,08	34,5	1124
<b>120x120</b>	1	1,44	36	51,84	36,36	1328,96

	Cód.
<b>60x120</b>	MP440
<b>120x120</b>	MP430

**Ver página 582**  
See page 582



**Rodapié**  
Skirting

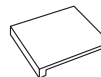

**Peldaño**  
Step

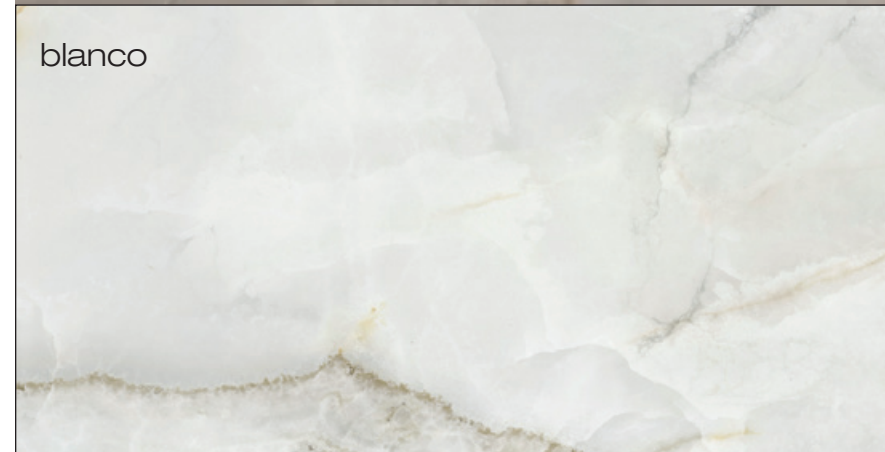

blanco

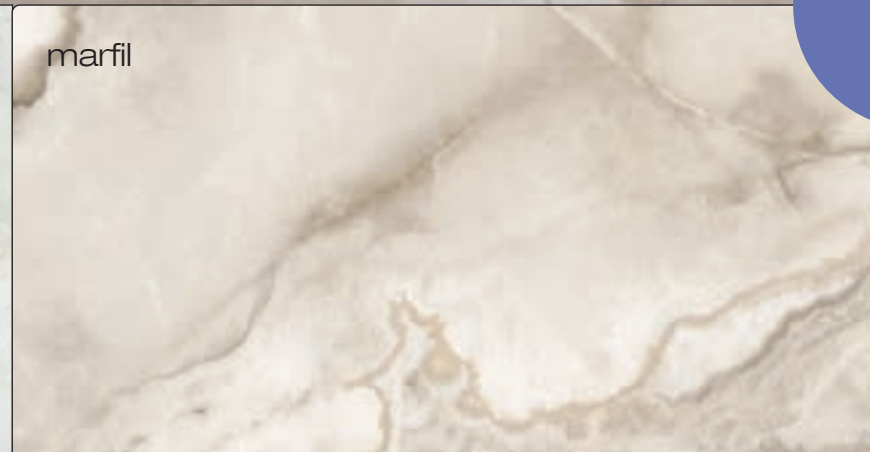

marfil

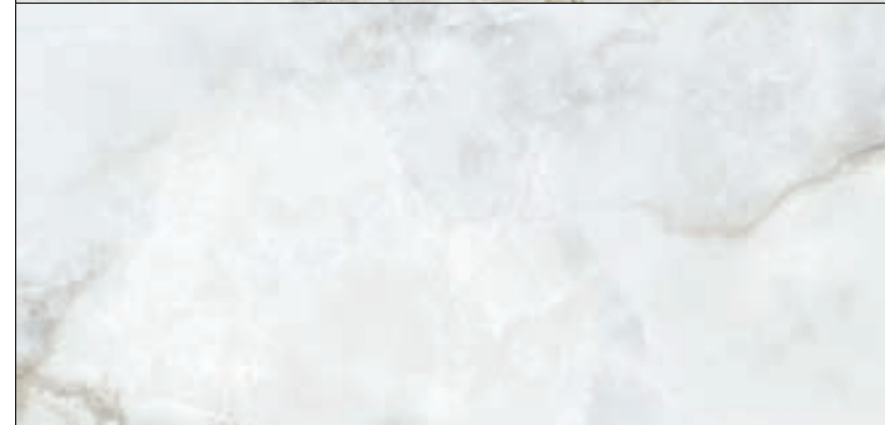





polin

Polin ferro 120x120 / 48"x48" \_ Polin ferro 60x120 / 24"x48"



polin



pavimento \_ porcelánico \_ sugar lappato \_ rectificado  
 floor tile \_ porcelain \_ sugar lappato \_ rectified

Polin alluminio 120x120 / 48"x48"

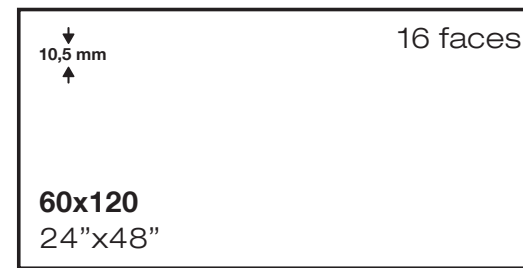
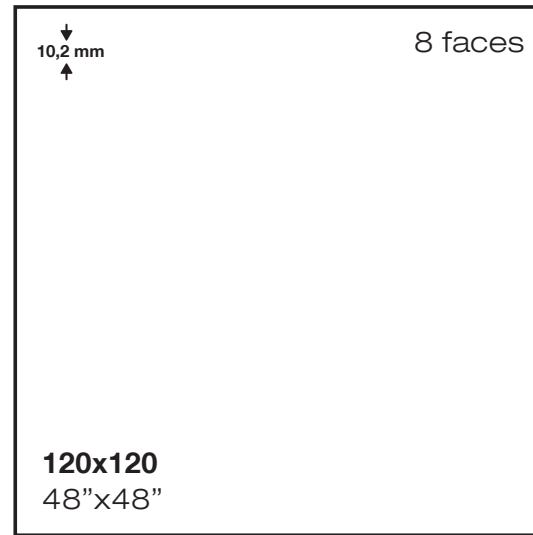

PACKING & SPECIAL PIECES

	Pc/Cj	M2/Cj	Cj/PI	M2/PI	Kg/Cj	Kg/PI		Cód.
<b>60x120</b>	2	1,44	32	46,08	34,5	1124	<b>60x120</b>	MP440
<b>120x120</b>	1	1,44	36	51,84	36,36	1328,96	<b>120x120</b>	MP430

Ver página 582  
 See page 582



Rodapié  
 Skirting

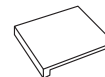

Peldaño  
 Step





tesa

Tesa blue 600x120 / 24"x48" \_ Fanlo haya 25x150 / 10"x59"



# tesa



pavimento \_ porcelánico \_ sugar lappato \_ rectificado  
 floor tile \_ porcelain \_ sugar lappato \_ rectified

↓  
10,5 mm  
↑

16 faces

**60x120**  
24"x48"

## PACKING & SPECIAL PIECES

	Pc/Cj	M2/Cj	Cj/PI	M2/PI	Kg/Cj	Kg/PI
<b>60x120</b>	2	1,44	32	46,08	34,5	1124

	Cód.
<b>60x120</b>	MP440

**Ver página 582**  
See page 582



**Rodapié**  
Skirting

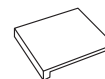

**Peldaño**  
Step



Tesa grey 60x120 / 24"x48"

sky

green

blue

grey





## DE

Perfekte reproduktion der feinsten details der Natur.

## FR

Reproduction parfaite des meilleurs détails de la nature.

## EN

The perfect depiction of nature reflected in tiles.

## ES

Reproducción perfecta de los mejores detalles de la naturaleza.

aeris • allure • aura • belice • bruce • bután • chiara • clothy • elder forum • golden • kendall • kristen • lance • lindsay • lugano • marmo

orix • pol. calhea • pulsar • riola • tekali • tyra • unli blue • uyuni • viterbo • zoey





aeris

Aeris 120x120 / 48"x48"



# aeris



pavimento \_ porcelánico \_ pulido \_ rectificado  
 floor tile \_ porcelain \_ polished \_ rectified

Aeris 90x90 / 36"x36"

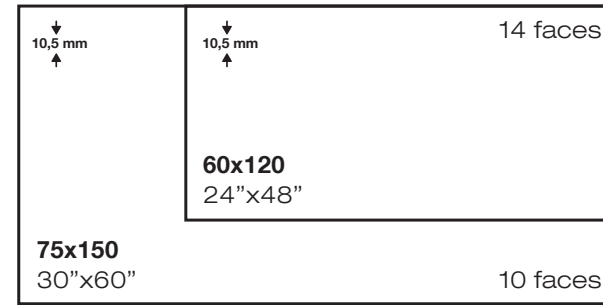
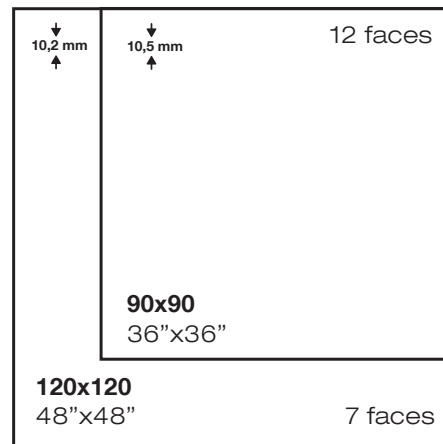

## PACKING & SPECIAL PIECES

	Pc/Cj	M2/Cj	Cj/PI	M2/PI	Kg/Cj	Kg/PI
60x120	2	1,44	32	46,08	34,5	1124
90x90	2	1,62	27	43,74	40	1100
120x120	1	1,44	36	51,84	36,36	1328,96
75x150	1	1,16	40	45,2	28	1140

	Pulido
60x120	MP323
90x90	MP204
120x120	MP333
75x150	MP343

Ver página 582  
See page 582



Rodapié  
Skirting

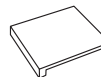

Peldaño  
Step

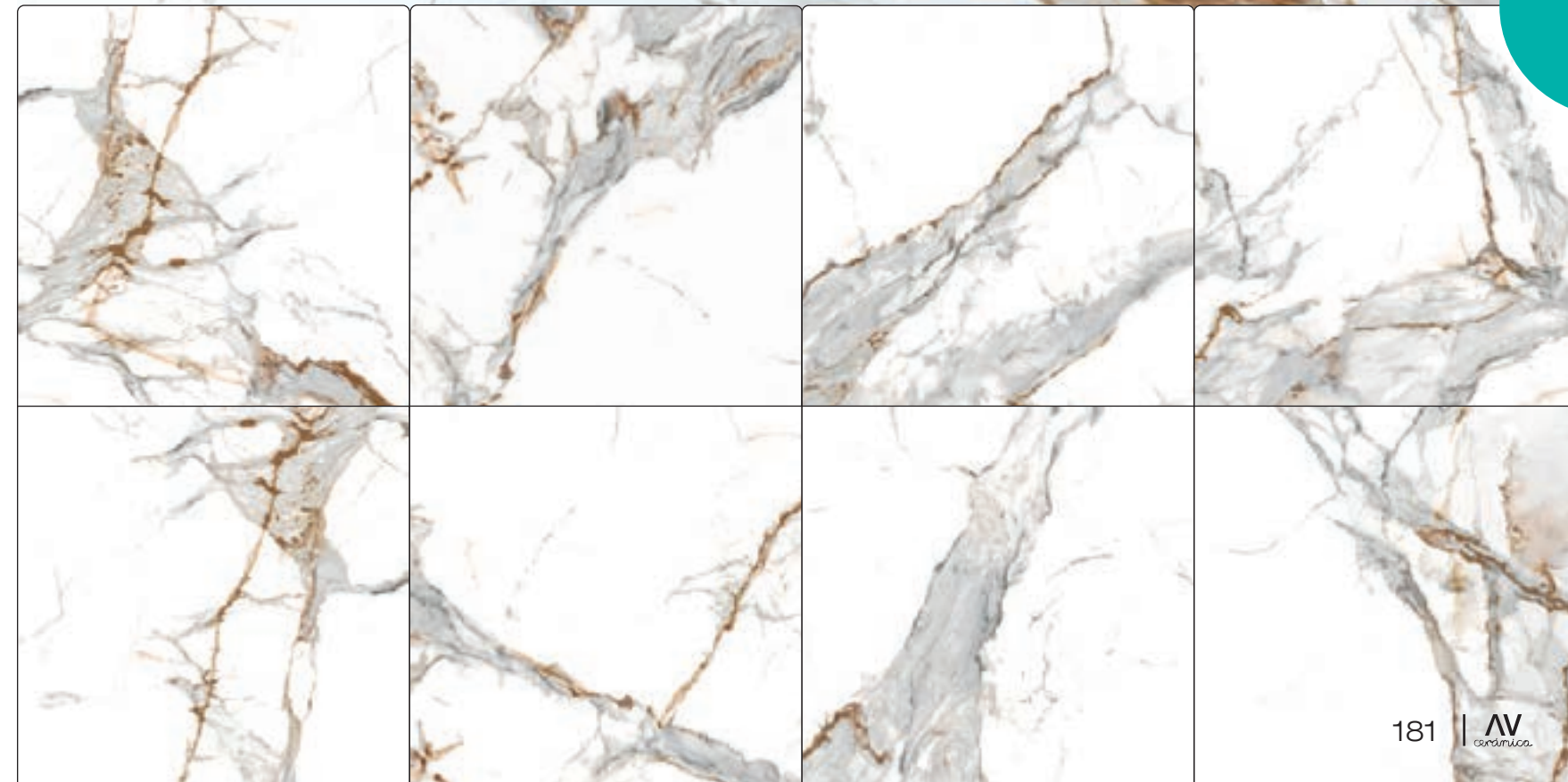





allure

Allure gris 90x90 / 36"x36"



# allure



pavimento \_ porcelánico \_ pulido \_ rectificado  
 floor tile \_ porcelain \_ polished \_ rectified

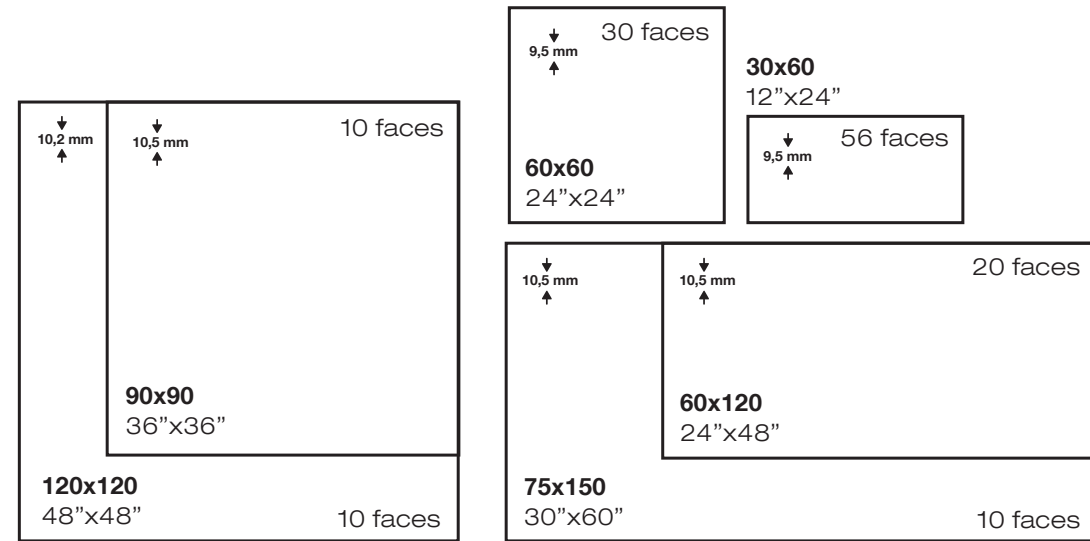

## PACKING & SPECIAL PIECES

	Pc/Cj	M2/Cj	Cj/PI	M2/PI	Kg/Cj	Kg/PI
<b>30x60</b>	7	1,26	40	50,4	24,1	984
<b>60x60</b>	4	1,44	30	43,2	30	920
<b>60x120</b>	2	1,44	32	46,08	34,5	1124
<b>90x90</b>	2	1,62	27	43,74	40	1100
<b>120x120</b>	1	1,44	36	51,84	36,36	1328,96
<b>75x150</b>	1	1,16	40	45,2	28	1140

	Pulido
<b>30x60</b>	MP124
<b>60x60</b>	MP174
<b>60x120</b>	MP323
<b>90x90</b>	MP204
<b>120x120</b>	MP333
<b>75x150</b>	MP343

**Ver página 582**  
See page 582



**Rodapié**  
Skirting

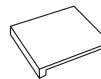

**Peldaño**  
Step

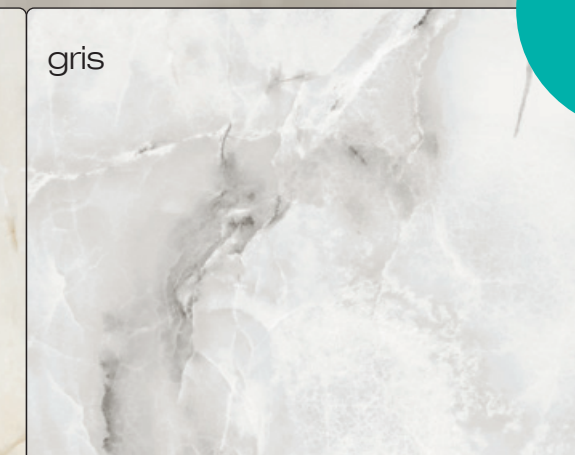
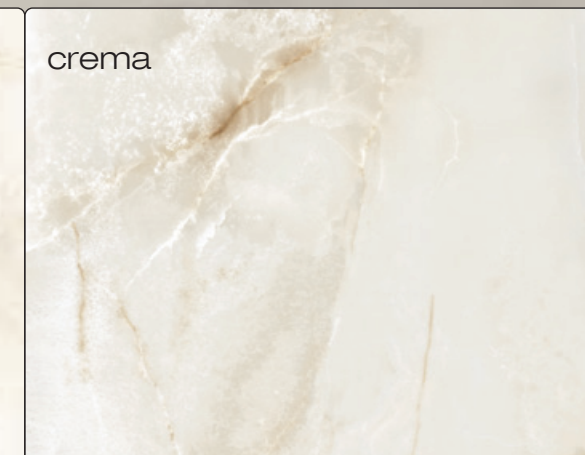
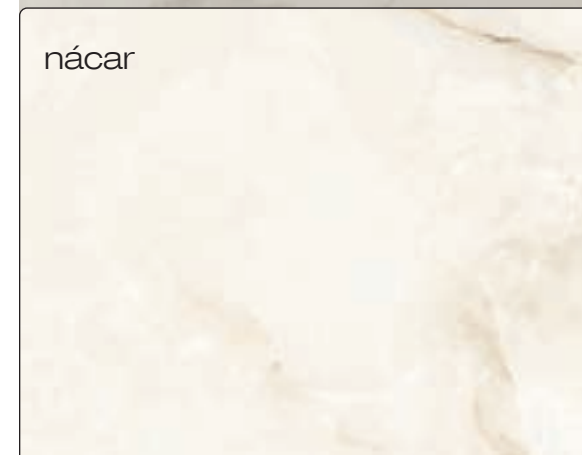





aura

Aura 120x120 / 48"x48"



# aura



pavimento \_ porcelánico \_ pulido \_ rectificado  
 floor tile \_ porcelain \_ polished \_ rectified

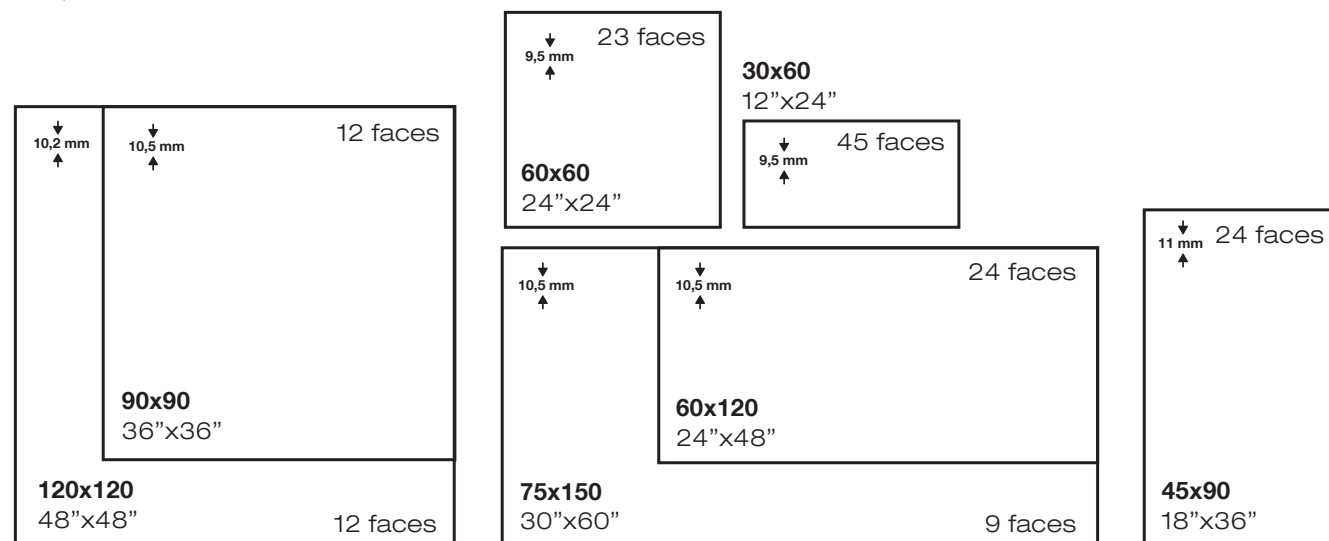

**Serie también disponible en mate pág. 260**  
 Series also available in matt p. 260  
 Série également disponible en mat p. 260  
 Serie auch in matt erhältlich p. 260



## PACKING & SPECIAL PIECES

	Pc/Cj	M2/Cj	Cj/PI	M2/PI	Kg/Cj	Kg/PI
<b>30x60</b>	7	1,26	40	50,4	24,1	984
<b>45x90</b>	3	1,21	44	53,24	28,7	1282,8
<b>60x60</b>	4	1,44	30	43,2	30	920
<b>60x120</b>	2	1,44	32	46,08	34,5	1124
<b>90x90</b>	2	1,62	27	43,74	40	1100
<b>120x120</b>	1	1,44	36	51,84	36,36	1328,96
<b>75x150</b>	1	1,16	40	45,2	28	1140

	Pulido
<b>30x60</b>	MP124
<b>45x90</b>	MP310
<b>60x60</b>	MP174
<b>60x120</b>	MP323
<b>90x90</b>	MP204
<b>120x120</b>	MP333
<b>75x150</b>	MP343

**Ver página 582**  
 See page 582

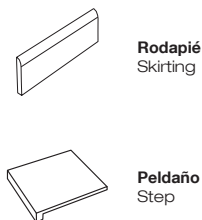

Aura 90x90 / 36"x36"







belice

Belice black 60x120 / 24"x48" \_ Belice black 120x120 / 48"x48"



# belice



pavimento \_ porcelánico \_ pulido \_ rectificado  
 floor tile \_ porcelain \_ polished \_ rectified

**Serie también disponible en mate.**  
 Series also available in matt.  
 Série également disponible en mat.  
 Serie auch in matt erhältlich.

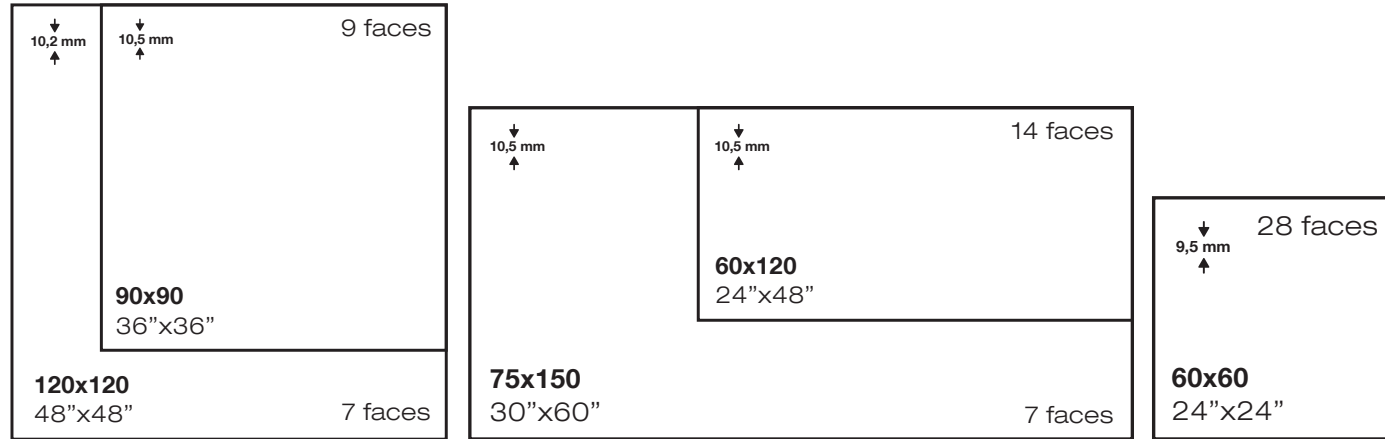

## PACKING & SPECIAL PIECES

	Pc/Cj	M2/Cj	Cj/PI	M2/PI	Kg/Cj	Kg/PI
<b>60x60</b>	4	1,44	30	43,2	30	920
<b>90x90</b>	2	1,62	27	43,74	40	1100
<b>60x120</b>	2	1,44	32	46,08	34,5	1124
<b>120x120</b>	1	1,44	36	51,84	36,36	1328,96
<b>75x150</b>	1	1,16	40	45,2	28	1140

	Pulido	Mate
<b>60x60</b>	MP174	MP175
<b>90x90</b>	MP204	MP207
<b>60x120</b>	MP323	MP320
<b>120x120</b>	MP333	MP330
<b>75x150</b>	MP343	MP340

**Ver página 582**  
 See page 582

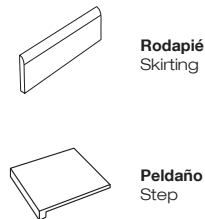

Belice moccha 120x120 / 48"x48"







bruce

Bruce matt 60x60 / 24"x24"



# bruce



pavimento \_ porcelánico \_ pulido \_ rectificado  
 floor tile \_ porcelain \_ polished \_ rectified

**Serie disponible en mate excepto en formato 90x180.**  
 Series available in matt except 90x180 size.  
 Série disponible en mat sauf format 90x180.  
 Serien in matt erhältlich außer Format 90x180.

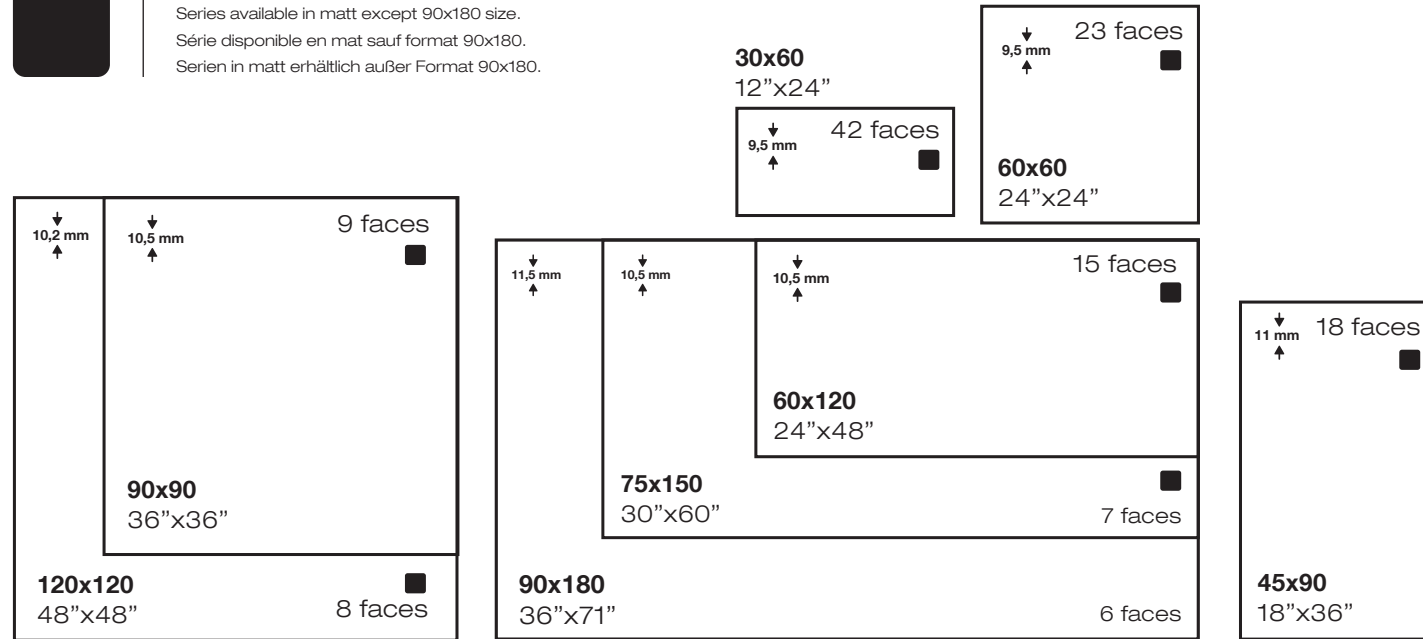

## PACKING & SPECIAL PIECES

	Pc/Cj	M2/Cj	Cj/PI	M2/PI	Kg/Cj	Kg/PI	Pulido	Mate
<b>30x60</b>	7	1,26	40	50,4	24,1	984	MP124	MP120
<b>45x90</b>	3	1,21	44	53,24	28,7	1282,8	MP310	MP300
<b>60x60</b>	4	1,44	30	43,2	30	920	MP174	MP175
<b>60x120</b>	2	1,44	32	46,08	34,5	1124	MP323	MP320
<b>90x90</b>	2	1,62	27	43,74	40	1100	MP204	MP207
<b>120x120</b>	1	1,44	36	51,84	36,36	1328,96	MP333	MP330
<b>75x150</b>	1	1,16	40	45,2	28	1140	MP343	MP340
<b>90x180</b>	1	1,62	24	38,8	45,5	1112	MP352	-

**Ver página 582**  
See page 582



**Rodapié**  
Skirting

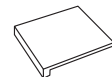

**Peldaño**  
Step

Bruce polished 90x90 / 36"x36"







bután

Bután marengo 60x120 / 24"x48"



# bután



pavimento \_ porcelánico \_ pulido \_ rectificado  
 floor tile \_ porcelain \_ polished \_ rectified

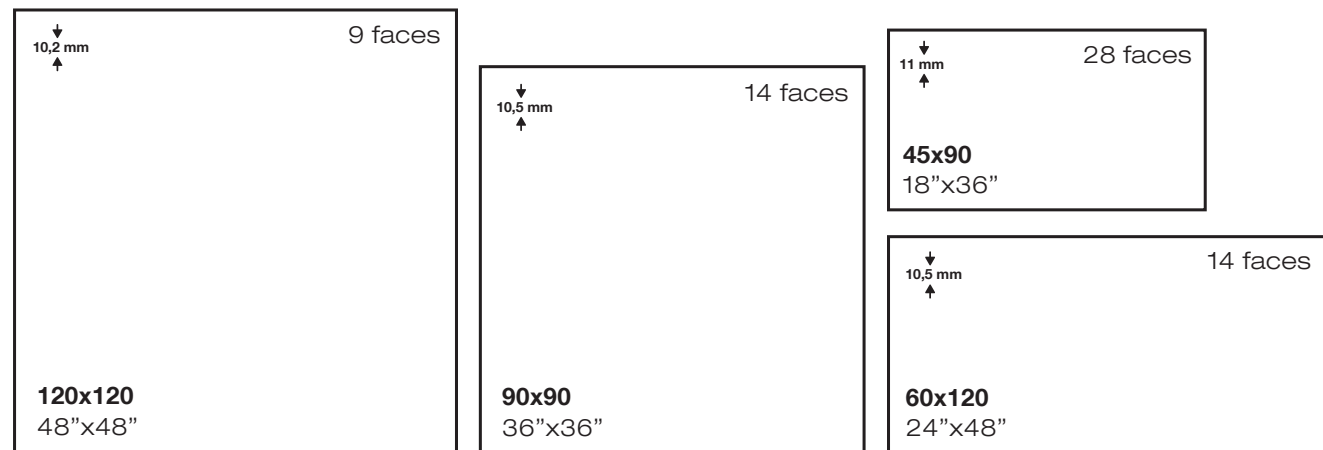

## PACKING & SPECIAL PIECES

	Pc/Cj	M2/Cj	Cj/PI	M2/PI	Kg/Cj	Kg/PI
<b>45x90</b>	3	1,21	44	53,24	28,7	1282,8
<b>60x120</b>	2	1,44	32	46,08	34,5	1124
<b>90x90</b>	2	1,62	27	43,74	40	1100
<b>120x120</b>	1	1,44	36	51,84	36,36	1328,96

	Pulido
<b>45x90</b>	MP310
<b>60x120</b>	MP323
<b>90x90</b>	MP204
<b>120x120</b>	MP333

Ver página 582  
 See page 582



Rodapié  
 Skirting

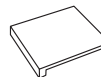

Peldaño  
 Step

Bután marfil 90x90 / 36"x36"







chiara

Chiara 60x120 / 24"x48"



# chiara



pavimento \_ porcelánico \_ pulido \_ rectificado  
 floor tile \_ porcelain \_ polished \_ rectified

**Serie también disponible en mate.**  
 Series also available in matt.  
 Série également disponible en mat.  
 Serie auch in matt erhältlich.

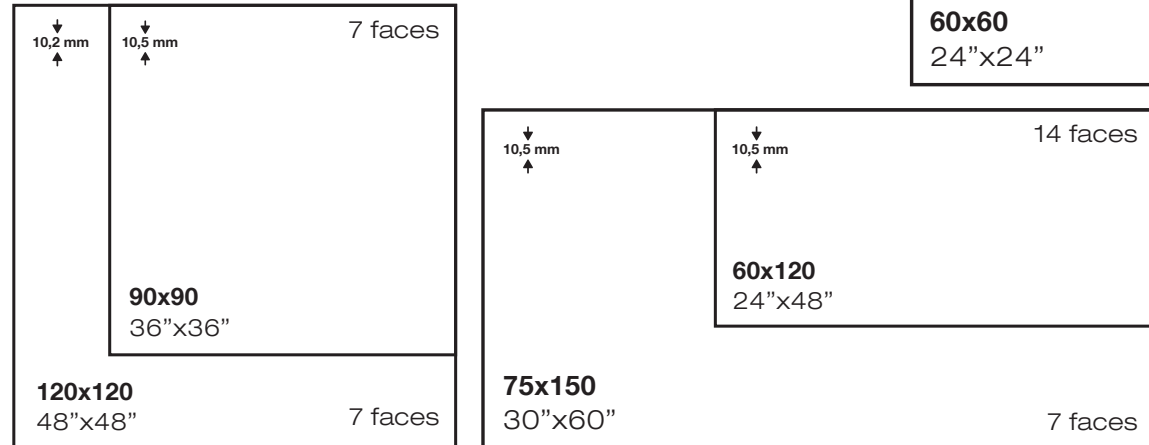

## PACKING & SPECIAL PIECES

	Pc/Cj	M2/Cj	Cj/PI	M2/PI	Kg/Cj	Kg/PI
<b>60x60</b>	4	1,44	30	43,2	30	920
<b>90x90</b>	2	1,62	27	43,74	40	1100
<b>60x120</b>	2	1,44	32	46,08	34,5	1124
<b>120x120</b>	1	1,44	36	51,84	36,36	1328,96
<b>75x150</b>	1	1,16	40	45,2	28	1140

	Pulido	Mate
<b>60x60</b>	MP174	MP175
<b>90x90</b>	MP204	MP207
<b>60x120</b>	MP323	MP320
<b>120x120</b>	MP333	MP330
<b>75x150</b>	MP343	MP340

**Ver página 582**  
 See page 582

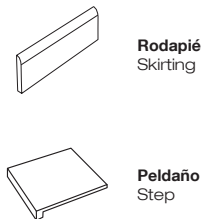

Chiara 120x120 / 48"x48"







clothny

Clothy perla 60x120 / 24"x48" \_ Clothy perla 120x120 / 48"x48"



# cloth



pavimento \_ porcelánico \_ pulido \_ rectificado  
 floor tile \_ porcelain \_ polished \_ rectified

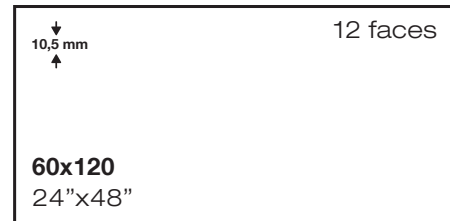
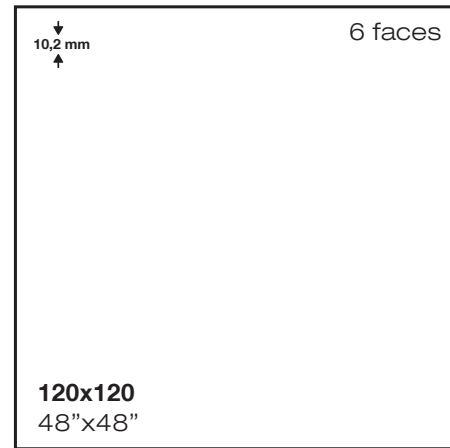

## PACKING & SPECIAL PIECES

	Pc/Cj	M2/Cj	Cj/PI	M2/PI	Kg/Cj	Kg/PI
<b>60x120</b>	2	1,44	32	46,08	34,5	1124
<b>120x120</b>	1	1,44	36	51,84	36,36	1328,96

	Pulido
<b>60x120</b>	MP323
<b>120x120</b>	MP333

**Ver página 582**  
See page 582

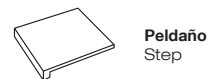

Clothy gris 120x120 / 48"x48"







elder

Elder taupe 60x120 / 24"x48" \_ Elder taupe 120x120 / 48"x48"



# elder



pavimento \_ porcelánico \_ pulido \_ rectificado  
 floor tile \_ porcelain \_ polished \_ rectified



**Serie también disponible en mate.**  
 Series also available in matt.  
 Série également disponible en mat.  
 Serie auch in matt erhältlich.

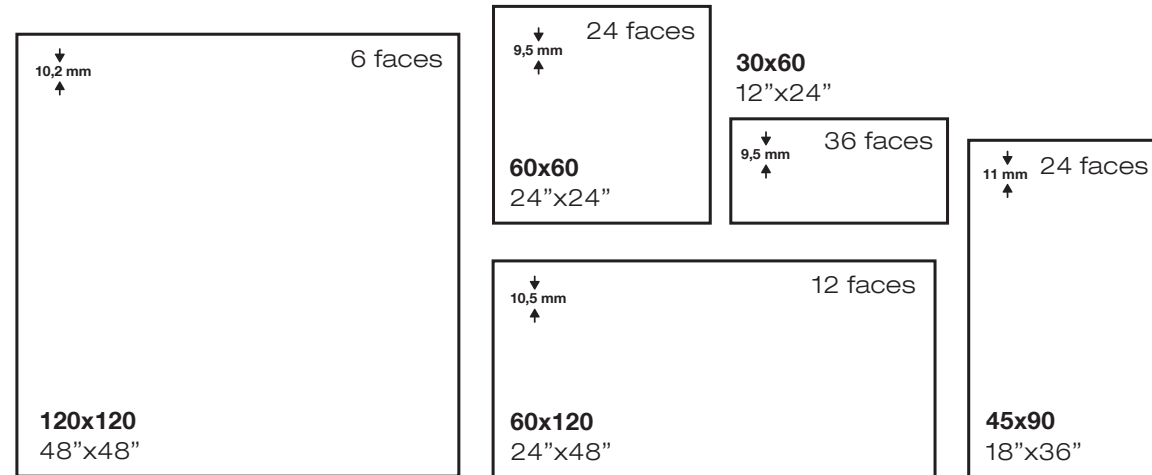

## PACKING & SPECIAL PIECES

	Pc/Cj	M2/Cj	Cj/PI	M2/PI	Kg/Cj	Kg/PI
<b>30x60</b>	7	1,26	40	50,4	24,1	984
<b>45x90</b>	3	1,21	44	53,24	28,7	1282,8
<b>60x60</b>	4	1,44	30	43,2	30	920
<b>60x120</b>	2	1,44	32	46,08	34,5	1124
<b>120x120</b>	1	1,44	36	51,84	36,36	1328,96

	Pulido	Mate
<b>30x60</b>	MP124	MP126
<b>45x90</b>	MP310	MP300
<b>60x60</b>	MP174	MP175
<b>60x120</b>	MP323	MP320
<b>120x120</b>	MP333	MP330

**Ver página 582**  
 See page 582



**Rodapié**  
 Skirting

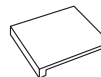

**Peldaño**  
 Step

Elder gris 120x120 / 48"x48"







Forum

Forum 60x120 / 24"x48"



# FORUM



pavimento \_ porcelánico \_ pulido \_ rectificado  
 floor tile \_ porcelain \_ polished \_ rectified

Forum 60x120 / 24"x48"

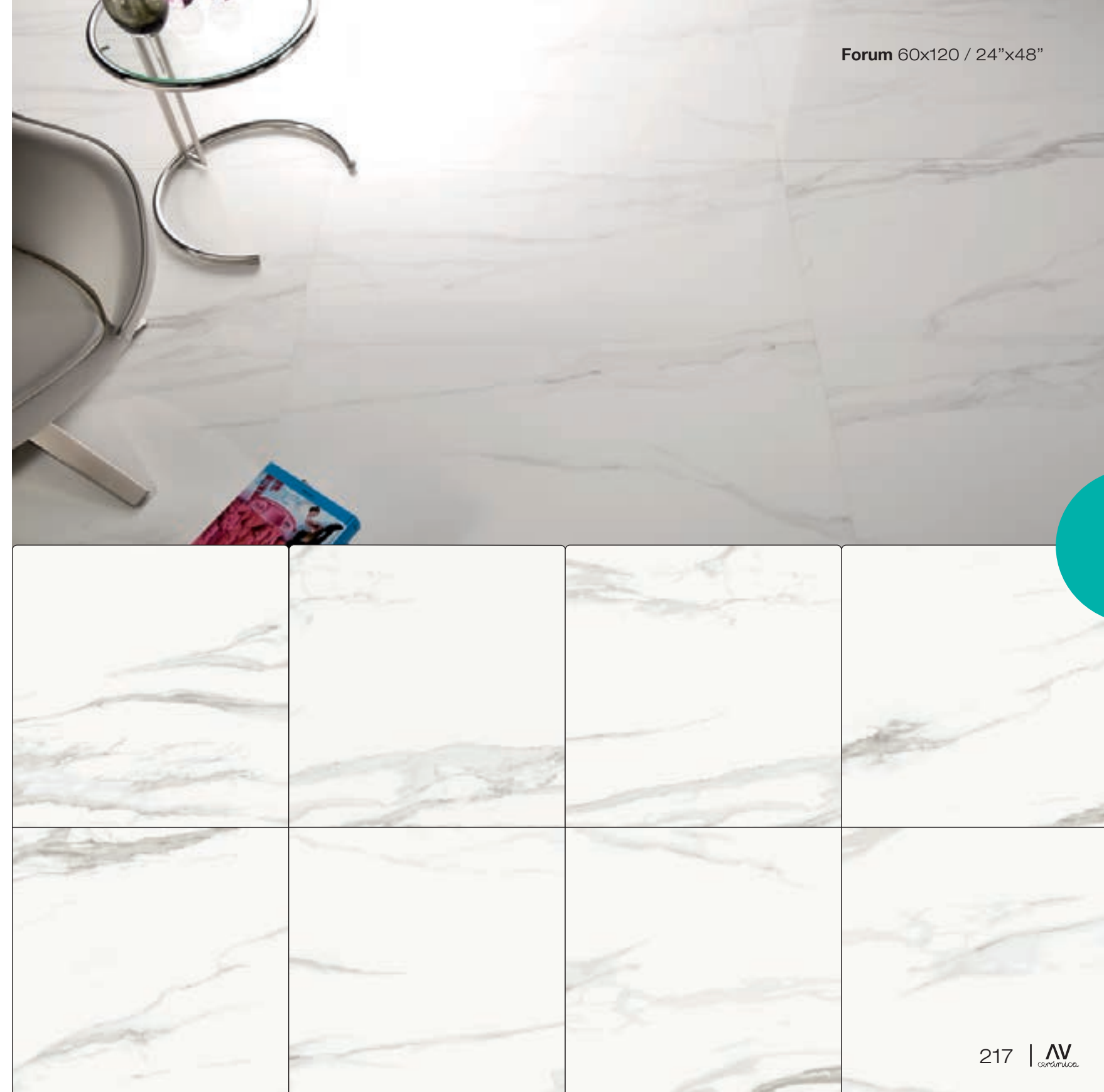
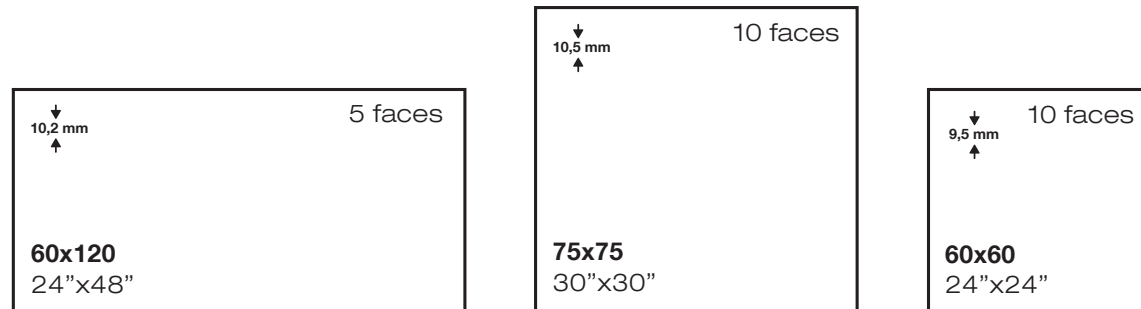

## PACKING & SPECIAL PIECES

	Pc/Cj	M2/Cj	Cj/PI	M2/PI	Kg/Cj	Kg/PI
<b>60x60</b>	4	1,44	30	43,2	30	920
<b>75x75</b>	3	1,69	30	50,7	41,2	1256
<b>60x120</b>	2	1,44	32	46,08	34,5	1124

	Pulido
<b>60x60</b>	MP174
<b>75x75</b>	MP192
<b>60x120</b>	MP323

**Ver página 582**  
See page 582



**Rodapié**  
Skirting

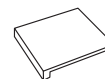

**Peldaño**  
Step





golden

Golden 90x90 / 36"x36"



# golden



pavimento \_ porcelánico \_ pulido \_ rectificado  
 floor tile \_ porcelain \_ polished \_ rectified

**Formatos 30x60, 60x60 y 60x120 también disponibles en mate.**  
 Sizes 30x60, 60x60 and 60x120 also available in matt.  
 Formats 30x60, 60x60 et 60x120 également disponible en mat.  
 Formate 30x60, 60x60 und 60x120 auch in matt erhältlich.

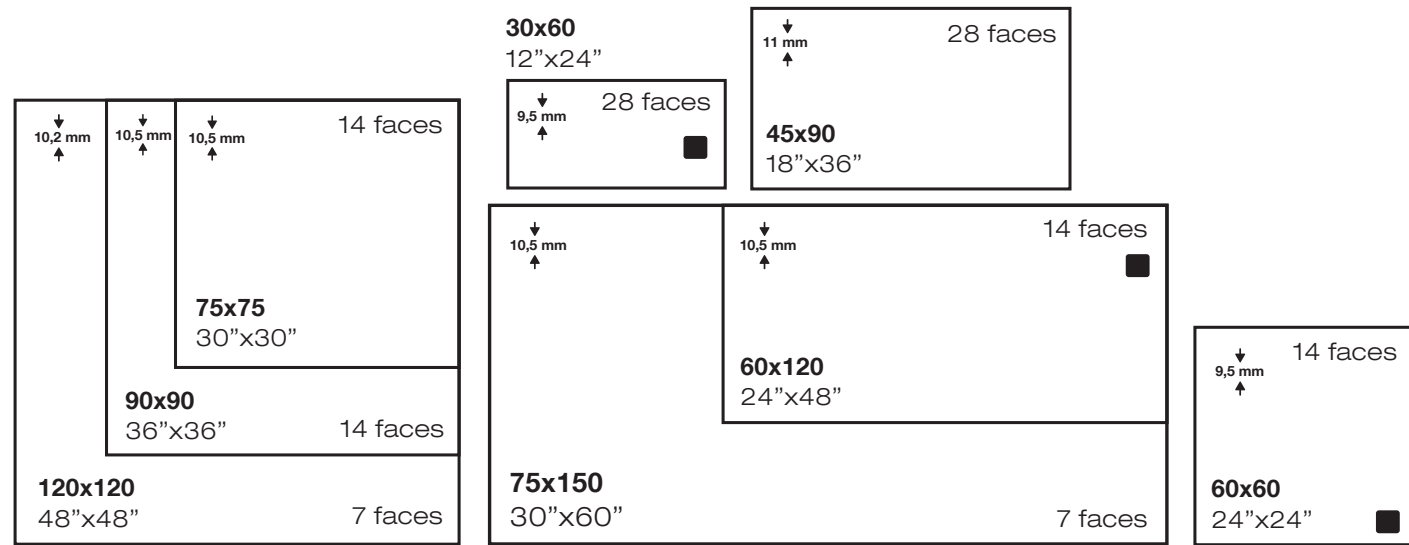

## PACKING & SPECIAL PIECES

	Pc/Cj	M2/Cj	Cj/PI	M2/PI	Kg/Cj	Kg/PI
30x60	7	1,26	40	50,4	24,1	984
45x90	3	1,21	44	53,24	28,7	1282,8
60x60	4	1,44	30	43,2	30	920
75x75	3	1,69	30	50,7	41,2	1256
90x90	2	1,62	27	43,74	40	1100
60x120	2	1,44	32	46,08	34,5	1124
120x120	1	1,44	36	51,84	36,36	1328,96
75x150	1	1,16	40	45,2	28	1140

	Pulido	Mate
30x60	MP124	MP120
45x90	MP310	-
60x60	MP174	MP175
75x75	MP192	-
90x90	MP204	-
60x120	MP323	MP320
120x120	MP333	-
75x150	MP343	-

Ver página 582  
 See page 582



Golden 60x120 / 24"x48"







kendall

Kendall 120x120 / 48"x48"



# kendall



pavimento \_ porcelánico \_ pulido \_ rectificado  
 floor tile \_ porcelain \_ polished \_ rectified



**Serie también disponible en mate.**

Series also available in matt.

Série également disponible en mat.

Serie auch in matt erhältlich.

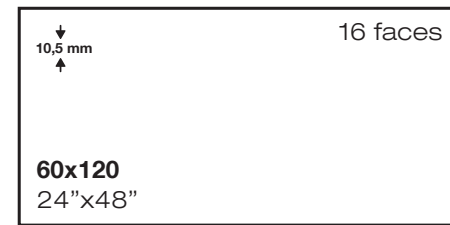
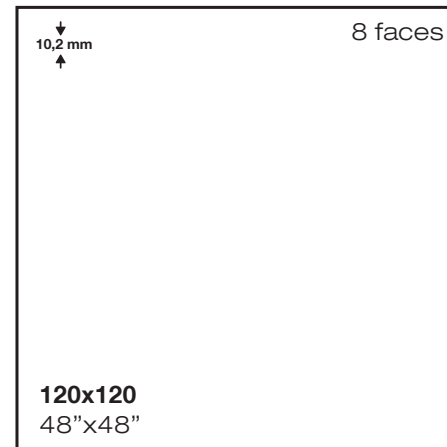

## PACKING & SPECIAL PIECES

	Pc/Cj	M2/Cj	Cj/PI	M2/PI	Kg/Cj	Kg/PI
<b>60x120</b>	2	1,44	32	46,08	34,5	1124
<b>120x120</b>	1	1,44	36	51,84	36,36	1328,96

	Pulido	Mate
<b>60x120</b>	MP323	MP320
<b>120x120</b>	MP333	MP330

**Ver página 582**  
See page 582

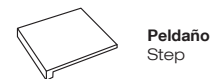

Kendall mate 60x120 / 24"x48"







kristen

Kristen 120x120 / 48"x48"



# kristen



pavimento \_ porcelánico \_ pulido \_ rectificado  
 floor tile \_ porcelain \_ polished \_ rectified



Serie también disponible en mate.  
 Series also available in matt.  
 Série également disponible en mat.  
 Serie auch in matt erhältlich.

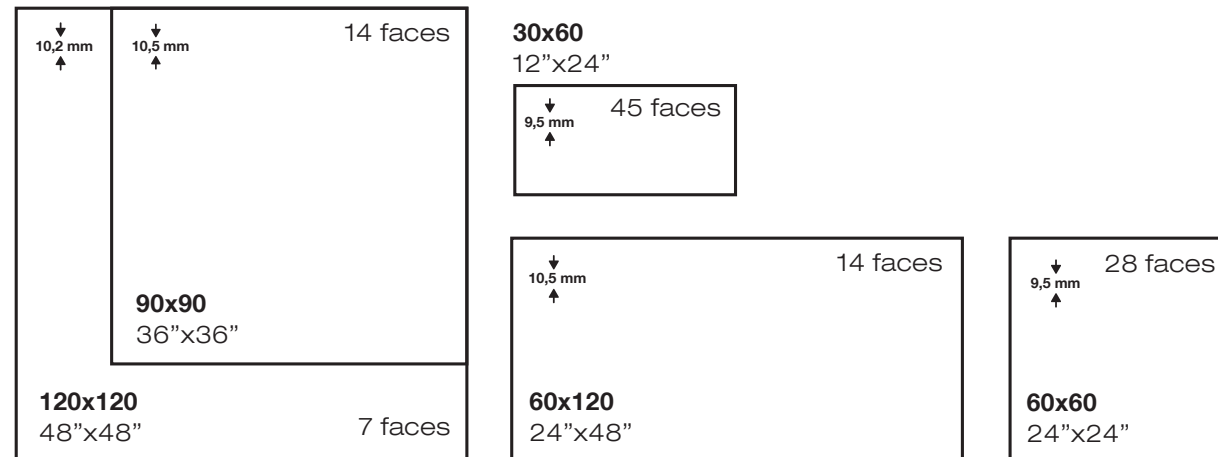

## PACKING & SPECIAL PIECES

	Pc/Cj	M2/Cj	Cj/PI	M2/PI	Kg/Cj	Kg/PI
<b>60x120</b>	2	1,44	32	46,08	34,5	1124
<b>120x120</b>	1	1,44	36	51,84	36,36	1328,96

	Pulido	Mate
<b>60x120</b>	MP323	MP320
<b>120x120</b>	MP333	MP330

**Ver página 582**  
 See page 582



**Rodapié**  
 Skirting

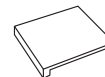

**Peldaño**  
 Step

**Ktisten mate 60x120 / 24"x48"**

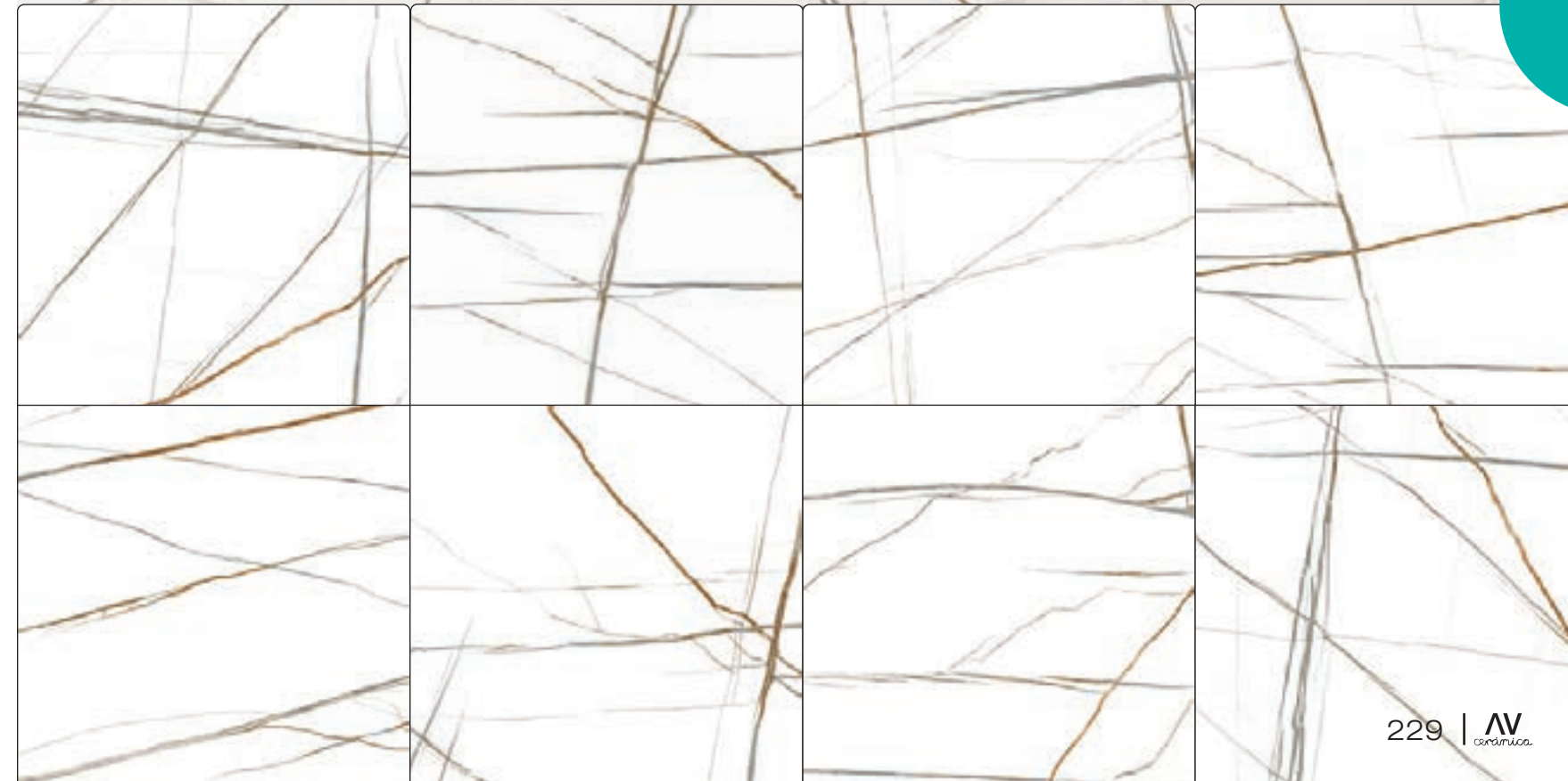





lance

Lance 60x120 / 24"x48" \_ Taiga noce 20x120 / 8"x48"



# lance



pavimento \_ porcelánico \_ pulido \_ rectificado  
 floor tile \_ porcelain \_ polished \_ rectified

**Serie también disponible en mate.**  
 Series also available in matt.  
 Série également disponible en mat.  
 Serie auch in matt erhältlich.

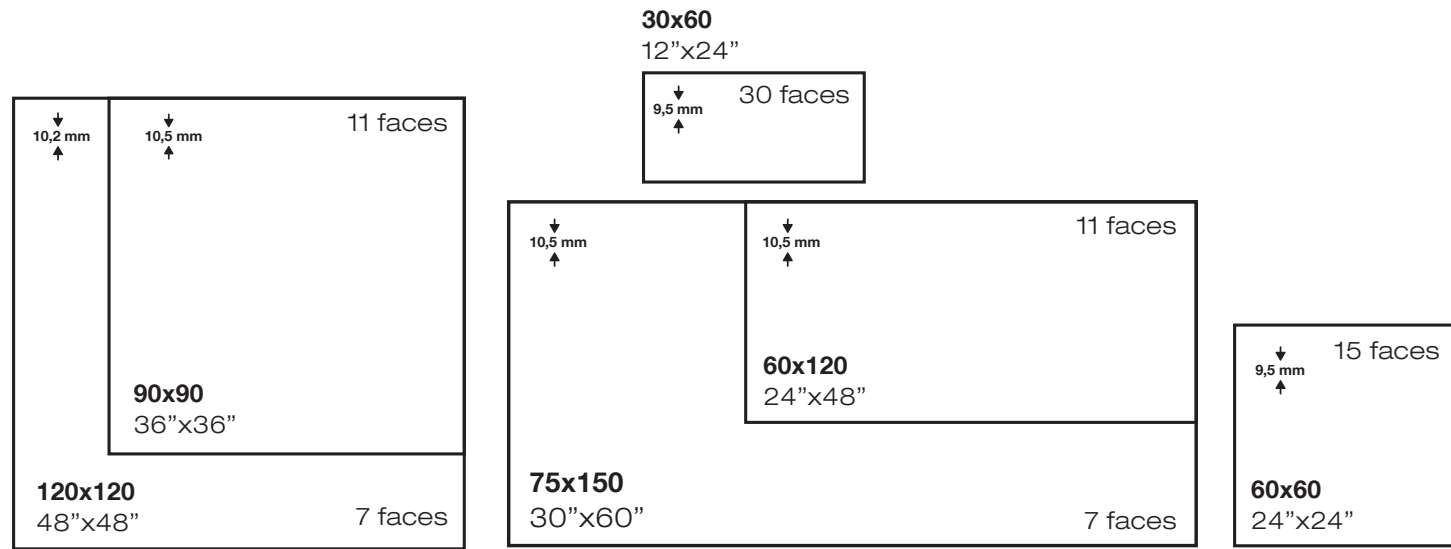

## PACKING & SPECIAL PIECES

	Pc/Cj	M2/Cj	Cj/PI	M2/PI	Kg/Cj	Kg/PI
<b>30x60</b>	7	1,26	40	50,4	24,1	984
<b>60x60</b>	4	1,44	30	43,2	30	920
<b>90x90</b>	2	1,62	27	43,74	40	1100
<b>60x120</b>	2	1,44	32	46,08	34,5	1124
<b>120x120</b>	1	1,44	36	51,84	36,36	1328,96
<b>75x150</b>	1	1,16	40	45,2	28	1140

	Pulido	Mate
<b>30x60</b>	MP124	MP120
<b>60x60</b>	MP174	MP170
<b>90x90</b>	MP204	MP207
<b>60x120</b>	MP323	MP320
<b>120x120</b>	MP333	MP330
<b>75x150</b>	MP343	MP340

Ver página 582  
 See page 582



Lance mate 120x120 / 48"x48"

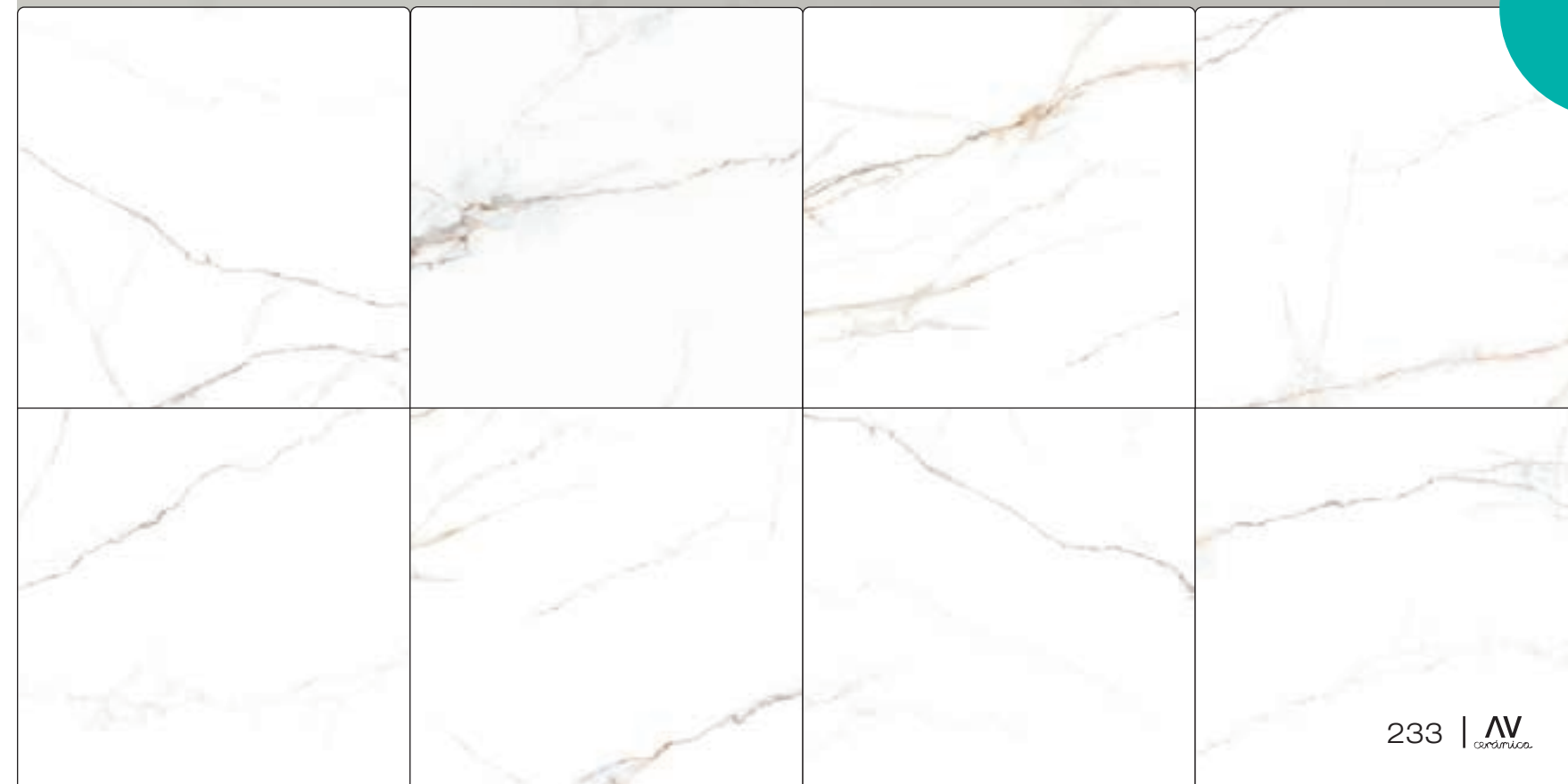





lindsay

Lindsay 120x120 / 48"x48"



# lindsay



pavimento \_ porcelánico \_ pulido \_ rectificado  
 floor tile \_ porcelain \_ polished \_ rectified



**Serie también disponible en mate.**  
 Series also available in matt.  
 Série également disponible en mat.  
 Serie auch in matt erhältlich.

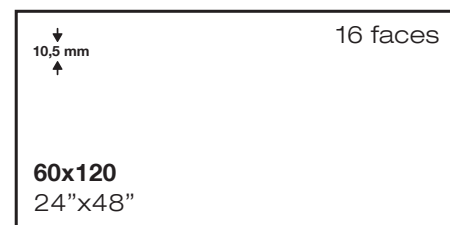
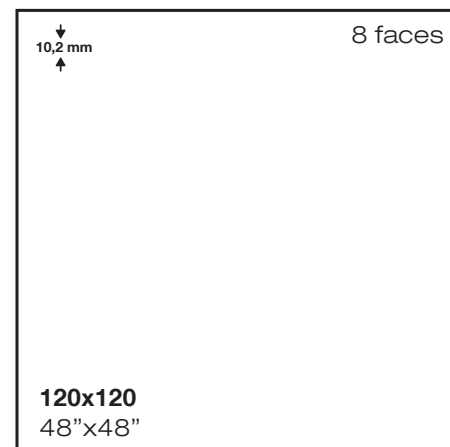

## PACKING & SPECIAL PIECES

	Pc/Cj	M2/Cj	Cj/PI	M2/PI	Kg/Cj	Kg/PI
<b>60x120</b>	2	1,44	32	46,08	34,5	1124
<b>120x120</b>	1	1,44	36	51,84	36,36	1328,96

	Pulido	Mate
<b>60x120</b>	MP323	MP320
<b>120x120</b>	MP333	MP330

**Ver página 582**  
 See page 582

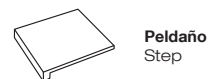

Lindsay mate 120x120 / 48"x48" \_ Cima negro 13x15 / 5"x6"

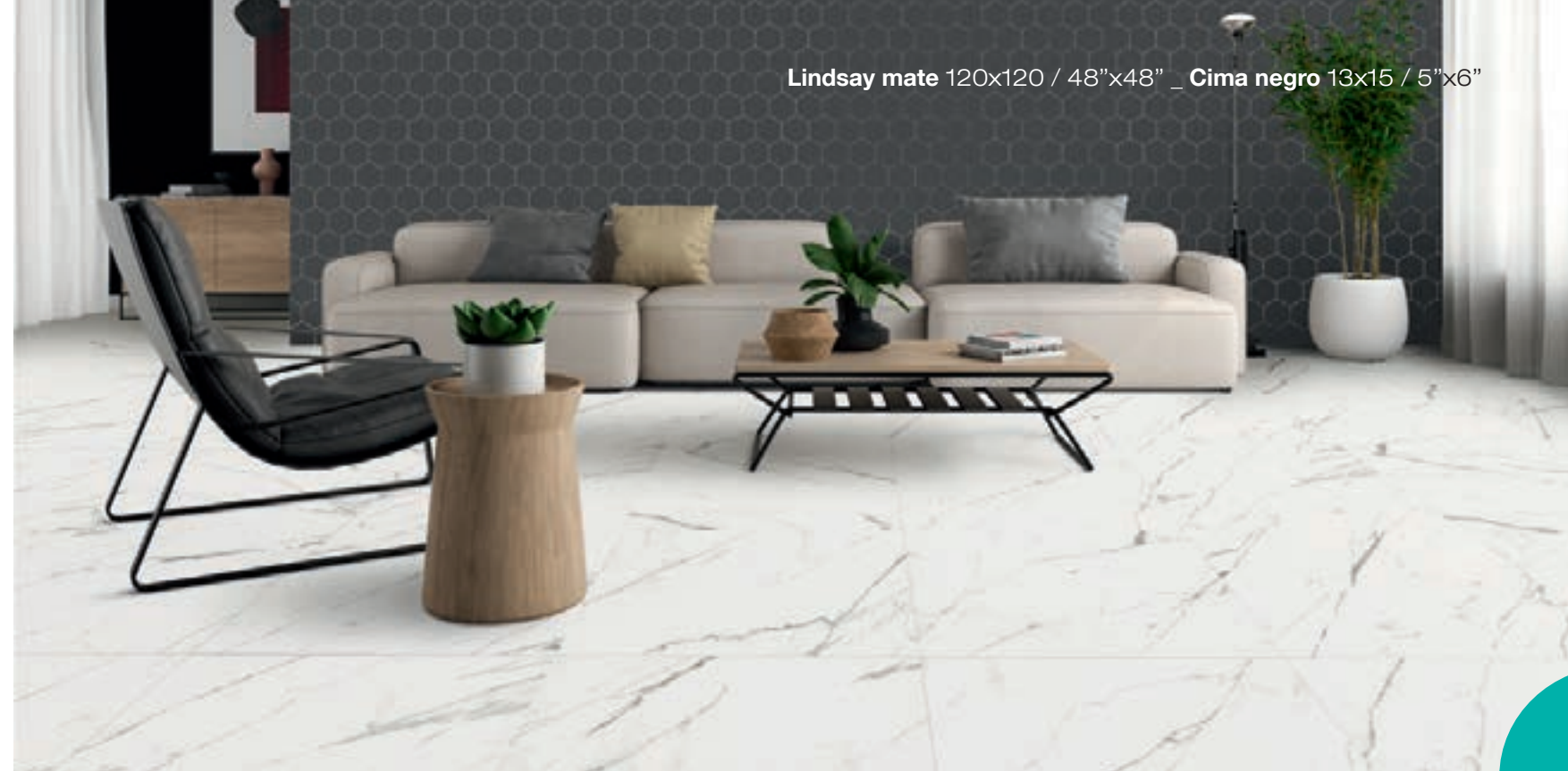





lugano

Lugano marfil 60x120 / 24"x48"



# Lugano



pavimento \_ porcelánico \_ pulido \_ rectificado  
 floor tile \_ porcelain \_ polished \_ rectified

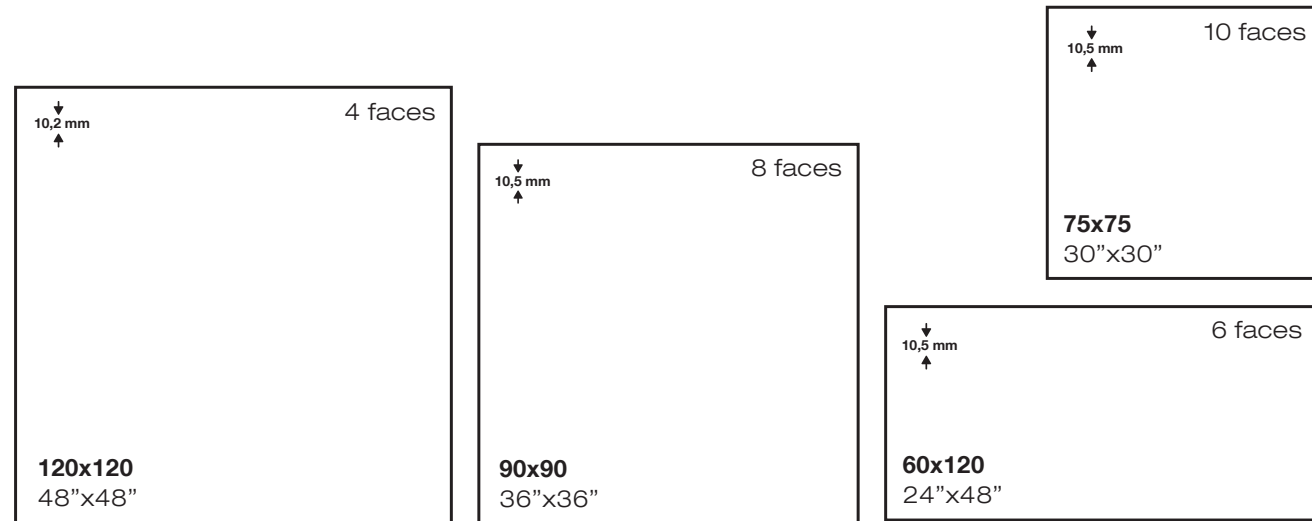

Lugano marfil 75x75 / 30"x30"



## PACKING & SPECIAL PIECES

	Pc/Cj	M2/Cj	Cj/PI	M2/PI	Kg/Cj	Kg/PI
<b>75x75</b>	3	1,69	30	50,7	41,2	1256
<b>90x90</b>	2	1,62	27	43,74	40	1100
<b>60x120</b>	2	1,44	32	46,08	34,5	1124
<b>120x120</b>	1	1,44	36	51,84	36,36	1328,96

	Pulido
<b>75x75</b>	MP192
<b>90x90</b>	MP204
<b>60x120</b>	M323
<b>120x120</b>	MP333

Ver página 582  
 See page 582

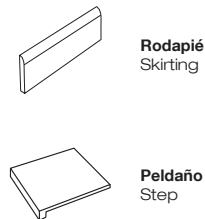

**Rodapié**  
 Skirting

**Peldaño**  
 Step





Marmo perla 120x120 / 48"x48"



marmo



# marmo



pavimento \_ porcelánico \_ pulido \_ rectificado  
 floor tile \_ porcelain \_ polished \_ rectified



**Serie también disponible en mate excepto en 75x150.**  
 Series also available in matt except in 75x150.  
 Série également disponible en mat sauf en 75x150.  
 Serie auch in matt erhältlich außer in 75x150.

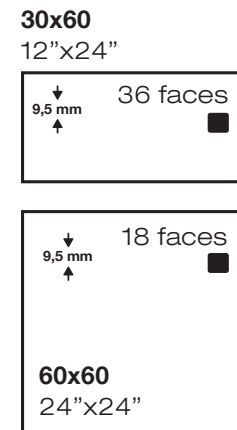
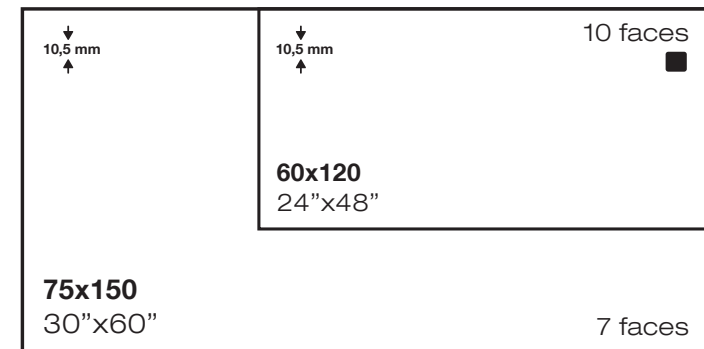
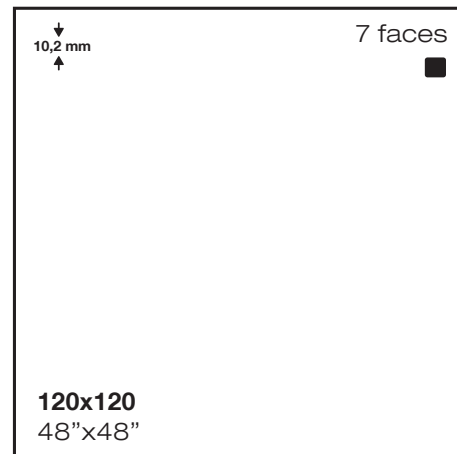

## PACKING & SPECIAL PIECES

	Pc/Cj	M2/Cj	Cj/PI	M2/PI	Kg/Cj	Kg/PI
<b>30x60</b>	7	1,26	40	50,4	24,1	984
<b>60x60</b>	4	1,44	30	43,2	30	920
<b>60x120</b>	2	1,44	32	46,08	34,5	1124
<b>120x120</b>	1	1,44	36	51,84	36,36	1328,96
<b>75x150</b>	1	1,16	40	45,2	28	1140

	Pulido	Mate
<b>30x60</b>	MP124	MP120
<b>60x60</b>	MP174	MP175
<b>60x120</b>	MP323	MP320
<b>120x120</b>	MP333	MP330
<b>75x150</b>	MP343	-

**Ver página 582**  
 See page 582



**Rodapié**  
 Skirting



**Peldaño**  
 Step

Marmo white 120x120 / 48"x48"







*Orix*

orix

**Orix marfil 90x90 / 36"x36"**



orix



pavimento \_ porcelánico \_ pulido \_ rectificado  
 floor tile \_ porcelain \_ polished \_ rectified

Orix perla 90x90 / 36"x36"

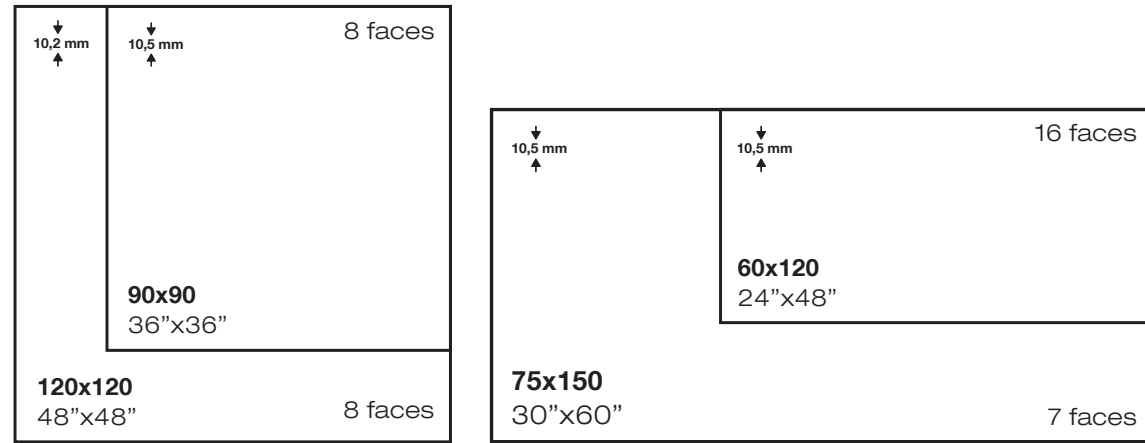

PACKING & SPECIAL PIECES

	Pc/Cj	M2/Cj	Cj/PI	M2/PI	Kg/Cj	Kg/PI
90x90	2	1,62	27	43,74	40	1100
60x120	2	1,44	32	46,08	34,5	1124
120x120	1	1,44	36	51,84	36,36	1328,96
75x150	1	1,16	40	45,2	28	1140

	Pulido
90x90	MP204
60x120	MP323
120x120	MP333
75x150	MP343

Ver página 582  
 See page 582



Rodapié  
 Skirting



Peldaño  
 Step





pol. calhea

Pol. Calhea 120x120 / 48"x48" \_ Tabil light 20x120 / 8"x48"



# pol. calhea



pavimento \_ porcelánico \_ pulido \_ rectificado  
 floor tile \_ porcelain \_ polished \_ rectified

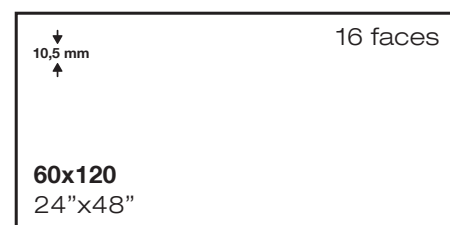
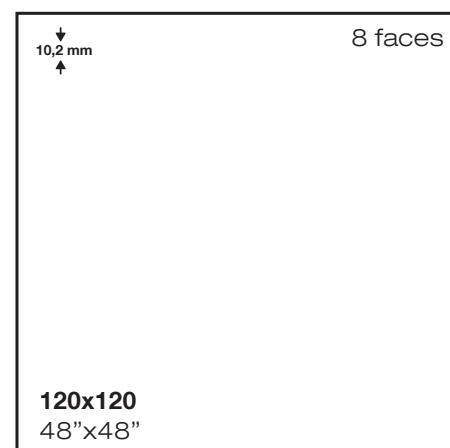

## PACKING & SPECIAL PIECES

	Pc/Cj	M2/Cj	Cj/PI	M2/PI	Kg/Cj	Kg/PI
<b>60x120</b>	2	1,44	32	46,08	34,5	1124
<b>120x120</b>	1	1,44	36	51,84	36,36	1328,96

	Pulido
<b>60x120</b>	MP323
<b>120x120</b>	MP333

**Ver página 582**  
See page 582



Pol. Calhea 120x120 / 48"x48"







pulsar

Pulsar marfil 120x120 / 48"x48"



# pulsar



pavimento \_ porcelánico \_ pulido \_ rectificado  
 floor tile \_ porcelain \_ polished \_ rectified

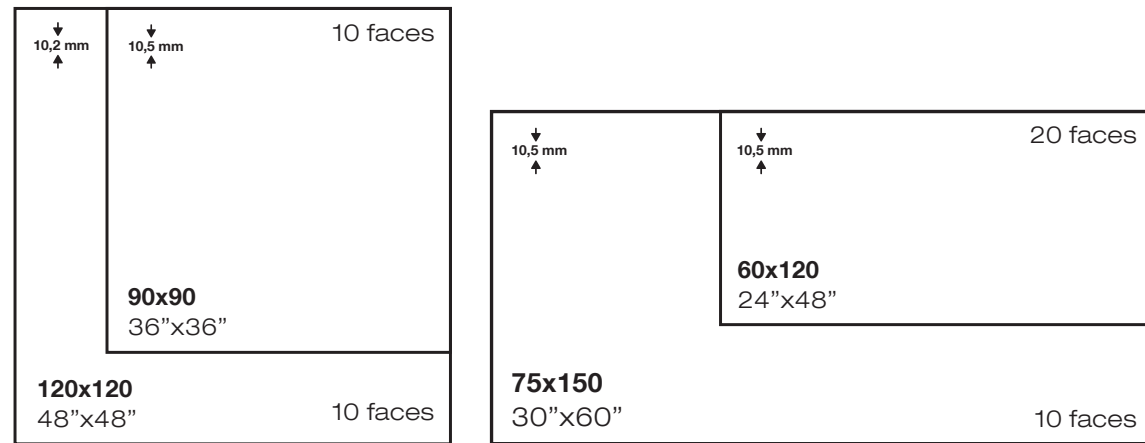

## PACKING & SPECIAL PIECES

	Pc/Cj	M2/Cj	Cj/PI	M2/PI	Kg/Cj	Kg/PI
<b>90x90</b>	2	1,62	27	43,74	40	1100
<b>60x120</b>	2	1,44	32	46,08	34,5	1124
<b>120x120</b>	1	1,44	36	51,84	36,36	1328,96
<b>75x150</b>	1	1,16	40	45,2	28	1140

	Pulido
<b>90x90</b>	MP204
<b>60x120</b>	MP323
<b>120x120</b>	MP333
<b>75x150</b>	MP343

**Ver página 582**  
See page 582



Pulsar gris 120x120 / 48"x48"







riola

Riola 75x150 / 30"x60"



# riola



pavimento \_ porcelánico \_ mate \_ rectificado  
 floor tile \_ porcelain \_ polished matt \_ rectified



**Serie también disponible en pulido pág. 188**  
 Series also available in polished p. 188  
 Série également disponible en poli p. 188  
 Serie auch in poliert erhältlich p. 188

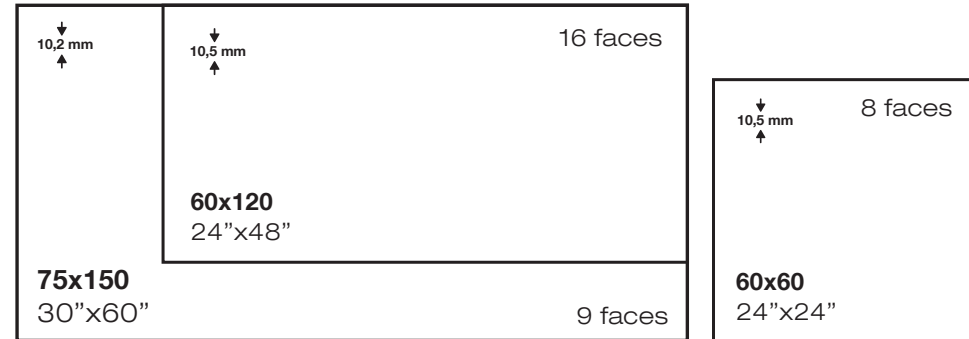

## PACKING & SPECIAL PIECES

	Pc/Cj	M2/Cj	Cj/PI	M2/PI	Kg/Cj	Kg/PI
<b>60x60</b>	4	1,44	30	43,2	30	920
<b>60x120</b>	2	1,44	32	46,08	34,5	1124
<b>75x150</b>	1	1,16	40	45,2	28	1140

	Mate
<b>60x60</b>	MP175
<b>60x120</b>	MP320
<b>75x150</b>	MP340

**Ver página 582**  
See page 582



**Rodapié**  
Skirting

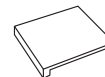

**Peldaño**  
Step

Riola 60x60 / 24"x24"

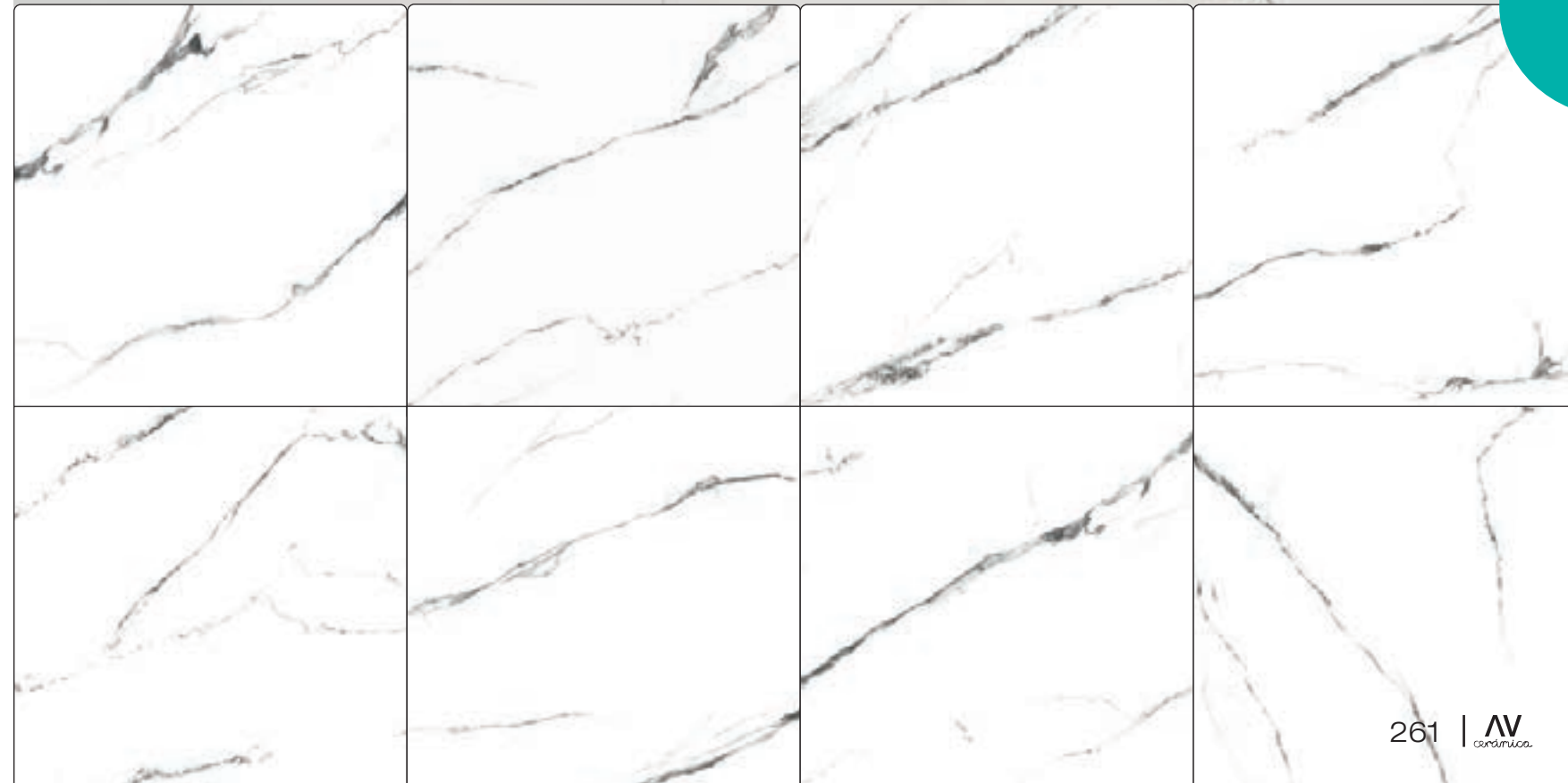





tekali

Tekali perla 45x90 / 18"x36"



# tekali



pavimento \_ porcelánico \_ pulido \_ rectificado  
 floor tile \_ porcelain \_ polished \_ rectified

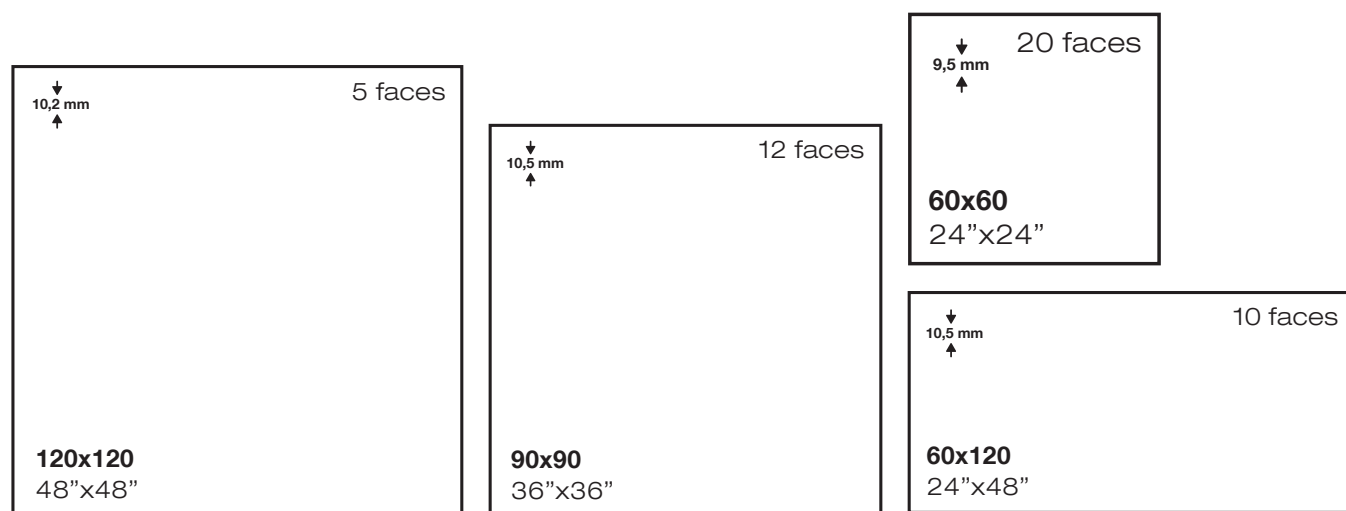

Tekali gris 120x120 / 48"x48"



## PACKING & SPECIAL PIECES

	Pc/Cj	M2/Cj	Cj/PI	M2/PI	Kg/Cj	Kg/PI
<b>60x60</b>	4	1,44	30	43,2	30	920
<b>90x90</b>	2	1,62	27	43,74	40	1100
<b>60x120</b>	2	1,44	32	46,08	34,5	1124
<b>120x120</b>	1	1,44	36	51,84	36,36	1328,96

	Pulido
<b>60x60</b>	MP174
<b>90x90</b>	MP204
<b>60x120</b>	MP323
<b>120x120</b>	MP333

Ver página 582  
 See page 582







tyra

Tyra 120x120 / 48"x48"



# tyra



pavimento \_ porcelánico \_ pulido \_ rectificado  
 floor tile \_ porcelain \_ polished \_ rectified



**Serie también disponible en mate.**

Series also available in matt.

Série également disponible en mat.

Serie auch in matt erhältlich.

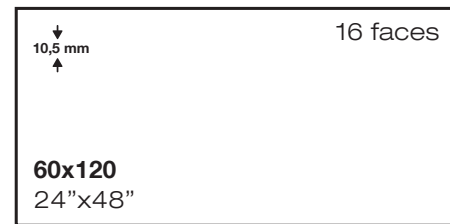
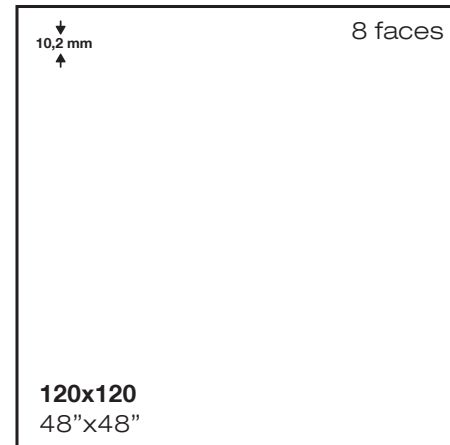

## PACKING & SPECIAL PIECES

	Pc/Cj	M2/Cj	Cj/PI	M2/PI	Kg/Cj	Kg/PI
<b>60x120</b>	2	1,44	32	46,08	34,5	1124
<b>120x120</b>	1	1,44	36	51,84	36,36	1328,96

	Pulido	Mate
<b>60x120</b>	MP323	MP320
<b>120x120</b>	MP333	MP330

**Ver página 582**  
 See page 582



Tyra mate 60x120 / 24"x48"







urli blue

Urli blue 120x120 / 48"x48" \_ Urli blue 30x60 / 12"x24" \_ Forest dark 20x120 / 8"x48"



# urli blue



pavimento \_ porcelánico \_ pulido \_ rectificado  
 floor tile \_ porcelain \_ polished \_ rectified



Serie también disponible en mate.  
 Series also available in matt.  
 Série également disponible en mat.  
 Serie auch in matt erhältlich.



**Malla Petru  
 Urli Blue**  
 P257  
 29x30 / 12"x12"

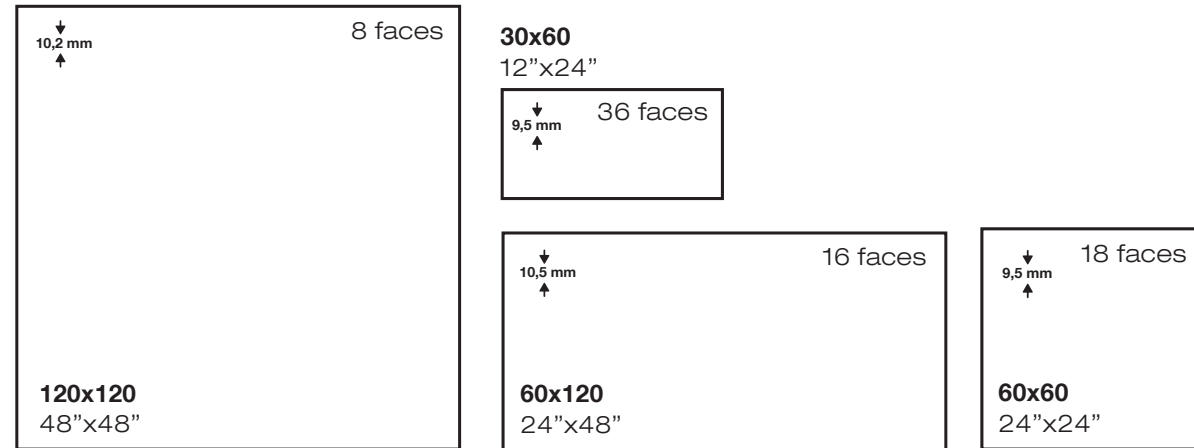

## PACKING & SPECIAL PIECES

	Pc/Cj	M2/Cj	Cj/PI	M2/PI	Kg/Cj	Kg/PI
<b>30x60</b>	7	1,26	40	50,4	24,1	984
<b>60x60</b>	4	1,44	30	43,2	30	920
<b>60x120</b>	2	1,44	32	46,08	34,5	1124
<b>120x120</b>	1	1,44	36	51,84	36,36	1328,96

	Pulido	Mate
<b>30x60</b>	MP124	MP120
<b>60x60</b>	MP174	MP175
<b>60x120</b>	MP323	MP320
<b>120x120</b>	MP333	MP330

 **Ver página 582**  
 See page 582



**Rodapié**  
 Skirting

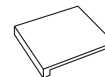

**Peldaño**  
 Step

Urli Blue mate 120x120 / 48"x48" \_ Chrome blue 60x120 / 24"x48"

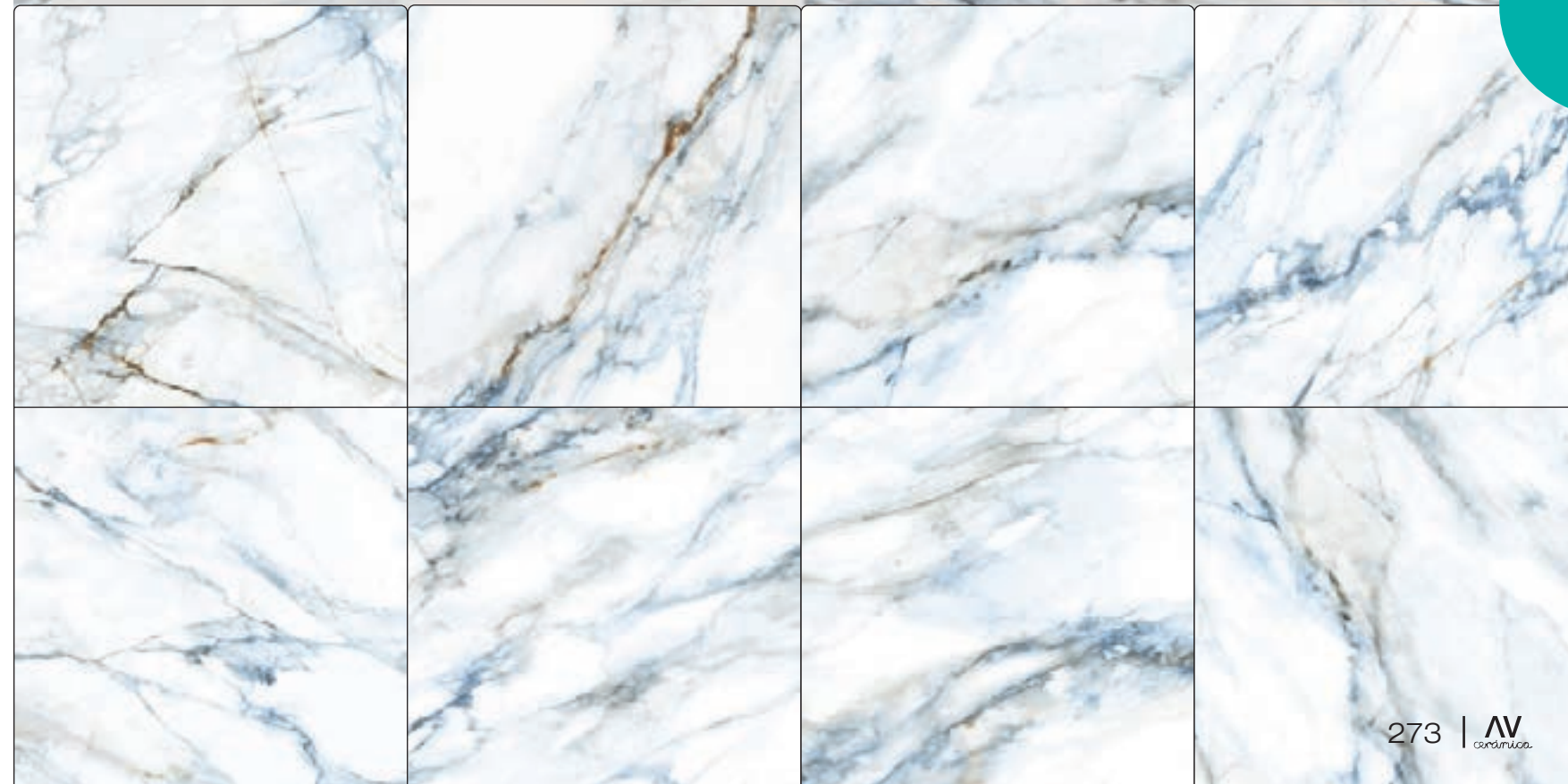





uyuni

Uyuni 60x120 / 24"x48" \_ Uyuni 120x120 / 48"x48"



# uyuni



pavimento \_ porcelánico \_ pulido \_ rectificado  
 floor tile \_ porcelain \_ polished \_ rectified



**Serie también disponible en mate.**

Series also available in matt.  
 Série également disponible en mat.  
 Serie auch in matt erhältlich.

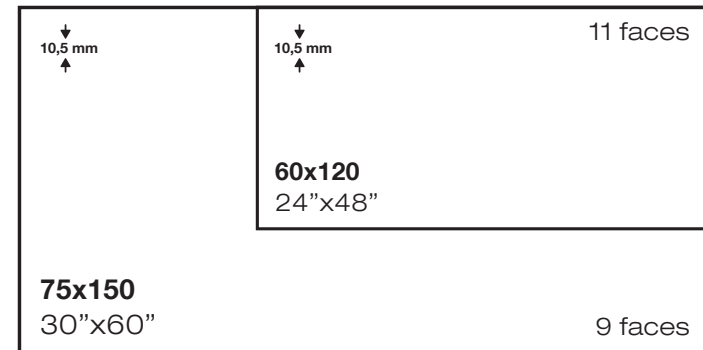
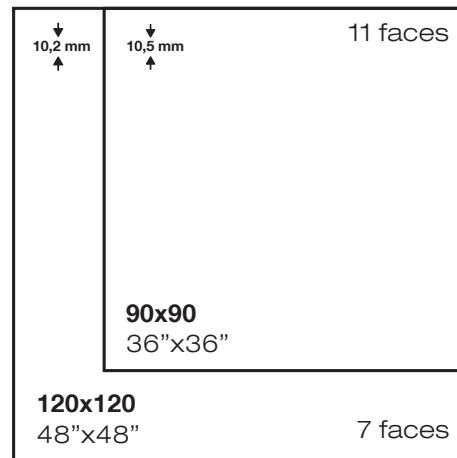

30x60  
12"x24"

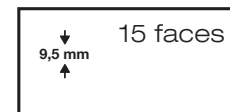
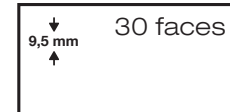

60x60  
24"x24"

## PACKING & SPECIAL PIECES

	Pc/Cj	M2/Cj	Cj/Pl	M2/Pl	Kg/Cj	Kg/Pl
30x60	7	1,26	40	50,4	24,1	984
60x60	4	1,44	30	43,2	30	920
90x90	2	1,62	27	43,74	40	1100
60x120	2	1,44	32	46,08	34,5	1124
120x120	1	1,44	36	51,84	36,36	1328,96
75x150	1	1,16	40	45,2	28	1140

	Pulido	Mate
30x60	MP124	MP126
60x60	MP174	MP175
90x90	MP204	MP207
60x120	MP323	MP320
120x120	MP333	MP330
75x150	MP343	MP340

Ver página 582  
 See page 582

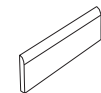

Rodapié  
 Skirting

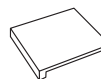

Peldaño  
 Step

Uyuni 60x120 / 24"x48"







viterbo

Viterbo blanco 120x120 / 48"x48"



# Viterbo



pavimento \_ porcelánico \_ pulido \_ rectificado  
 floor tile \_ porcelain \_ polished \_ rectified

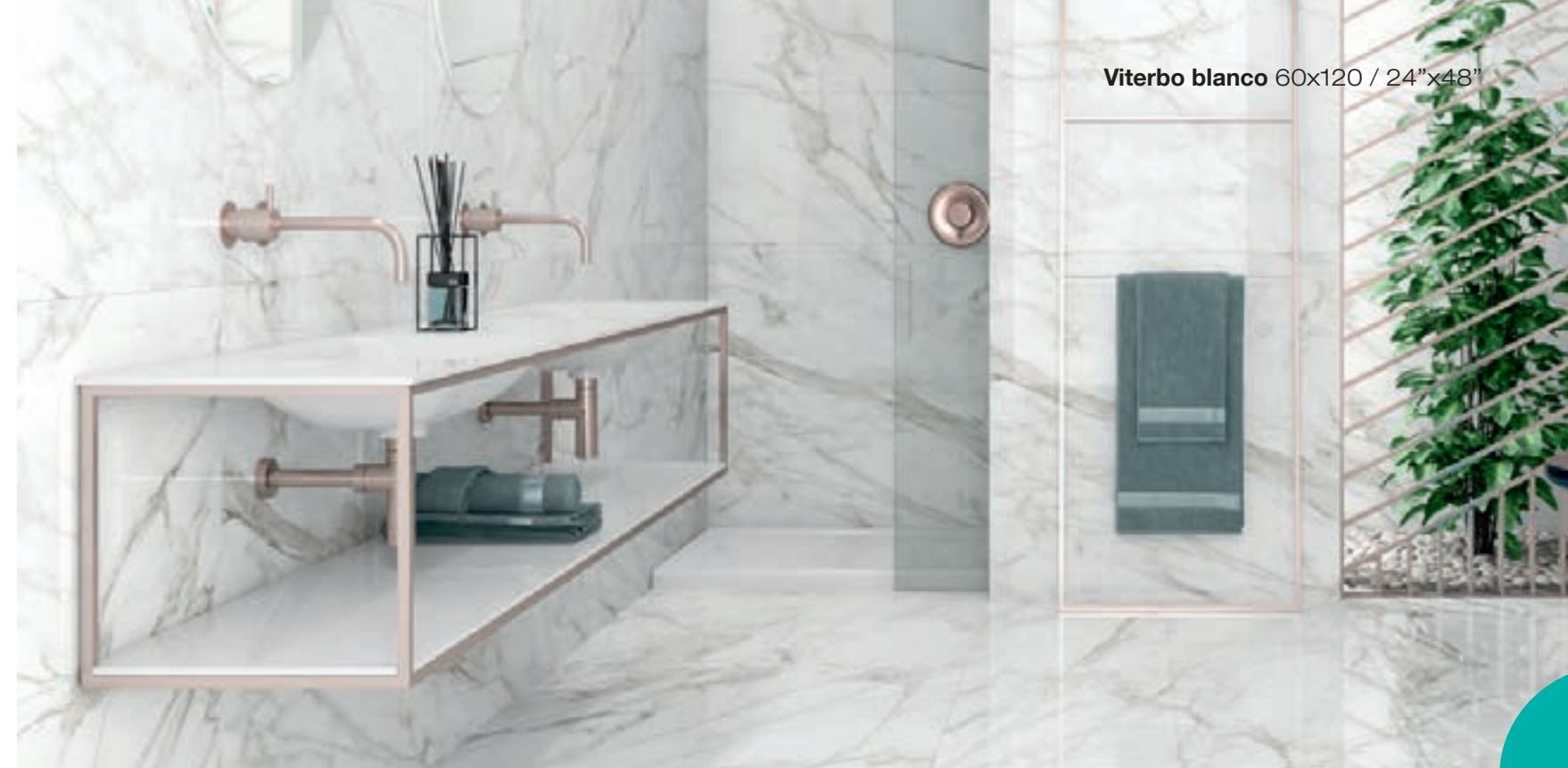
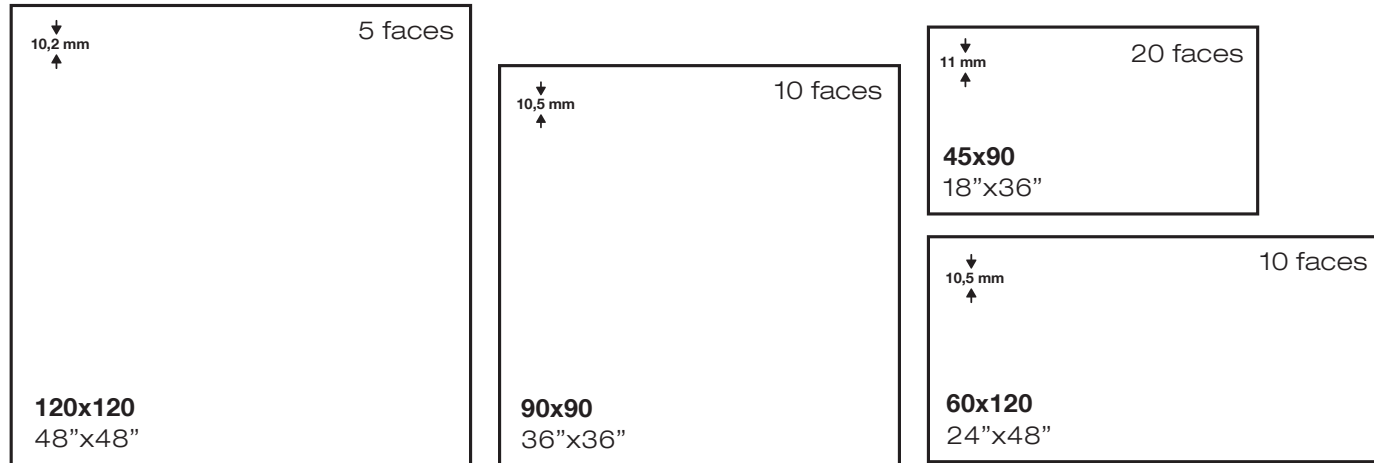

## PACKING & SPECIAL PIECES

	Pc/Cj	M2/Cj	Cj/PI	M2/PI	Kg/Cj	Kg/PI
45x90	3	1,21	44	53,24	28,7	1282,8
90x90	2	1,62	27	43,74	40	1100
60x120	2	1,44	32	46,08	34,5	1124
120x120	1	1,44	36	51,84	36,36	1328,96

	Pulido
45x90	MP310
90x90	MP204
60x120	MP323
120x120	MP333

Ver página 582  
 See page 582



Rodapié  
 Skirting

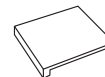

Peldaño  
 Step





zoey

Zoey mate 120x120 / 48"x48"



# zoey



pavimento \_ porcelánico \_ pulido \_ rectificado  
 floor tile \_ porcelain \_ polished \_ rectified



**Serie también disponible en mate.**

Series also available in matt.

Série également disponible en mat.

Serie auch in matt erhältlich.

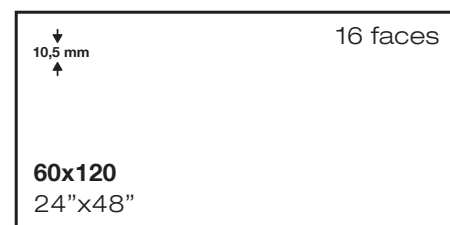
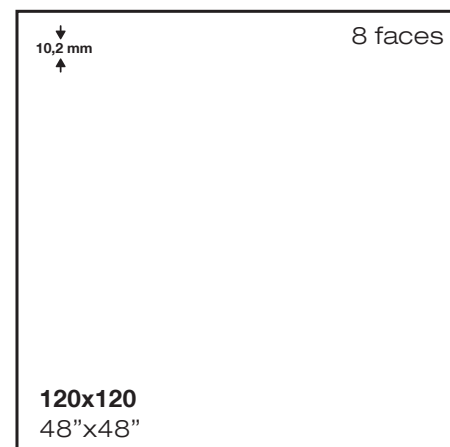

## PACKING & SPECIAL PIECES

	Pc/Cj	M2/Cj	Cj/PI	M2/PI	Kg/Cj	Kg/PI
60x120	2	1,44	32	46,08	34,5	1124
120x120	1	1,44	36	51,84	36,36	1328,96

	Pulido	Mate
60x120	MP323	MP320
120x120	MP333	MP330

**Ver página 582**  
See page 582

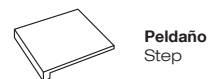

Zoey 120x120 / 48"x48"

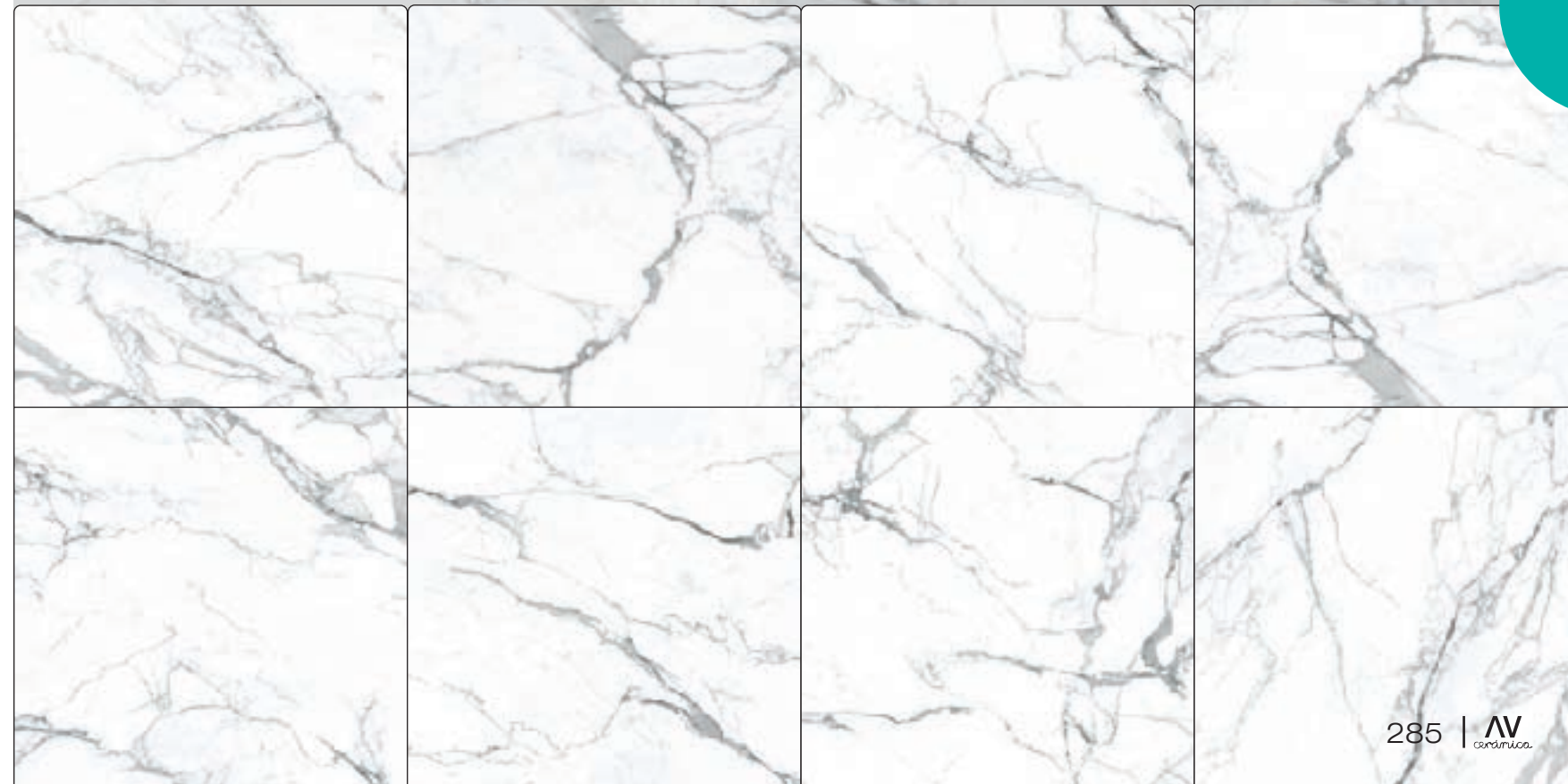





xtra

6 mm

## DE

Unser feinstes Porzellan mit einer Stärke von 6mm.

## FR

Notre porcelaine la plus fine d'une épaisseur de 6 mm.

## EN

Our finest porcelain with a thickness of 6mm.

## ES

Nuestros porcelánicos más finos con un espesor de 6mm.

cedar • tabil • arty • convec



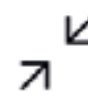

Presentamos nuestra nueva familia de porcelánico **XTRA /** extra **slim**, extra **resistente**, extra **flexible** y, sobre todo, extra **sostenible**.

 **¿Por qué extra slim?** Su espesor oscila entre los 6 mm. Esto la hace menos pesada y mejora su manejabilidad. Además, su espesor permite que se pueda aplicar en más campos a la hora de decorar y revestir proyectos.

 **¿Por qué extra flexible?** Es una pieza más fina y, por tanto, más elástica. Esto, junto a su poco peso, facilita la instalación. Convexidad y planitud.

 **¿Por qué extra resistente?** Destacamos su resistencia a la carga de rotura. Estas piezas están diseñadas y producidas con unas prensas especiales y tierras de vidrio evitando considerablemente roturas en las piezas.

 **¿Por qué extra sostenible?** Al tener un espesor tan fino podemos transportar más metros cuadrados en un mismo pallet. Esto abarata la logística y transporte, colaborando directamente con el respeto al medio ambiente mientras reducimos las emisiones de CO2 y residuos. Además, utilizamos menos materia prima y, por tanto, se necesita menos energía para producir estas piezas. Con esta nueva tipología de producto ahorraremos una gran cantidad de plástico, madera y CO2.

 **¿Por qué extra versátil?** Su reducido espesor permite mucha más versatilidad que cualquier otra pieza de espesor tradicional, tanto en la fabricación como en el transporte. El reducido peso facilita que las cajas puedan contener más piezas y por lo tanto más m2/cj.

 **¿Por qué extra ligero?** Su volumen es inferior a cualquier otra pieza, por lo que su peso se reduce considerablemente. Ello facilita muchos aspectos, como es el caso de la colocación en formatos más grandes.

Likewise, we present our new family of **XTRA** porcelain tiles: extra **slim**, extra **resistant**, extra **flexible** and, above all, extra **sustainable**.

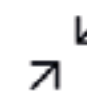
 **Why extra slim?** Its thickness varies between 6 mm. This makes it less heavy and improves its handling. In addition, its thickness allows it to be applied in more camps when it comes to decorating and coating projects.

 **Why extra flexible?** It is a thinner piece and, therefore, more elastic. This, together with its low weight, facilitates installation. Convexity and flatness.

 **Why extra resistant?** We highlight its resistance to breaking load. These pieces are designed and produced with special presses and glass grounds, considerably avoiding breakages in the pieces.

 **Why extra ecologic?** By having such a thin thickness, we can transport more square meters on the same pallet. This makes logistics and transport cheaper, collaborating directly with respect for the environment while reducing CO2 emissions and waste. In addition, we use less raw material and therefore less energy is needed to produce these parts. With this new type of product we will save a large amount of plastic, wood and CO2.

 **Why extra versatile?** Its reduced thickness allows much more versatility than any other piece of traditional thickness, both in manufacturing and in transport. The reduced weight makes it easier for the boxes to contain more pieces and therefore more m2/cj.

 **Why extra light?** Its volume is less than any other piece, so its weight is considerably reduced. This facilitates many aspects, such as placement in larger formats.





cedar

Cedar grey 20x120 / 8"x48"



# cedar



GRUPO  
Bla



Recomendable no colocar trabado a mitad de pieza / We do not recommend to lay the tiles brickbond (brick-jointed) halfway

20x120  
8"x48"

24 faces  
6 mm



Serie susceptible de tratamiento antideslizante bajo demanda.

Serie susceptible to anti-slip treatment on request.

Série sensible au traitement antidérapant sur demande.

Serie mit Antirutschbehandlung auf Anfrage.



cedar light grey



cedar natural



cedar medium

## PACKING & SPECIAL PIECES

	Pc/Cj	M2/Cj	Cj/Pl	M2/Pl	Kg/Cj	Kg/Pl
20x120	10	2,4	44	105,6	31	1384

	Cód.
20x120	MP400

Ver página 583  
See page 583



Rodapié  
Skirting



Peldaño  
Step



Cedar natural 20x120 / 8"x48"







tabil

Tabil dark 20x120 / 8"x48"



# tabil



GRUPO  
Bla



**Recomendable no colocar trabado a mitad de pieza** / We do not recommend to lay the tiles brickbond (brick-jointed) halfway

20x120  
8"x48"

24 faces  
6 mm



**Serie susceptible de tratamiento antideslizante bajo demanda.**

Series susceptible to anti-slip treatment on request.  
Série sensible au traitement antidérapant sur demande.  
Serie mit Antirutschbehandlung auf Anfrage.



tabil light



tabil natural



tabil dark

## PACKING & SPECIAL PIECES

	Pc/Cj	M2/Cj	Cj/Pl	M2/Pl	Kg/Cj	Kg/Pl
20x120	10	2,4	44	105,6	31	1384

	Cód.
20x120	MP400

**Ver página 583**  
See page 583



**Rodapié**  
Skirting

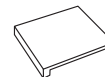

**Peldaño**  
Step

Tabil natural 20x120 / 8"x48"







arty

Arty greige 60x120 / 24"x48"



# arty



# xtra

↓  
6 mm  
↑

10 faces

**60x120**  
24"x48"



**Serie susceptible de tratamiento antideslizante bajo demanda.**  
 Series susceptible to anti-slip treatment on request.  
 Série sensible au traitement antidérapant sur demande.  
 Serie mit Antirutschbehandlung auf Anfrage.

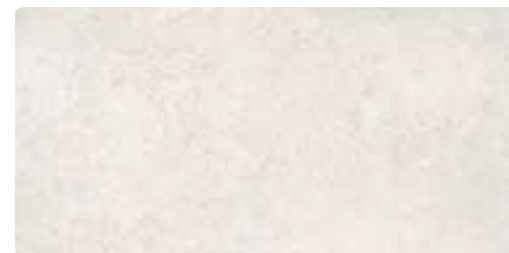

arty bone

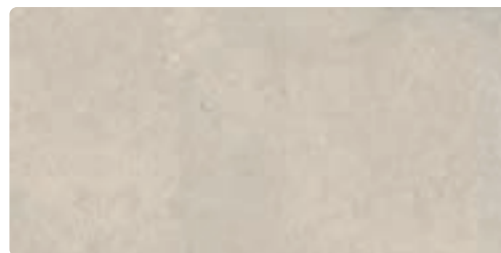

arty greige

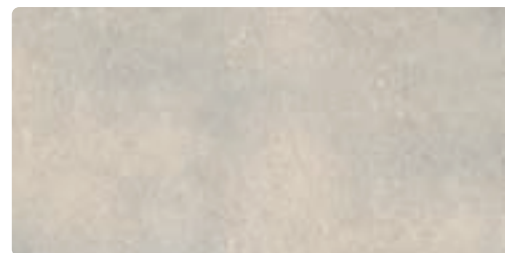

arty grey

## PACKING & SPECIAL PIECES

	Pc/Cj	M2/Cj	Cj/Pl	M2/Pl	Kg/Cj	Kg/Pl
<b>60x120</b>	3	2,16	38,8	69,12	108	1067,6

	Cód.
<b>60x120</b>	MP420

**Ver página 583**  
See page 583



**Rodapié**  
Skirting



**Peldaño**  
Step

Arty grey 60x120 / 24"x48"







convec

Convec dark 60x120 / 24"x48"



# convec





↓  
6 mm  
↑

10 faces

**60x120**  
24"x48"

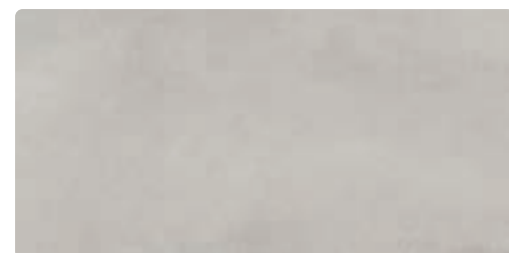

**Serie susceptible de tratamiento antideslizante bajo demanda.**  
 Series susceptible to anti-slip treatment on request.  
 Série sensible au traitement antidérapant sur demande.  
 Serie mit Antirutschbehandlung auf Anfrage.



convec light



convec medium

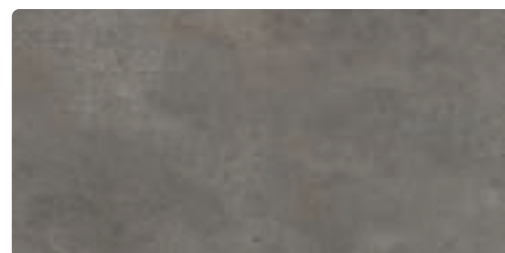

convec dark

## PACKING & SPECIAL PIECES

	Pc/Cj	M2/Cj	Cj/Pl	M2/Pl	Kg/Cj	Kg/Pl
<b>60x120</b>	3	2,16	38,8	69,12	108	1067,6

	Cód.
<b>60x120</b>	MP420

 **Ver página 583**  
See page 583



**Rodapié**  
Skirting



**Peldaño**  
Step

Convec light 60x120 / 24"x48"





white body

wall tile

## DE

Unsere weissscherbigen Wandfliesen machen jeden Raum zu einem einzigartigen.

## FR

Nos gammes de faiences en pâte blanche transformeront n'importe quel environnement en un espace unique.

## EN

Our combination of white body tile, the perfect outcome for unique spaces.

## ES

Nuestras gamas de pasta blanca convertirán cualquier ambiente en un espacio único.



# terranova



Terranova / Rlv Terranova 36x80 / 14"x32"

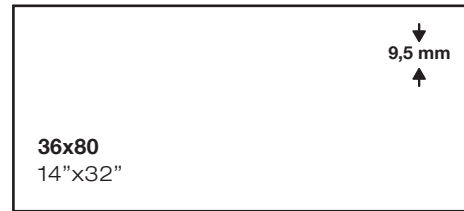

**PAVIMENTO RECOMENDADO**  
recommended floor tile

**METHOD** 60X60 cm

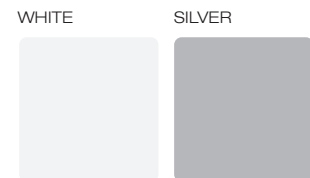

**PACKING & SPECIAL PIECES**

	Pc/Cj	M2/Cj	Cj/PI	M2/PI	Kg/Cj	Kg/PI
36x80	4	1,15	54	62,1	18,5	1019
	<b>Cód.</b>		<b>Cód.</b>			
<b>Terranova</b>	MB120	<b>Rlv Terranova</b>	MB125			
		<b>Rlv Indoc</b>	MB125			

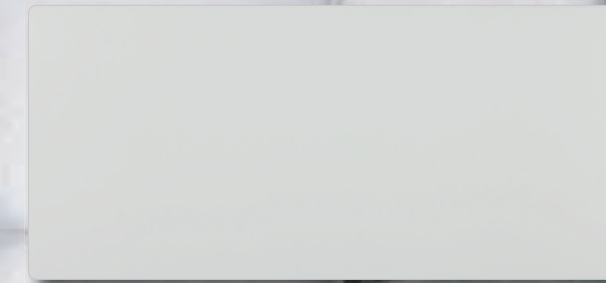

terranova

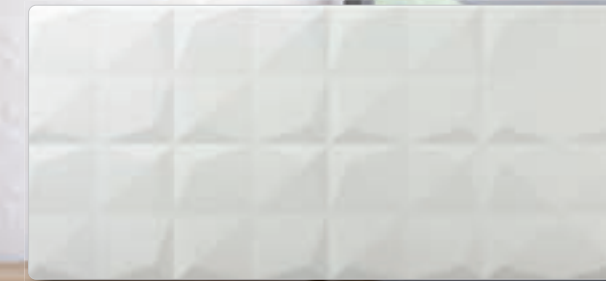

rlv terranova



rlv indoc





# Sandra



WB



GRUPO BIII



## PAVIMENTO RECOMENDADO

recommended floor tile

**METHOD** 60X60 cm

WHITE

SILVER

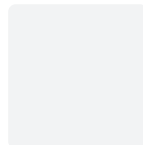

## PACKING & SPECIAL PIECES

	Pc/Cj	M2/Cj	Cj/PI	M2/PI	Kg/Cj	Kg/PI
<b>36x80</b>	4	1,15	54	62,1	18,5	1019

	Cód.	Cód.
<b>Sandra</b>	MB120	MB125
	<b>Rlv Sandra</b>	
	<b>Rlv Noon</b>	MB125

Sandra / Rlv Noon 36x80 / 14"x32" \_ Southrock perla 45x45 / 18"x18"

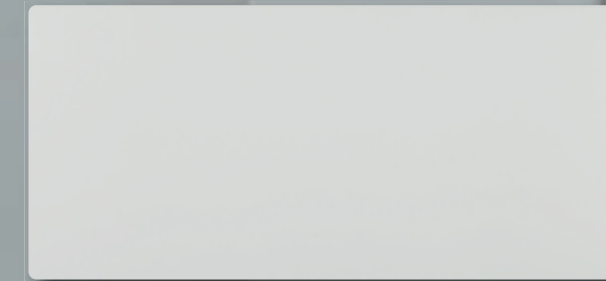

sandra

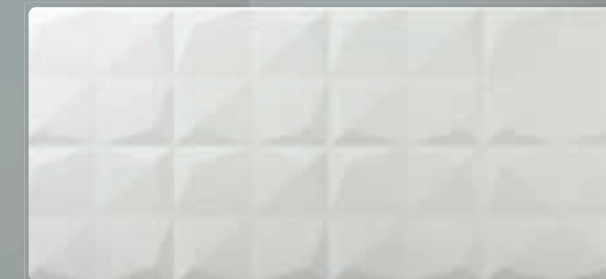

rlv sandra

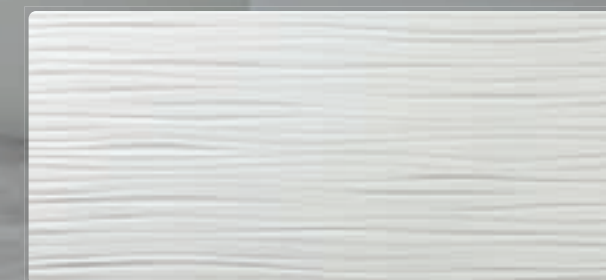

rlv noon



# ziro



WB



GRUPO BIII



**PAVIMENTO COORDINADO**  
coordinated floor tile

**ZIRO / 60X60 cm**

BLANCO

CREMA

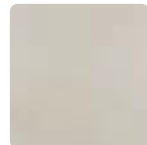
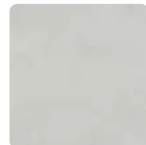

PERLA

GRIS

MARENGO

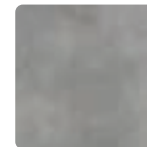
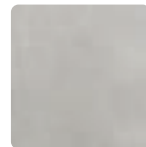

## PACKING & SPECIAL PIECES

	Pc/Cj	M2/Cj	Cj/PI	M2/PI	Kg/Cj	Kg/PI
36x80	4	1,15	54	62,1	18,5	1019

	Cód.	Cód.
Ziro	MB120	Rlv Kata
		MB125
	Dc Bree / Ergo	MB126

Ziro crema / Rlv Kata crema 36x80 / 14"x32" \_ Ziro crema 45x45 / 18"x18"

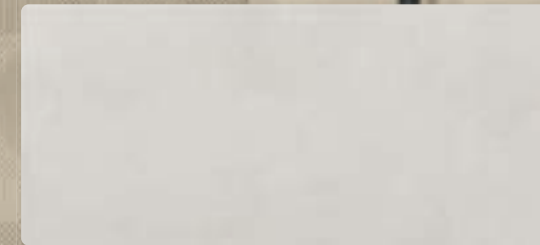

ziro blanco



rlv kata blanco

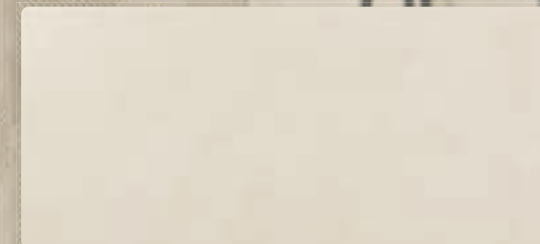

ziro crema



rlv kata crema



\*dc bree

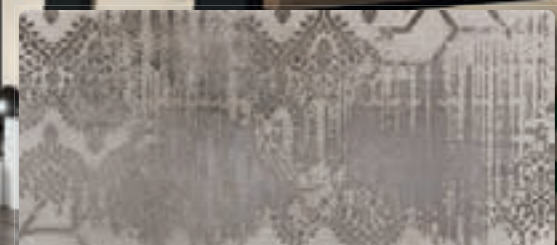

\*dc ergo

\* Diferentes diseños en una caja / Mixed designs in each box



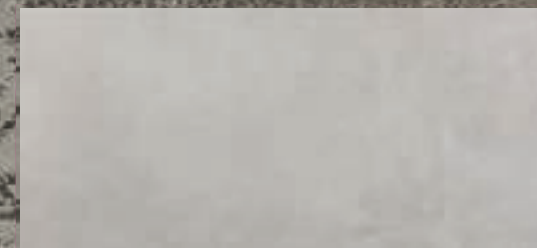

ziro perla



rlv kata perla

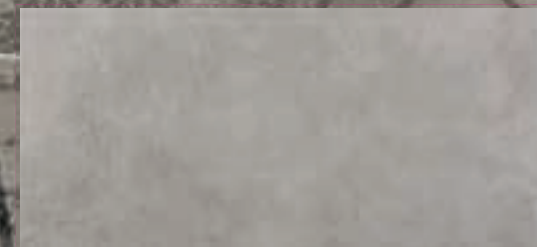

ziro gris

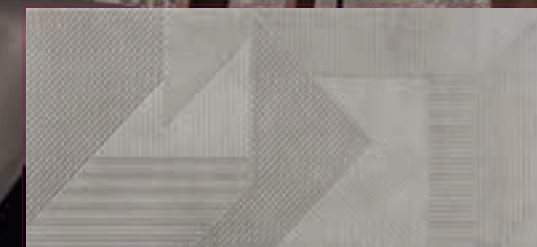

rlv kata gris



\*dc bree

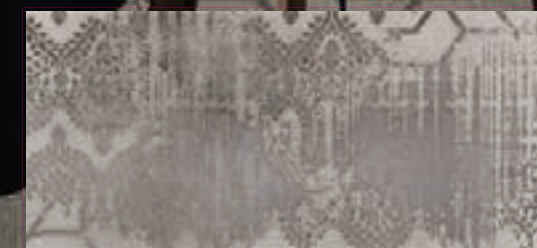

\*dc ergo

\* Diferentes diseños en una caja / Mixed designs in each box



# annie



Annie / Rlv Galagos mate 30x90 / 12"x36"



Serie también disponible en brillo p. 354  
 Series also available in gloss p. 354  
 Série également disponible en brillant p. 354  
 Serie auch in Glanz erhältlich p. 354



**PAVIMENTO RECOMENDADO**  
 recommended floor tile

**METHOD** 60X60 cm

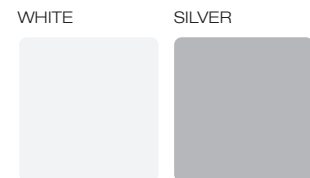

**PACKING & SPECIAL PIECES**

	Pc/Cj	M2/Cj	Cj/PI	M2/PI	Kg/Cj	Kg/PI
30x90	4	1,08	64	69,12	18,75	1220
30x90 Rlv	5	1,35	63	85,05	20,22	1293,86

	Cód.		Cód.
Annie	MB140	Rlv Galagos / Arad / Oradea	MB145
		Rlv Kross	MB145

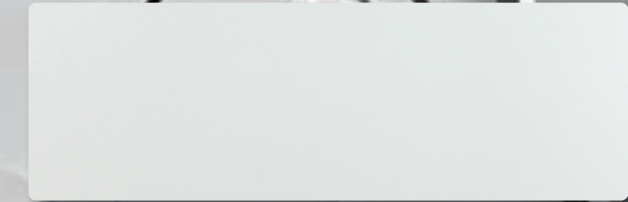

annie



rlv galagos mate

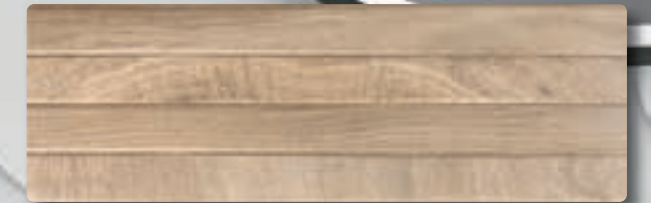

rlv kross haya



rlv oradea mate



rlv kross

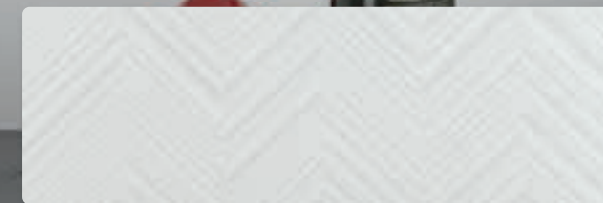

rlv arad mate



rlv kross gris



# aruma

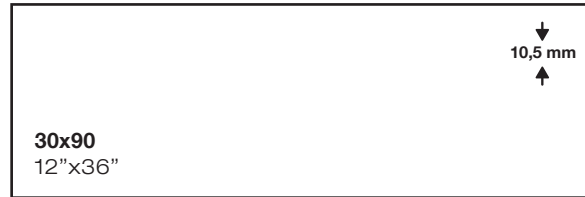

## PAVIMENTO COORDINADO

coordinated floor tile

ALLURE / 60X60 cm

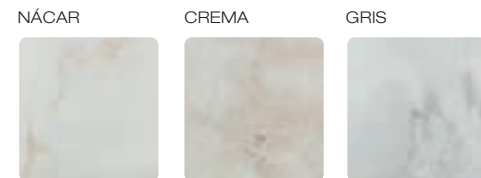

## PACKING & SPECIAL PIECES

	Pc/Cj	M2/Cj	Cj/PI	M2/PI	Kg/Cj	Kg/PI
30x90	4	1,08	64	69,12	18,75	1220
30x90 Rlv	5	1,35	63	85,05	20,22	1293,86

	Cód.	Cód.
Aruma	MB140	Rlv Aruma MB145
		Rlv Marmi MB145

Aruma crema / Rlv Marmi crema 30x90 / 12"x24"

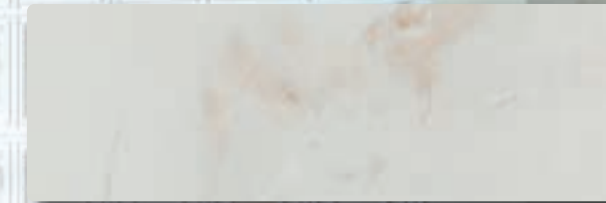

aruma nácar



rlv aruma nácar



aruma crema



rlv aruma crema

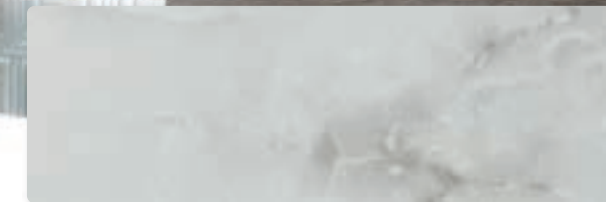

aruma gris

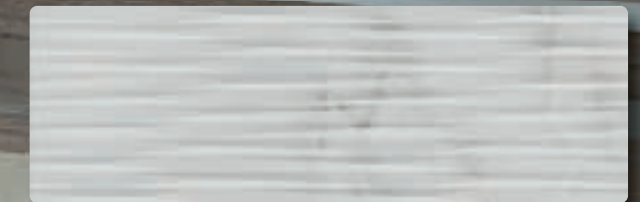

rlv aruma gris



rlv marmi crema



rlv marmi gris





# bellagio



**PAVIMENTO COORDINADO**  
coordinated floor tile

**BELLAGIO** 60X60 cm

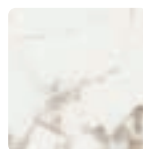

## PACKING & SPECIAL PIECES

	Pc/Cj	M2/Cj	Cj/PI	M2/PI	Kg/Cj	Kg/PI
<b>30x90</b>	4	1,08	64	69,12	18,75	1220
<b>30x90 Rlv</b>	5	1,35	63	85,05	20,22	1293,86

	Cód.		Cód.
<b>Bellagio</b>	MB140	<b>Rlv Bellagio</b>	MB145
		<b>Waves</b>	MB140

Bellagio / Rlv Bellagio 30x90 / 12"x36"



bellagio



rlv bellagio



bellagio waves



# calcare



## PAVIMENTO RECOMENDADO

recommended floor tile

### CALCARE / 90X90 cm

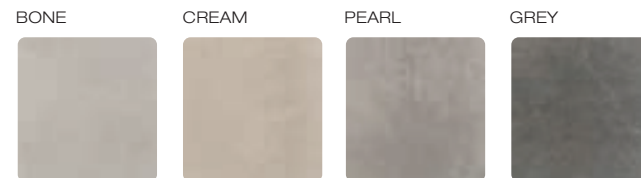

## PACKING & SPECIAL PIECES

	Pc/Cj	M2/Cj	Cj/PI	M2/PI	Kg/Cj	Kg/PI
30x90	4	1,08	64	69,12	18,75	1220
30x90 Rlv	5	1,35	63	85,05	20,22	1293,86

	Cód.	Cód.
Calcare	MB140	Rlv Boa / Enzo
		Dc Edith / Kovo
		MB145
		MB146

Calcare cream 30x90 / 12"x36" \_ Rlv Boa cream 30x90 / 12"x36" \_ Dc Edith cream 30x90 / 12"x36"

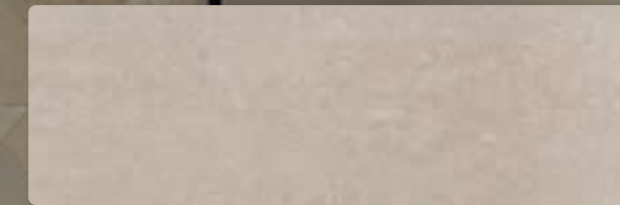
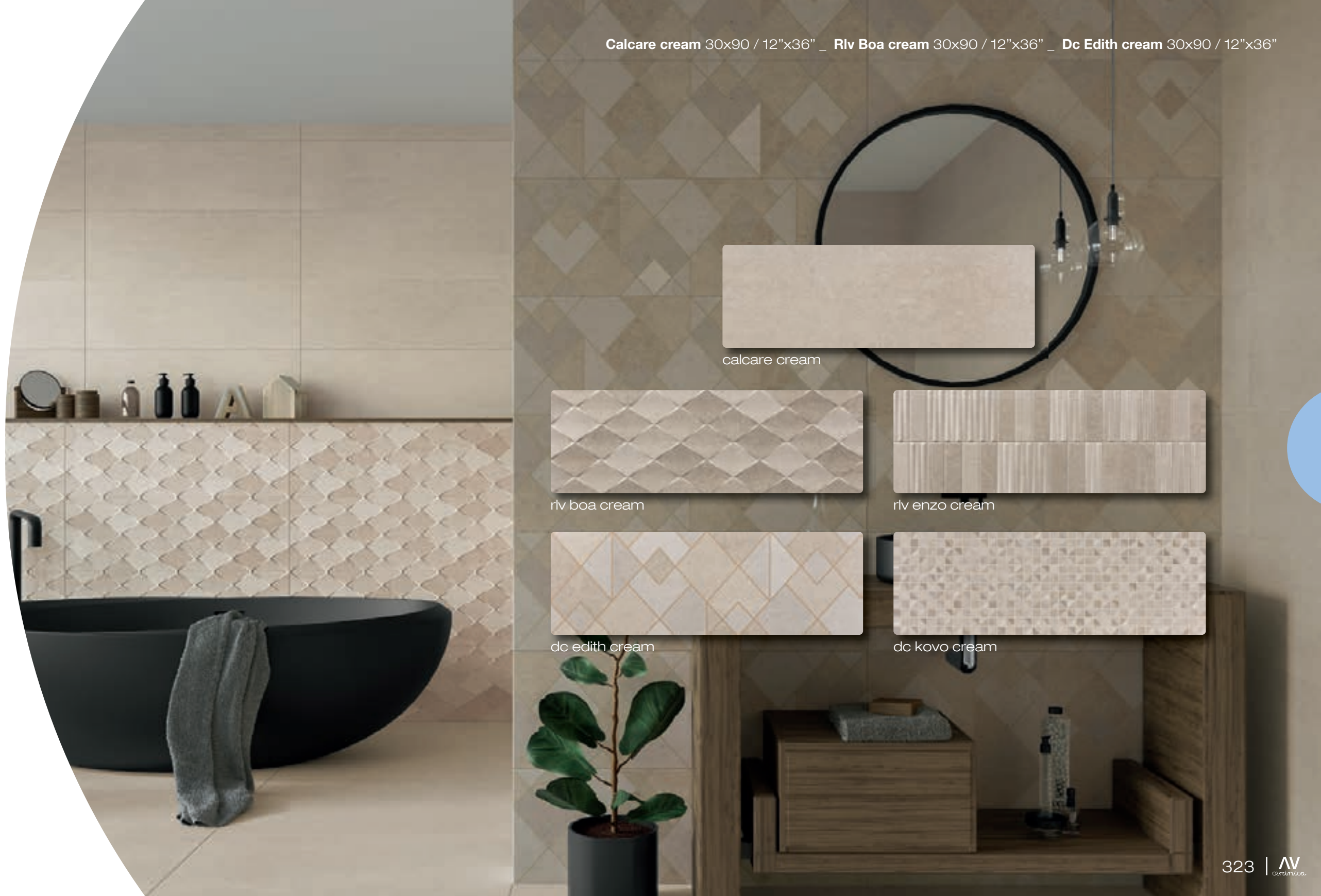

calcare cream



rlv boa cream



rlv enzo cream



dc edith cream



dc kovo cream



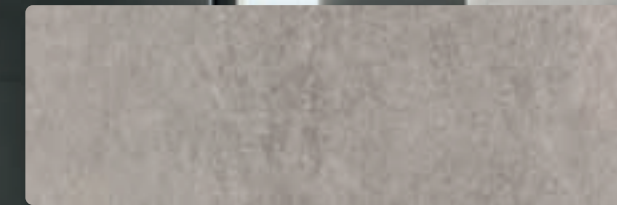

calcare pearl



rlv boa pearl



rlv enzo pearl



dc edith grey

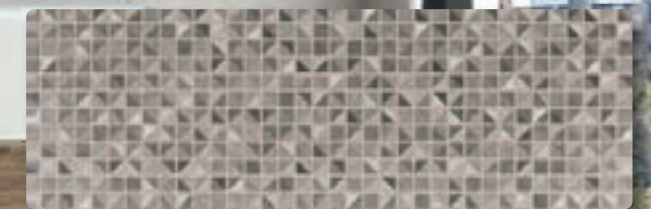

dc kovo grey



carra



Carra / Rlv Carra 30x90 / 12"x36"

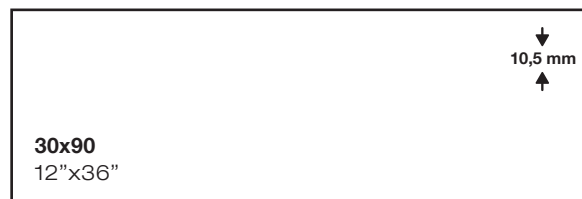

**Serie también disponible en brillo pág. 348**  
 Series also available in gloss p. 348  
 Série également disponible en brillant p. 348  
 Serie auch in Glanz erhältlich p. 348

**PAVIMENTO RECOMENDADO**  
recommended floor tile

**VALDIVIA / 60X60 cm**

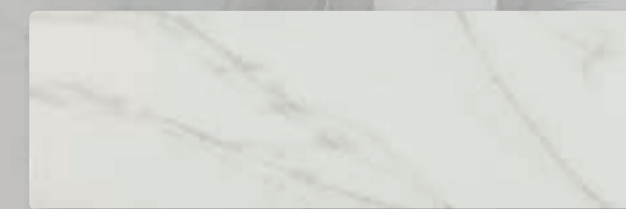

carra



rlv carra

**PACKING & SPECIAL PIECES**

	Pc/Cj	M2/Cj	Cj/PI	M2/PI	Kg/Cj	Kg/PI
<b>30x90</b>	4	1,08	64	69,12	18,75	1220
<b>30x90 Rlv</b>	5	1,35	63	85,05	20,22	1293,86

	Cód.		Cód.
<b>Carra</b>	MB140	<b>Rlv Carra</b>	MB145



# ceres



## PAVIMENTO RECOMENDADO

recommended floor tile

FANLO / 25X150 cm

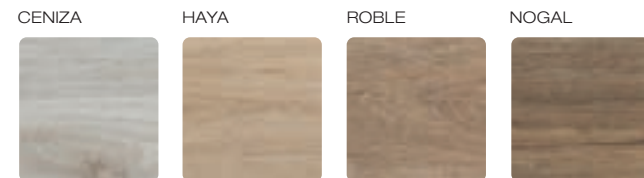

## PACKING & SPECIAL PIECES

	Pc/Cj	M2/Cj	Cj/PI	M2/PI	Kg/Cj	Kg/PI
30x90	4	1,08	64	69,12	18,75	1220
30x90 Rlv	5	1,35	63	85,05	20,22	1293,86

	Cód.	Cód.
Ceres	MB140	Rlv Hoyo
		MB145

Ceres beige / Rlv Hoyo beige 30x90 / 12"x36"

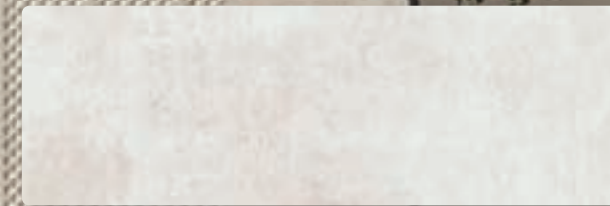

ceres blanco

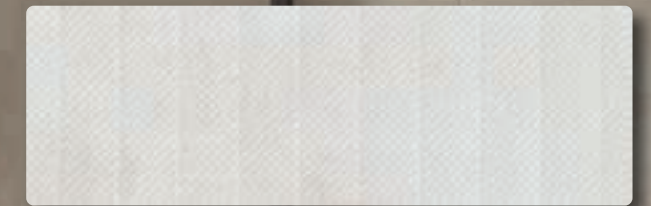

rlv hoyo blanco

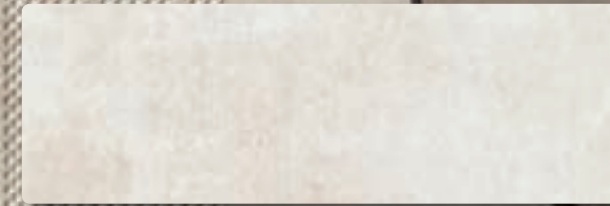

ceres beige

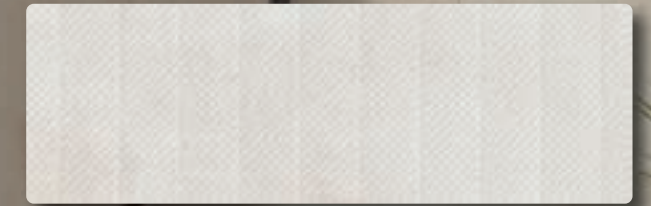

rlv hoyo beige



ceres óxido

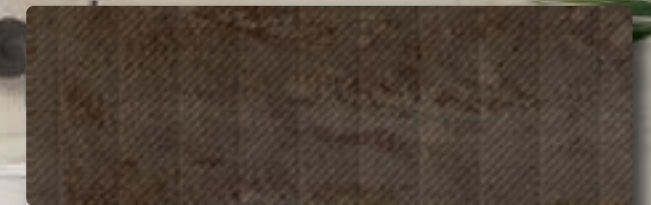

rlv hoyo óxido



ceres acero

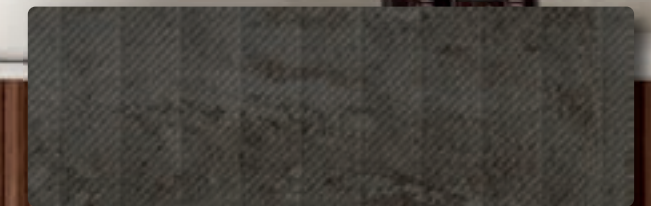

rlv hoyo acero



drava



Drava marfil / Rlv Don marfil / 30x90 / 12"x36"

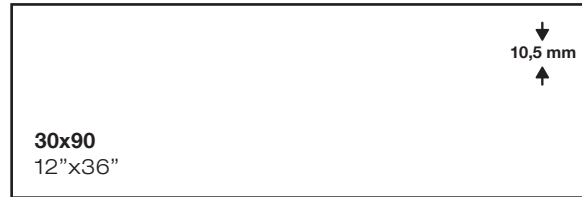

**PAVIMENTO COORDINADO**  
coordinated floor tile

**DRAVA / 60,8X60,8 cm**



**PACKING & SPECIAL PIECES**

	Pc/Cj	M2/Cj	Cj/PI	M2/PI	Kg/Cj	Kg/PI
30x90	4	1,08	64	69,12	18,75	1220
30x90 Rlv	5	1,35	63	85,05	20,22	1293,86

	Cód.	Cód.
Drava	MB140	MB145
	Rlv Don / Upa	
	Dc Mologa / Saale	MB146

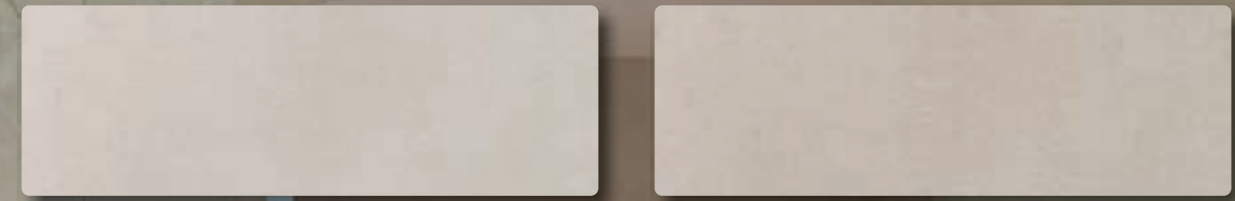

drava marfil

drava arena

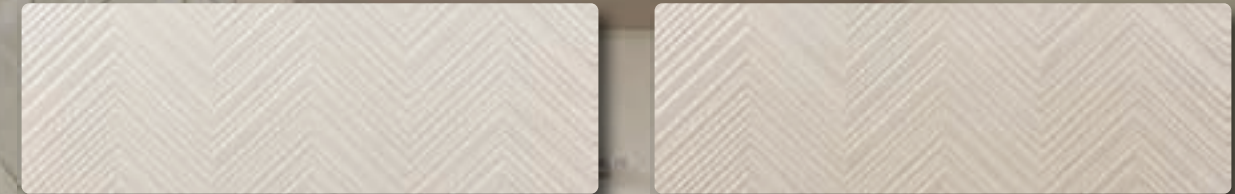

rlv upa marfil

rlv upa arena

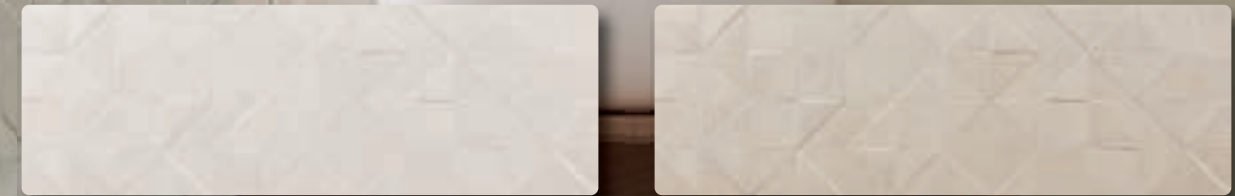

rlv don marfil

rlv don arena

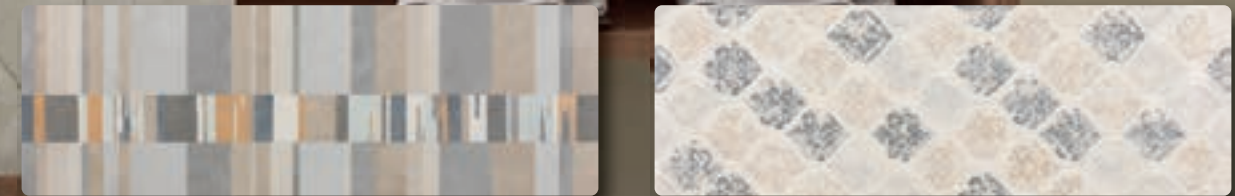

dc mologa mix

dc saale mix



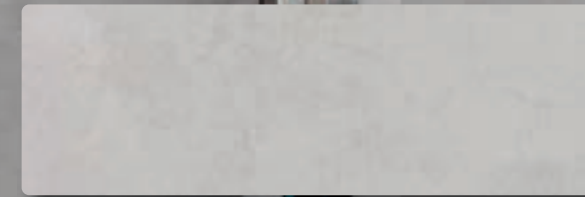

drava perla

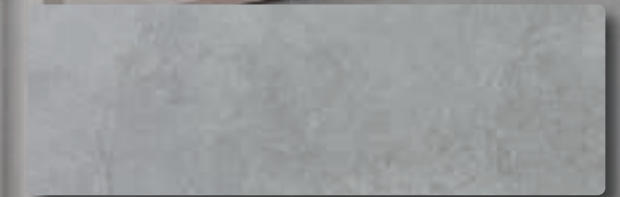

drava silver

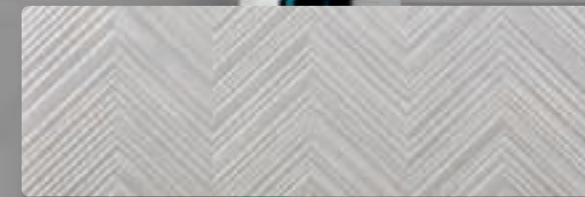

rlv upa perla



rlv upa silver

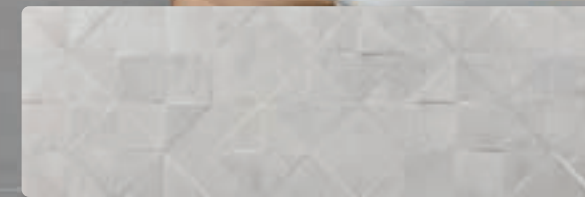

rlv don perla

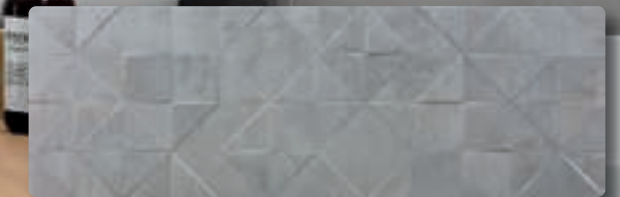

rlv don silver



dc mologa mix



dc saale mix



iris



WB



**PIEZAS ESPECIALES**  
special pieces

**MALLAS / 30X30 cm**



**PACKING & SPECIAL PIECES**

	Pc/Cj	M2/Cj	Cj/PI	M2/PI	Kg/Cj	Kg/PI
<b>30x90</b>	4	1,08	64	69,12	18,75	1220
<b>30x90 Rlv</b>	5	1,35	63	85,05	20,22	1293,86

	Cód.	Cód.
<b>Iris</b>	MB140	<b>Rlv Myra / Icon</b> MB145
<b>Malla</b>	P705	<b>Dc Iris / Canvas</b> MB146

Iris snow / Rlv Icon snow / Dc Iris 30x90 / 12''x36''

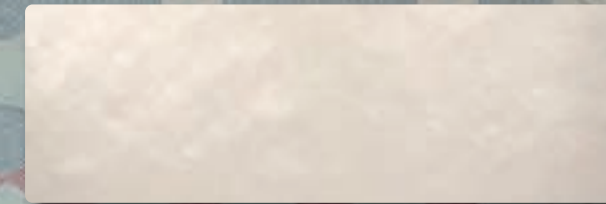

iris ivory

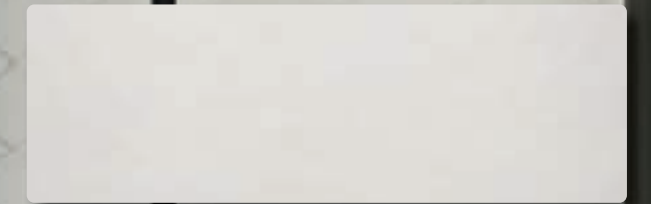

iris snow



iris acqua

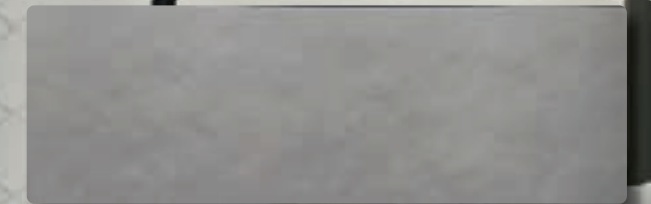

iris ash

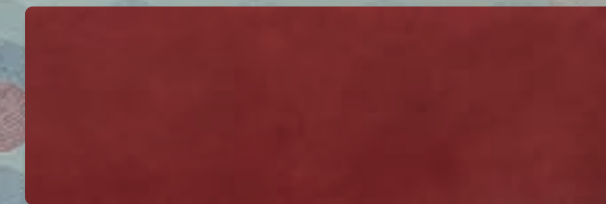

iris cherry

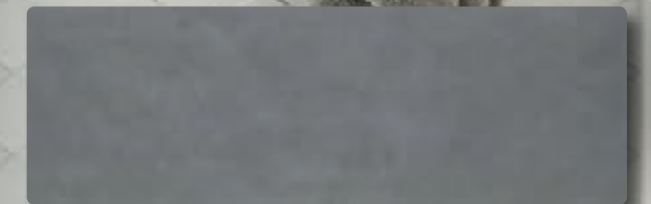

iris ocean



dc iris



\*dc canvas

\* Diferentes diseños en una caja / Mixed designs in each box





rlv myra ivory

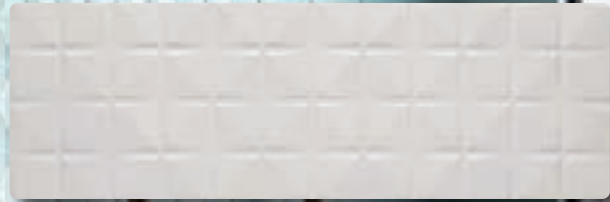

rlv myra snow



rlv myra acqua



rlv myra ash



rlv myra cherry



rlv myra ocean

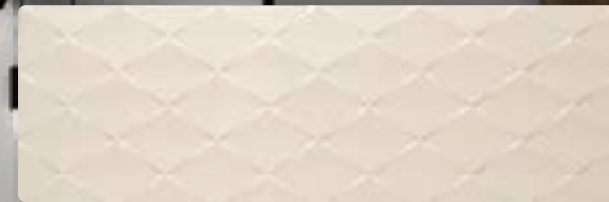

rlv icon ivory

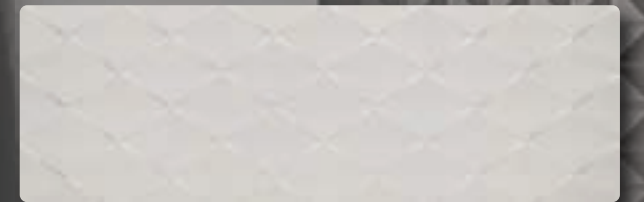

rlv icon snow

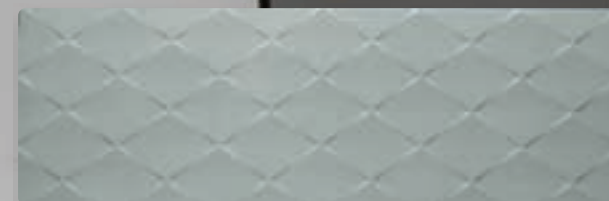

rlv icon acqua

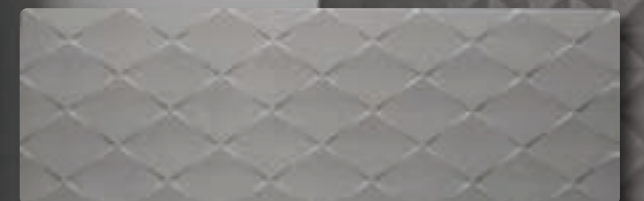

rlv icon ash



rlv icon cherry



rlv icon ocean



# litnos

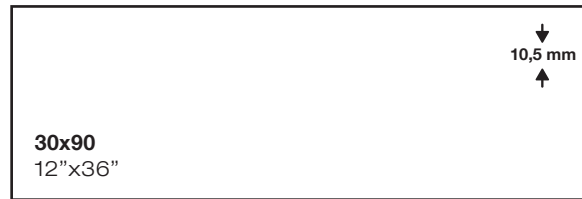

**PAVIMENTO RECOMENDADO**  
recommended floor tile

**FANLO** / 25X150 cm



**PACKING & SPECIAL PIECES**

	Pc/Cj	M2/Cj	Cj/PI	M2/PI	Kg/Cj	Kg/PI
<b>30x90</b>	4	1,08	64	69,12	18,75	1220
<b>30x90 Rlv</b>	5	1,35	63	85,05	20,22	1293,86

	Cód.	Cód.
<b>Lithos</b>	MB140	Rlv Tye MB145
	<b>Dc Lithos</b>	MB146

Lithos pearl / Dc Lithos 30x90 / 12"x36"

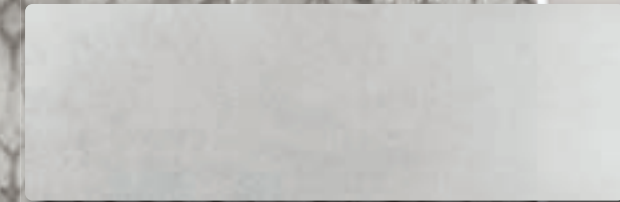

lithos pearl

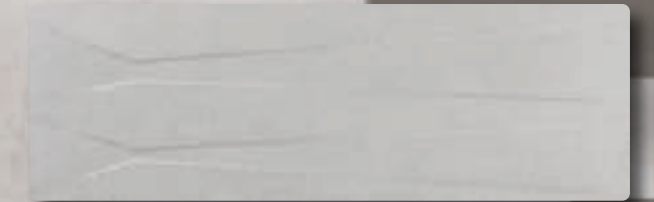

rlv tye pearl



lithos grey

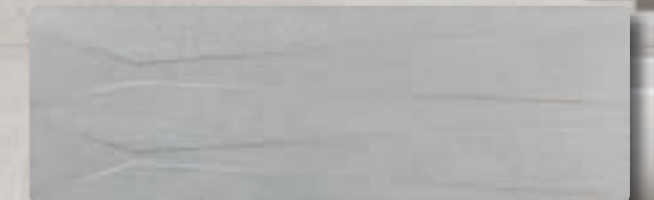

rlv tye grey



dc lithos



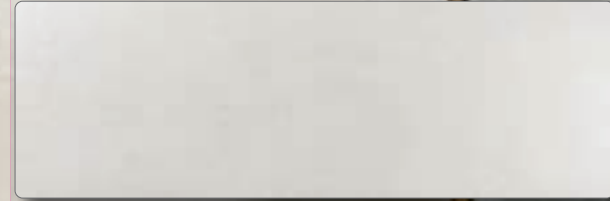

lithos white

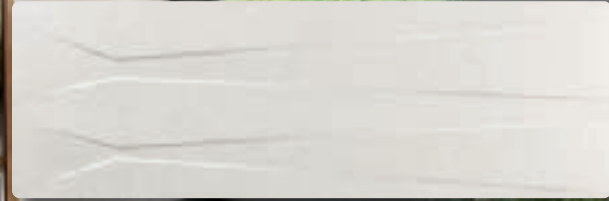

riv tye white

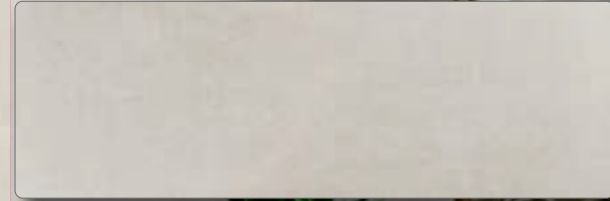

lithos beige



riv tye beige



dc lithos



# manhattan

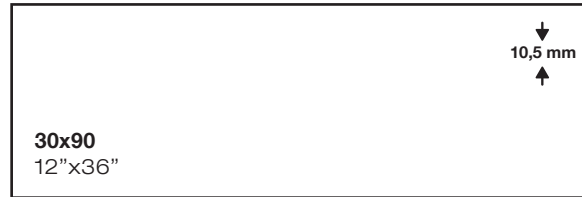

**PAVIMENTO COORDINADO**  
coordinated floor tile

**MANHATTAN 60X60 cm**

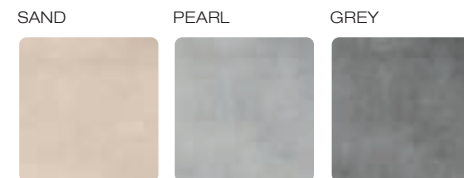

**PACKING & SPECIAL PIECES**

	Pc/Cj	M2/Cj	Cj/PI	M2/PI	Kg/Cj	Kg/PI
30x90	4	1,08	64	69,12	18,75	1220
30x90 Rlv	5	1,35	63	85,05	20,22	1293,86
	<b>Cód.</b>		<b>Cód.</b>			
<b>Manhattan</b>	MB140	<b>Rlv Manhattan</b>	MB145			



Manhattan pearl 30x90 / 12"x36" \_ Rlv Manhattan pearl 30x90 / 12"x36"

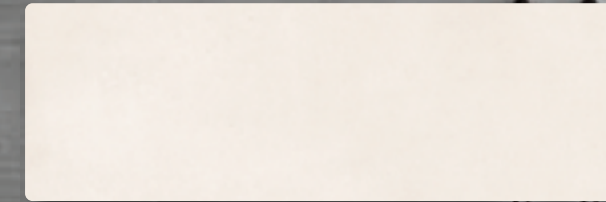

manhattan white

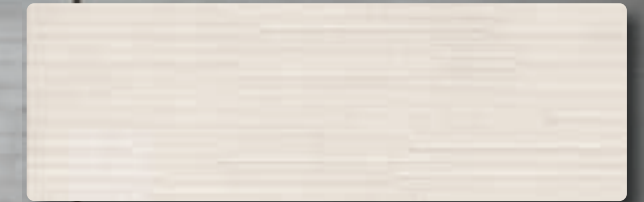

rlv manhattan white



manhattan sand

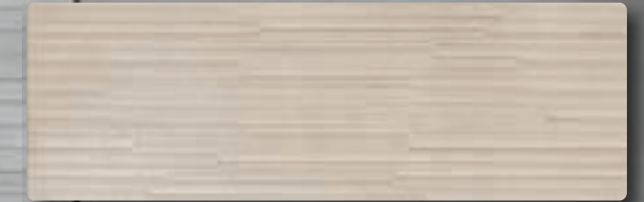

rlv manhattan sand

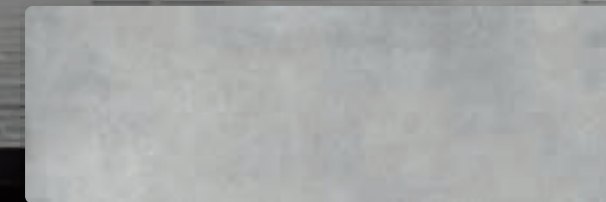

manhattan pearl



rlv manhattan pearl



manhattan grey



rlv manhattan grey



# merlino



Merlino perla / Rlv Merlino gris 30x90 / 12"x36"

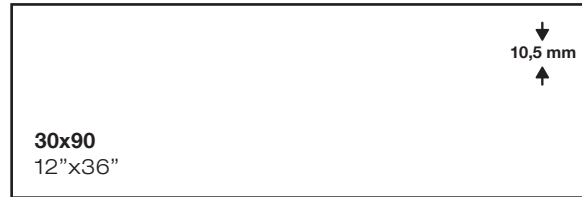

**PAVIMENTO RECOMENDADO**  
recommended floor tile

**FANLO** / 25X150 cm



**PACKING & SPECIAL PIECES**

	Pc/Cj	M2/Cj	Cj/PI	M2/PI	Kg/Cj	Kg/PI
<b>30x90</b>	4	1,08	64	69,12	18,75	1220
<b>30x90 Rlv</b>	5	1,35	63	85,05	20,22	1293,86

	Cód.		Cód.
<b>Merlino</b>	MB140	<b>Rlv Merlino</b>	MB145



merlino marfil

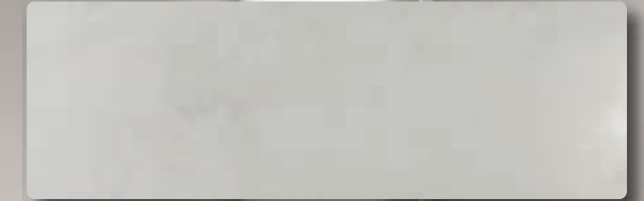

merlino perla



rlv merlino noce



rlv merlino gris



merlino gris



nature

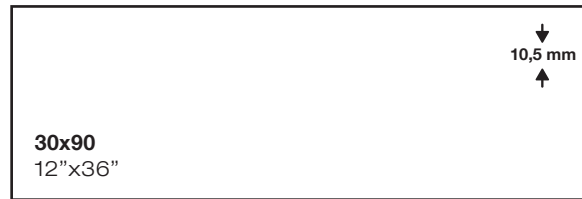

**PAVIMENTO COORDINADO**  
coordinated floor tile

**NATURE 60X60 cm**



**PACKING & SPECIAL PIECES**

	Pc/Cj	M2/Cj	Cj/PI	M2/PI	Kg/Cj	Kg/PI
<b>30x90</b>	4	1,08	64	69,12	18,75	1220
<b>30x90 Rlv</b>	5	1,35	63	85,05	20,22	1293,86

	Cód.	Cód.
<b>Nature</b>	MB140	<b>Rlv Nature</b> MB145

Nature gris / Rlv Nature gris 30x90 / 12"x36" \_ Nature gris 60x60 / 24"x24"

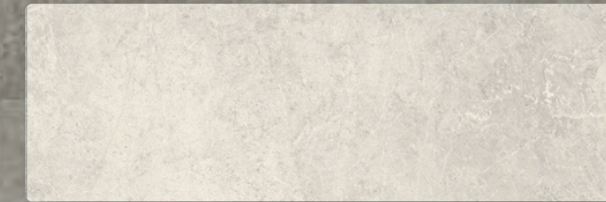

nature perla

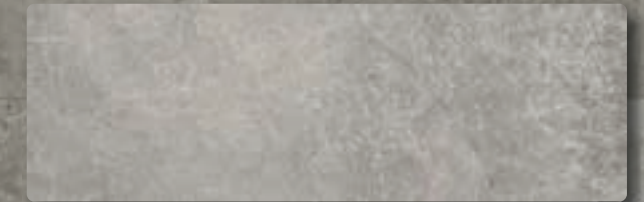

nature gris

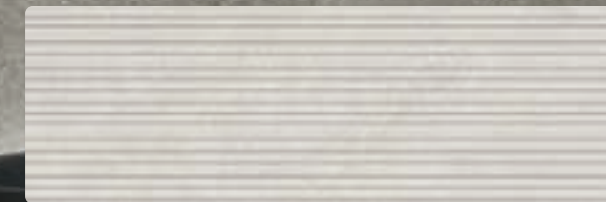

rlv nature perla

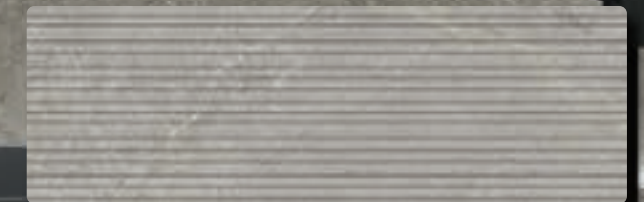

rlv nature gris



# rochee



Rochee / Rlv Rochee 30x90 / 12"x36" \_ Valdivia gris 60x60 / 24"x24"



 Serie también disponible en brillo pág. 326  
Series also available in gloss p. 326  
Série également disponible en brillant p. 326  
Serie auch in Glanz erhältlich p. 326

### PAVIMENTO RECOMENDADO

recommended floor tile

VALDIVIA / 60X60 cm



### PACKING & SPECIAL PIECES

	Pc/Cj	M2/Cj	Cj/PI	M2/PI	Kg/Cj	Kg/PI
30x90	4	1,08	64	69,12	18,75	1220
30x90 Rlv	5	1,35	63	85,05	20,22	1293,86

	Cód.	Cód.
Rochee	MB140	Rlv rochee MB145



rochee

rlv rochee



# royal



WB



30x90  
12"x36"

↓  
10,5 mm  
↑

### PAVIMENTO RECOMENDADO

recommended floor tile

☀️ ROYAL / 60,8X60,8 cm

MARFIL

PERLA

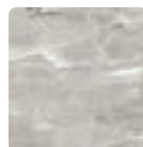
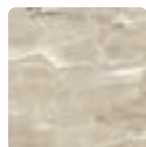

### PACKING & SPECIAL PIECES

	Pc/Cj	M2/Cj	Cj/PI	M2/PI	Kg/Cj	Kg/PI
30x90	4	1,08	64	69,12	18,75	1220
30x90 Rlv	5	1,35	63	85,05	20,22	1293,86

	Cód.		Cód.
Royal	MB140	Rlv Royal	MB145
		Rlv Georoyal	MB145

Royal marfil / Rlv Georoyal marfil 30x90 / 12"x36"



royal marfil



royal perla



rlv lineroyal marfil



rlv lineroyal perla



rlv georoyal marfil



rlv georoyal perla



# Serene



## PAVIMENTO COORDINADO

coordinated floor tile

### SERENE 60X60 cm

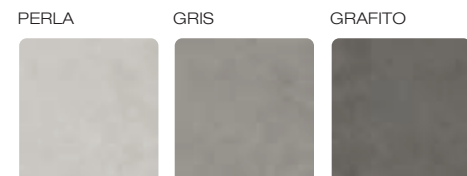

## PACKING & SPECIAL PIECES

	Pc/Cj	M2/Cj	Cj/PI	M2/PI	Kg/Cj	Kg/PI
30x90	4	1,08	64	69,12	18,75	1220
30x90 Rlv	5	1,35	63	85,05	20,22	1293,86

	Cód.	Cód.
Serene	MB140	Rlv Serene MB145

Serene blanco / Rlv Serene blanco 30x90 / 12"x36"



serene blanco

rlv serene blanco

serene perla

rlv serene perla

serene gris

rlv serene gris



# timisoara



**Serie también disponible en brillo p. 316**  
 Series also available in gloss p. 316  
 Série également disponible en brillant p. 316  
 Serie auch in Glanz erhältlich p. 316



**PAVIMENTO RECOMENDADO**  
 recommended floor tile

**METHOD** 60X60 cm

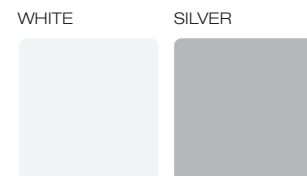

## PACKING & SPECIAL PIECES

	Pc/Cj	M2/Cj	Cj/PI	M2/PI	Kg/Cj	Kg/PI
<b>30x90</b>	4	1,08	64	69,12	18,75	1220
<b>30x90 Rlv</b>	5	1,35	63	85,05	20,22	1293,86

	Cód.	Cód.
<b>Timisoara</b>	MB140	<b>Rlv Galagos</b> MB145
		<b>Rlv Kross</b> MB145

Timisoara / Rlv Kross 30x90 / 12"x36"

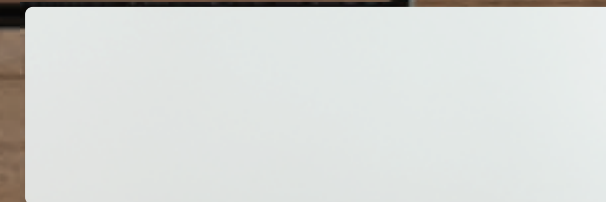

timisoara



rlv kross haya

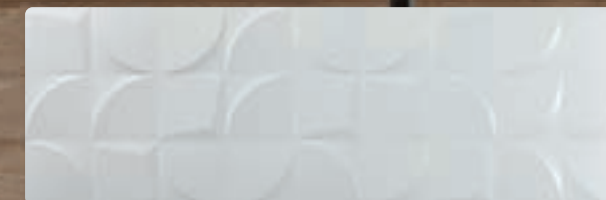

rlv galagos brillo



rlv kross

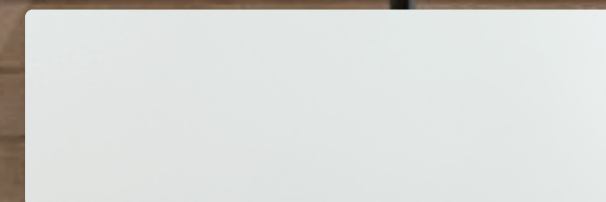

timisoara



rlv kross gris

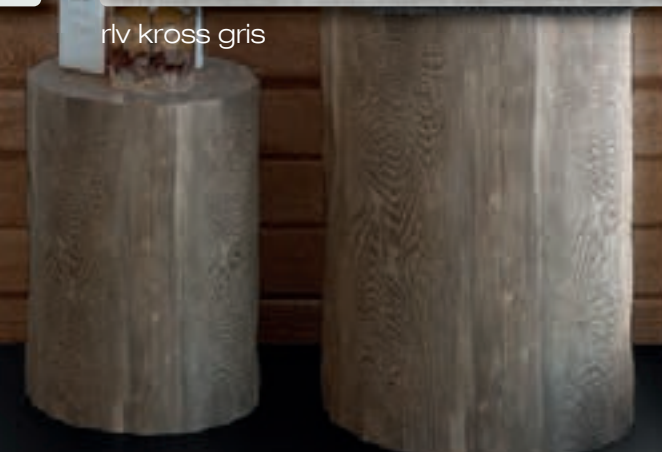



# daffen



Serie también disponible en brillo p. 358  
 Series also available in gloss p. 358  
 Série également disponible en brillant p. 358  
 Serie auch in Glanz erhältlich p. 358



## PAVIMENTO RECOMENDADO

recommended floor tile

FANLO / 25X150 cm



## PACKING & SPECIAL PIECES

	Pc/Cj	M2/Cj	Cj/Pl	M2/Pl	Kg/Cj	Kg/Pl
33,3x100	6	2	48	96	24	1172
33,3x100 Rlv	5	1,67	48	80,16	23	1124

	Cód.	Cód.
Daffen	MB150	MB155
Rlv Ted		
Rlv Hanne		MB155

Daffen blanco / Rlv Ted brillo 30x90 / 12"x36"

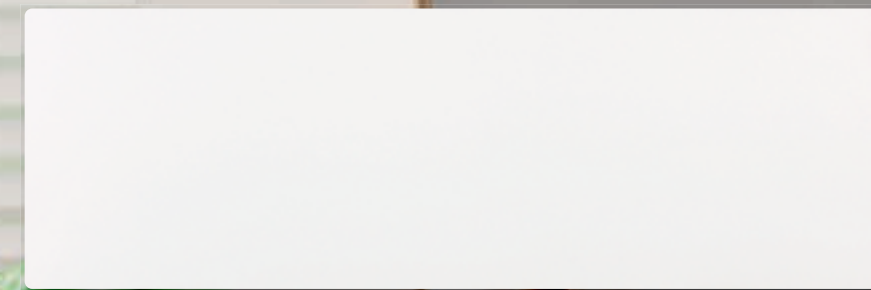

daffen blanco

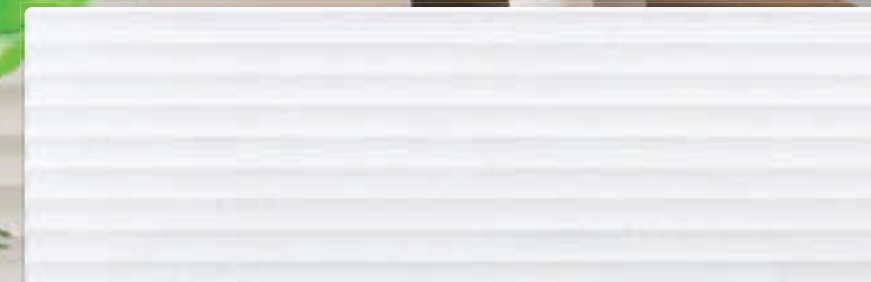

rlv ted brillo

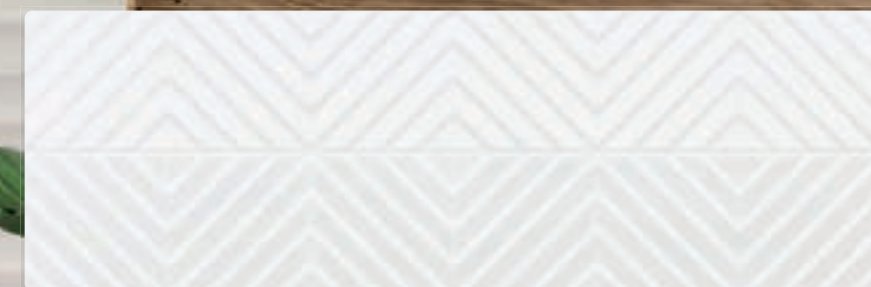

rlv hanne brillo



# ethan



Serie también disponible en brillo p. 356  
 Series also available in gloss p. 356  
 Série également disponible en brillant p. 356  
 Serie auch in Glanz erhältlich p. 356

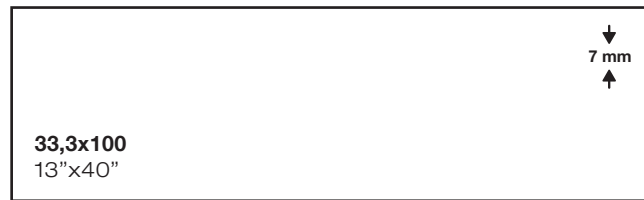

## PAVIMENTO RECOMENDADO

recommended floor tile

### FANLO / 25X150 cm



## PACKING & SPECIAL PIECES

	Pc/Cj	M2/Cj	Cj/PI	M2/PI	Kg/Cj	Kg/PI
33,3x100	6	2	48	96	24	1172
33,3x100 Rlv	5	1,67	48	80,16	23	1124

	Cód.	Cód.
Ethan	MB150	Rlv Ted MB155
		Rlv Hanne MB155

Ethan blanco / Rlv Hanne mate 30x90 / 12"x36"

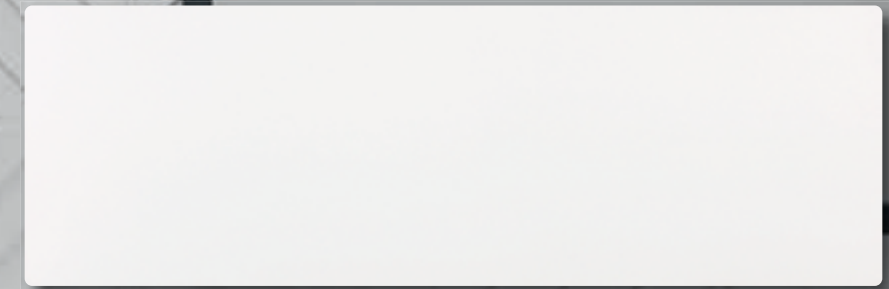

ethan blanco

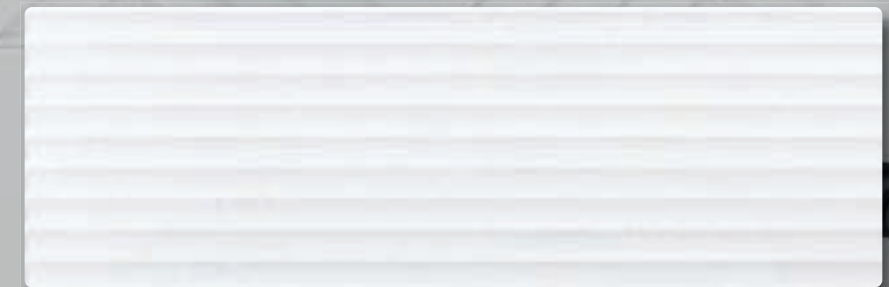

rlv ted mate

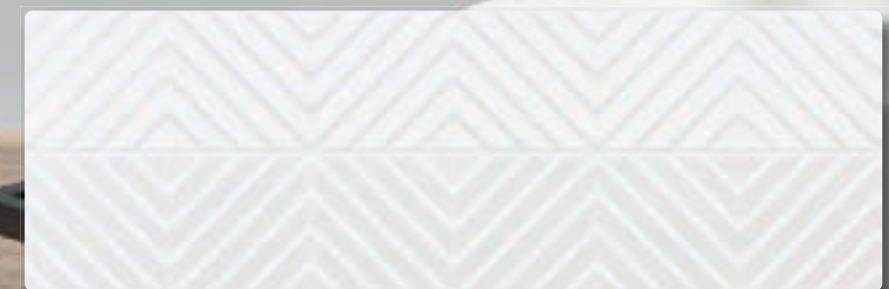

rlv hanne mate



# kamen



## PAVIMENTO COORDINADO

coordinated floor tile

**KAMEN** / 60,8X60,8 cm



## PACKING & SPECIAL PIECES

	Pc/Cj	M2/Cj	Cj/PI	M2/PI	Kg/Cj	Kg/PI
33,3x100	6	2	48	96	24	1172
33,3x100 Rlv	5	1,67	48	80,16	23	1124

	Cód.	Cód.
<b>Kamen</b>	MB150	<b>Rlv Bilice</b> MB155
	<b>Dc Lovret</b>	MB156

Kamen perla / Dc Lovret mix 33,3x100 / 13"x40"

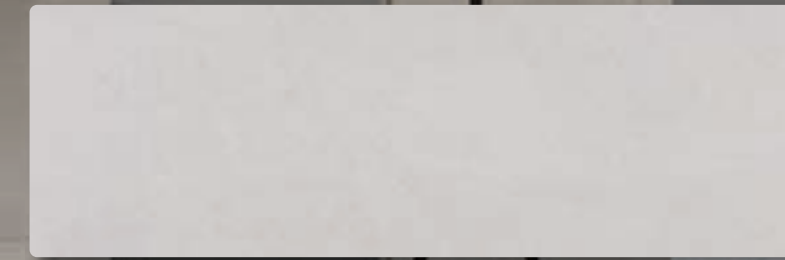

kamen perla

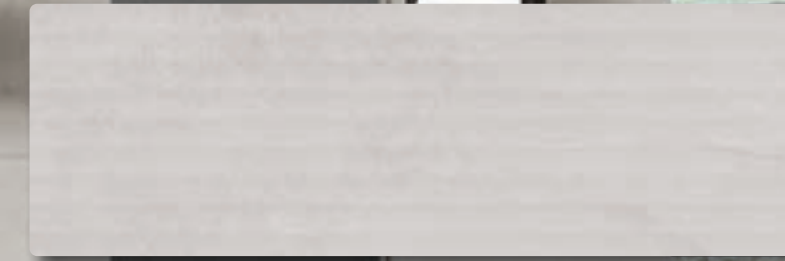

rlv bilice perla



rlv name perla



\*dc lovret mix

\* Diferentes diseños en una caja / Mixed designs in each box





kamen marfil



rlv bilice marfil



rlv name marfil



\*dc lovret mix

\* Diferentes diseños en una caja / Mixed designs in each box





small



sizes



## DE

Kleinformatige Fliesen,  
Produkte mit großer  
Vielseitigkeit und  
originellen Designs.

## FR

Carreaux de petits formats,  
des produits avec une  
grande polyvalence et des  
designs originaux.

## EN

Small sizes, creative  
designs, wide range of  
uses and assemblies.

## ES

Baldosas de pequeños  
formatos, productos  
con gran versatilidad  
y originales diseños.

black&white collection • pastel collection • mills



# black&white collection

PO    

↓  
11 mm  
↑  
**22,3x22,3**  
9"x9"



slava



hase

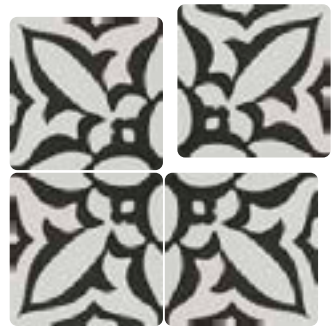

kira

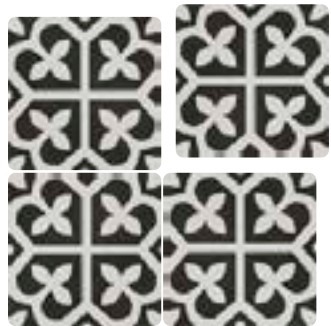

tycho



Tycho 22,3x22,3 / 9"x9"

## PACKING & SPECIAL PIECES

	Pc/Cj	M2/Cj	Cj/Pl	M2/Pl	Kg/Cj	Kg/Pl	Cód.
22,3x22,3	20	1	45	45	24	1100	MP101



# pastel collection

PO    

↓  
11 mm  
↑  
22,3x22,3  
9"x9"



bassel



mavis



amisi



volta



crile



laue



ricco



biela

## PACKING & SPECIAL PIECES

	Pc/Cj	M2/Cj	Cj/PI	M2/PI	Kg/Cj	Kg/PI	Cód.
22,3x22,3	20	1	45	45	24	1100	MP101

Volta 22,3x22,3 / 9"x9"





mills

PO    GRUPO  
Bla

↓  
11 mm  
↑  
22,3x22,3  
9"x9"

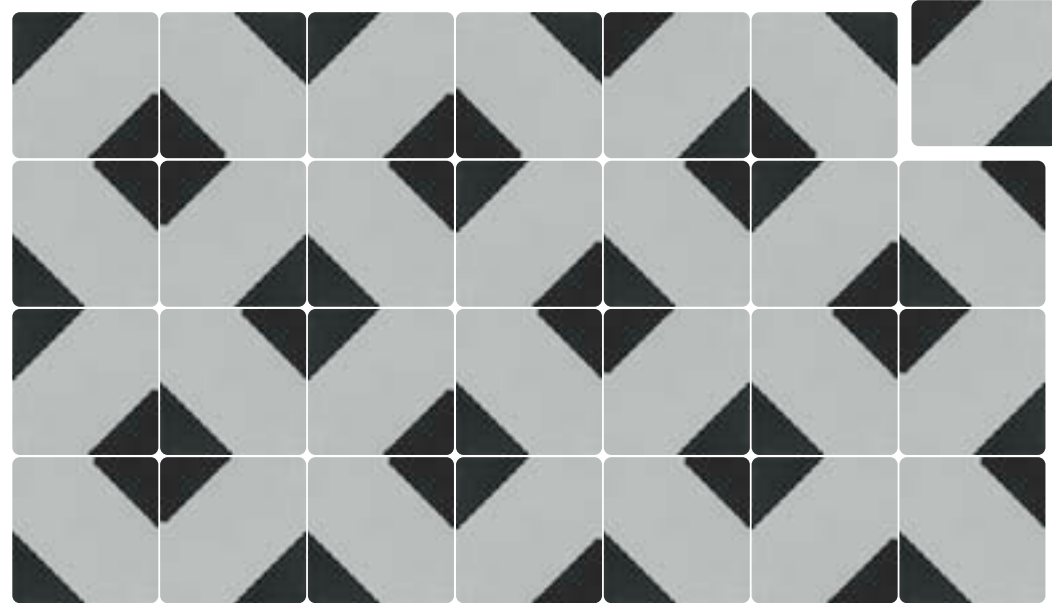

PACKING & SPECIAL PIECES

	Pc/Cj	M2/Cj	Cj/PI	M2/PI	Kg/Cj	Kg/PI	Cód.
22,3x22,3	20	1	45	45	24	1100	22,3x22,3 MP101

Mills 22,3x22,3 / 9"x9"

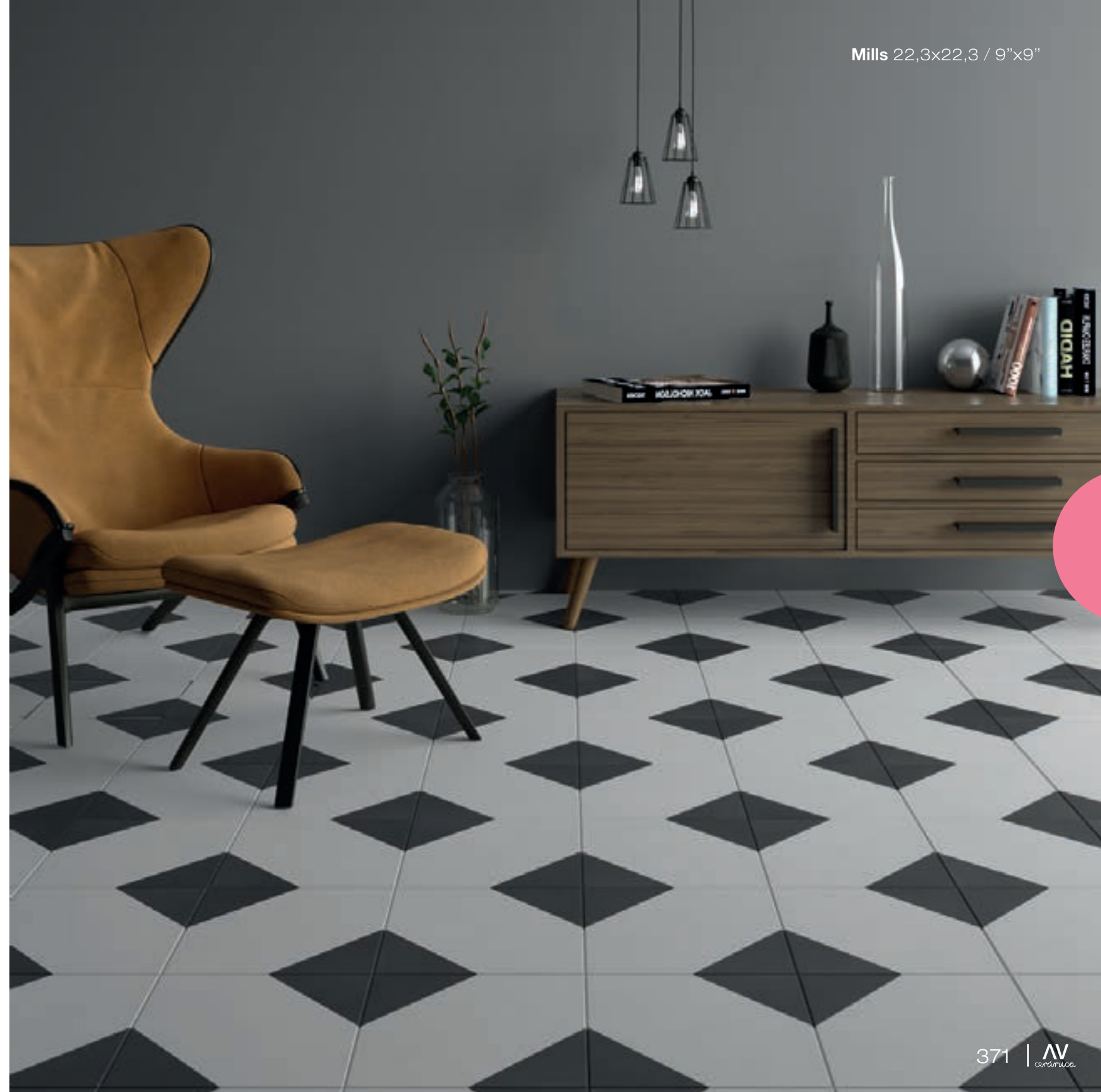





## DE

Eine Vielzahl von Oberflächen in allen Stilrichtungen.

safeer • matt collection • glossy collection • amyr • babylon • berlin • cheyenne drava • dylon • kamen • porto • royal • bellagio • bellagio gold • calica • dequa • gari

## FR

Plusieurs finitions dans tous les styles.

## EN

The most versatile formats and styles in glazed porcelain.

greece • massa • mutaz • racer • reno • rodano • sander • savanna • serene • styl taban • towns • ural • xiro • nature • status • rafaello • shea • belgravia • manhattan

## ES

Multitud de acabados en todos los estilos.



# safeer



17x52  
7"x21"  
8,8 mm



blanco



dark



arena

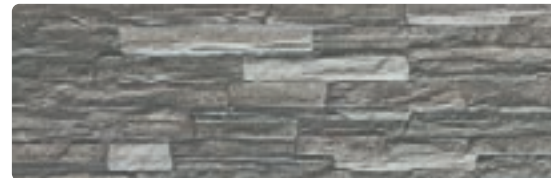

gris

## PACKING & SPECIAL PIECES

	Pc/Cj	M2/Cj	Cj/Pl	M2/Pl	Kg/Cj	Kg/Pl	Cód.
17x52	17	1,5	55	82,5	23,2	1296	17x52 MP100

Safeer blanco 17x52 / 7"x21"





# mat collection



Los modelos Ziro gris 60x60 y Southrock perla, gris y marengo 45x45 se pueden suministrar antideslizantes.  
 Ziro gris 60x60 and Southrock perla, gris and marengo 45x45 size can be supplied non-slip.  
 Ziro gris 60x60 et Southrock perla, gris and marengo 45x45 peut être fourni antidérapant.  
 Ziro gris 60x60 und Southrock perla, gris and marengo 45x45 kann rutschfest geliefert werden.

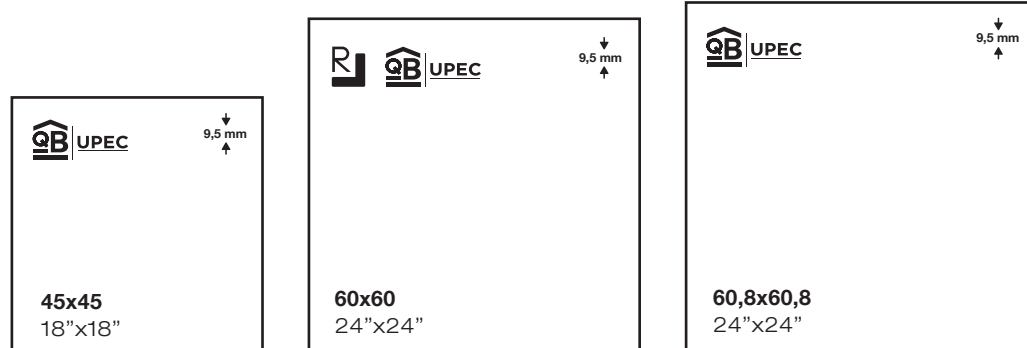

## PACKING & SPECIAL PIECES

	Pc/Cj	M2/Cj	Cj/PI	M2/PI	Kg/Cj	Kg/PI
45x45	6	1,22	52	63,44	25,8	1361,6
60x60	4	1,44	30	43,2	30	920
60,8x60,8	4	1,48	30	44,4	31,35	960,5

	Cód.	ADZ
Antibes 45x45	MP136	-
Antibes 60x60	MP175	-
Berlín 45x45	MP132	-
Berlín 60,8x60,8	MP160	-
Southrock	MP136	MP135
Ziro 45x45	MP136	-
Ziro 60x60	MP175	-

Ver página 581  
See page 581



Rodapié  
Skirting

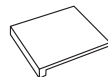

Peldaño  
Step

Ziro perla 60x60 / 24"x24"

ANTIBES 45X45 / 60X60 / R10



BERLÍN 45X45 / 60,8X60,8



SOUTHROCK 45X45



ZIRO 45X45 / 60X60 / R10





# glossy collection

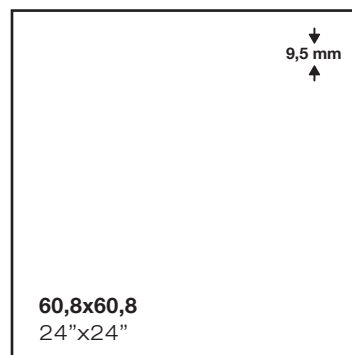

## PACKING & SPECIAL PIECES

	Pc/Cj	M2/Cj	Cj/PI	M2/PI	Kg/Cj	Kg/PI
<b>60,8x60,8</b>	4	1,48	30	44,4	31,35	960,5

	Cód.		Cód
<b>Nair</b>	MP161	<b>Daino</b>	MP161
<b>Calacatta</b>	MP161	<b>Graft</b>	MP161
<b>Luany</b>	MP161	<b>Reness</b>	MP161

**Ver página 581**  
See page 581



**Rodapié**  
Skirting



**Peldaño**  
Step

Luany perla 60,8x60,8 / 24"x24"

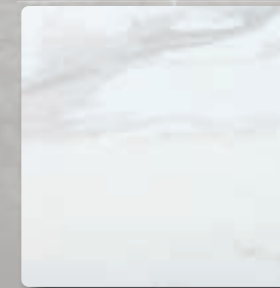

nair blanco

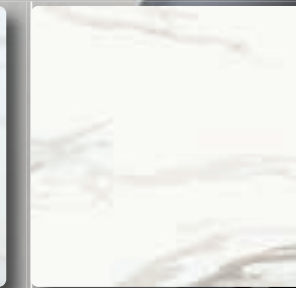

calacatta blanco



luany crema

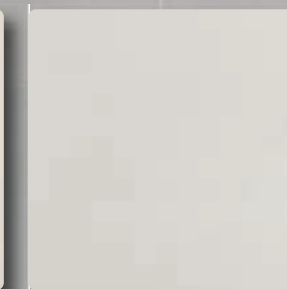

luany perla

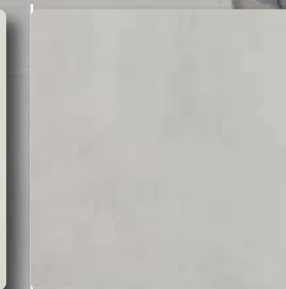

luany gris

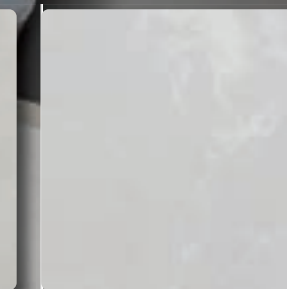

graft perla

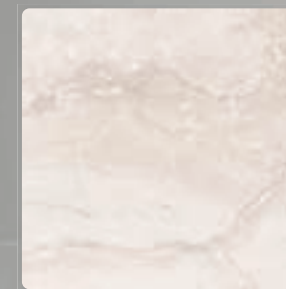

daino reale crema

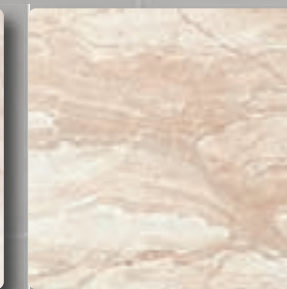

daino reale beige

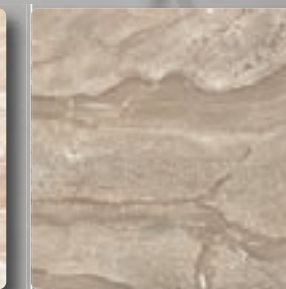

daino reale natural

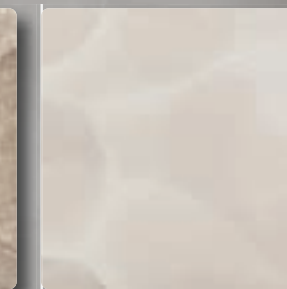

graft crema

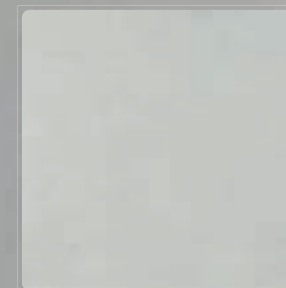

reness perla

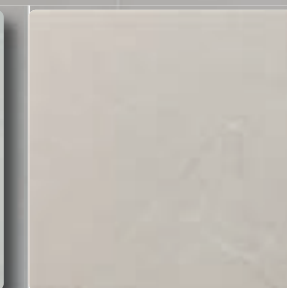

reness crema

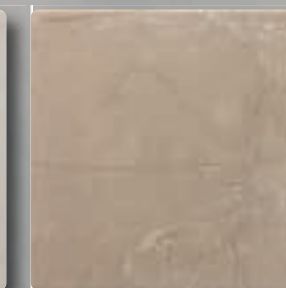

reness gold

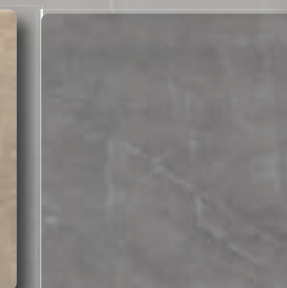

reness gris



amyr



PO



CMYK



V2

CLASE 3

GRUPO  
Bla

Interior y Exterior /  
Indoor and Outdoor /

in &  
out

Amyr musgo 60,8x60,8 / 24"x24"

↓  
9,5 mm  
↑  
**60,8x60,8**  
24"x24"

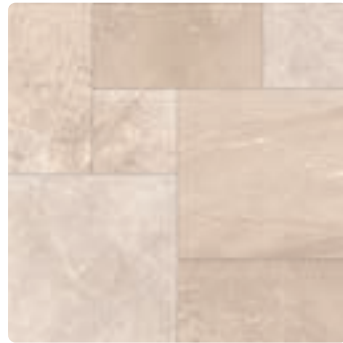

ivory



musgo



antracita

PACKING & SPECIAL PIECES

	Pc/Cj	M2/Cj	Cj/Pl	M2/Pl	Kg/Cj	Kg/Pl
<b>60,8x60,8</b>	4	1,48	30	44,4	31,35	960,5

	Cód.
<b>60,8x60,8</b>	MP165

☰ Ver página 581  
See page 581



Rodapié  
Skirting



Peldaño  
Step





# babylon



↓  
8,5 mm  
↑  
**60,8x60,8**  
24"x24"

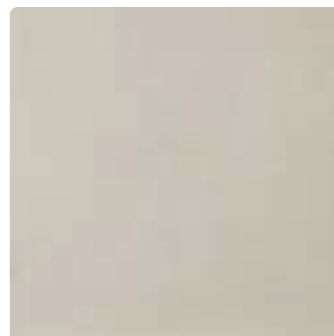

marfil



taupe

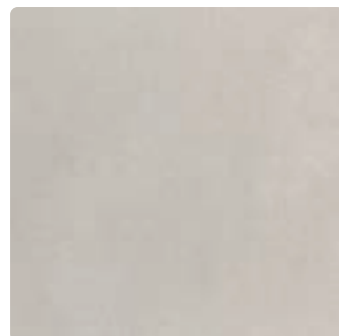

perla

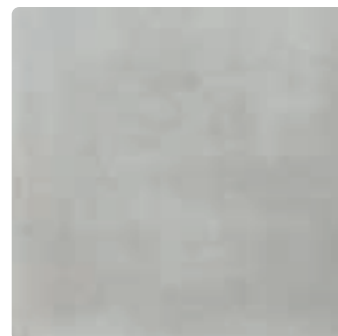

gris

## PACKING & SPECIAL PIECES

	Pc/Cj	M2/Cj	Cj/Pl	M2/Pl	Kg/Cj	Kg/Pl
<b>60,8x60,8</b>	5	1,85	30	55,5	34	1040

	Cód.
<b>60,8x60,8</b>	MP141

**Ver página 581**  
See page 581



**Rodapié**  
Skirting

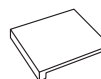

**Peldaño**  
Step



Babylon marfil 60,8x60,8 / 24"x24"





# berlín



 10,5 mm <b>75x75</b> 30"x30"	 9,5 mm <b>60,8x60,8</b> 24"x24"	 9,5 mm <b>45x45</b> 18"x18" perla - gris	9 mm <b>30,3x61,3</b> 12"x25"
--	---	---	-------------------------------------

 **Serie susceptible de tratamiento antideslizante bajo demanda.**  
Series susceptible to anti-slip treatment on request.  
Série sensible au traitement antidérapant sur demande.  
Serie mit Antirutschbehandlung auf Anfrage.



crema

perla

gris

grafito

## PACKING & SPECIAL PIECES

	Pc/Cj	M2/Cj	Cj/PI	M2/PI	Kg/Cj	Kg/PI
<b>30,3x61,3</b>	7	1,3	40	52	25	1020
<b>45x45</b>	6	1,22	52	63,44	25,8	1361,6
<b>60,8x60,8</b>	4	1,48	30	44,4	31,35	960,5
<b>75x75</b>	3	1,69	30	50,7	41,2	1256

	Cód.	Rect.
<b>30,3x61,3</b>	MP110	-
<b>45x45</b>	MP132	-
<b>60,8x60,8</b>	MP160	-
<b>75x75</b>	-	MP190

 **Ver página 581**  
See page 581



**Rodapié**  
Skirting

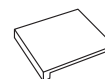

**Peldaño**  
Step

Berlín gris 45x45 / 18"x18"





# cheyenne



↓  
8,5 mm  
↑  
**60,8x60,8**  
24"x24"



crema



perla

## PACKING & SPECIAL PIECES

	Pc/Cj	M2/Cj	Cj/Pl	M2/Pl	Kg/Cj	Kg/Pl
<b>60,8x60,8</b>	5	1,85	30	55,5	34	1040

	Cód.
<b>60,8x60,8</b>	MP141

**Ver página 581**  
See page 581



**Rodapié**  
Skirting

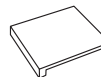

**Peldaño**  
Step

Cheyenne perla 60,8x60,8 / 24"x24"





# drava



Drava marfil 60,8x60,8 / 24"x24"

↓  
9,5 mm  
↑  
**60,8x60,8**  
24"x24"



**Serie susceptible de tratamiento antideslizante bajo demanda.**  
Series susceptible to anti-slip treatment on request.  
Série sensible au traitement antidérapant sur demande.  
Serie mit Antirutschbehandlung auf Anfrage.

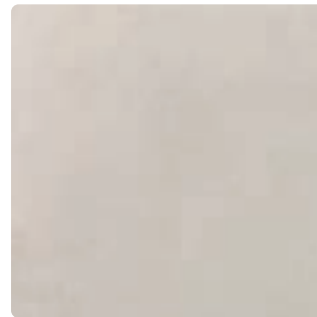

marfil

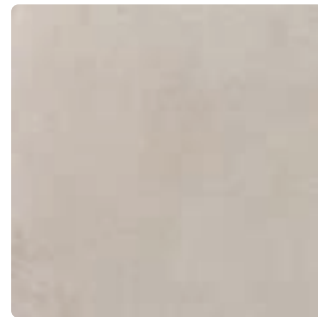

arena

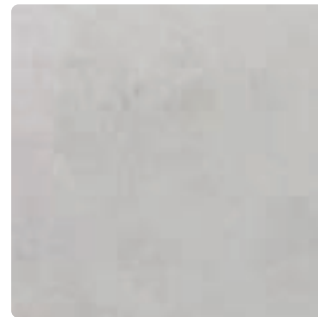

perla

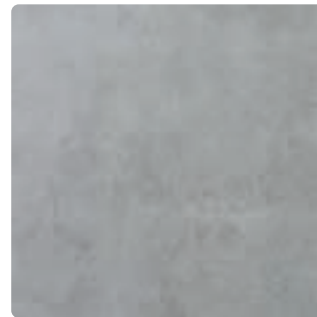

silver

## PACKING & SPECIAL PIECES

	Pc/Cj	M2/Cj	Cj/Pl	M2/Pl	Kg/Cj	Kg/Pl
<b>60,8x60,8</b>	4	1,48	30	44,4	31,35	960,5

	Cód.
<b>60,8x60,8</b>	MP160

**Ver página 581**  
See page 581



**Rodapié**  
Skirting

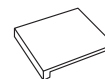

**Peldaño**  
Step





# dylon

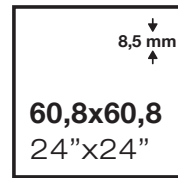
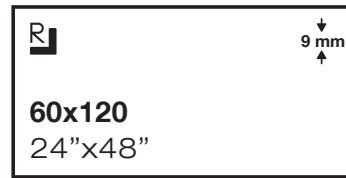
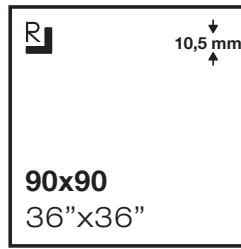

**Serie susceptible de tratamiento antideslizante bajo demanda.**  
Series susceptible to anti-slip treatment on request.  
Série sensible au traitement antidérapant sur demande.  
Serie mit Antirutschbehandlung auf Anfrage.

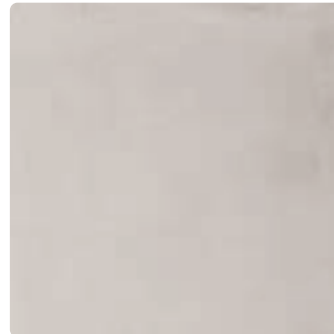

marfil

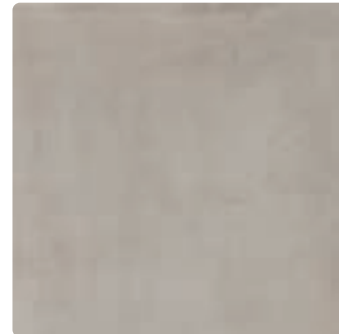

taupe

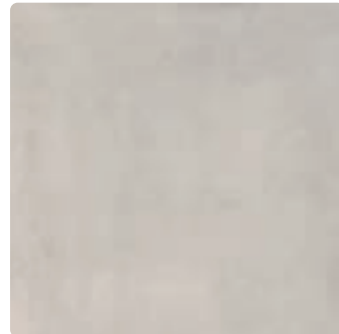

perla

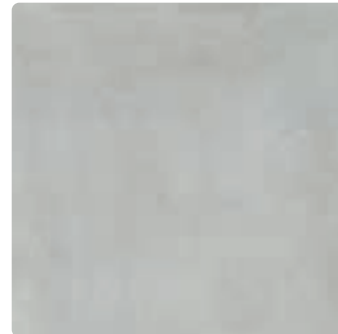

gris

## PACKING & SPECIAL PIECES

	Pc/Cj	M2/Cj	Cj/Pl	M2/Pl	Kg/Cj	Kg/Pl
<b>60,8x60,8</b>	5	1,85	30	55,5	34	1040
<b>90x90</b>	2	1,62	27	43,74	40	1100
<b>60x120</b>	2	1,44	36	51,84	29,5	1082

	Cód.	Rect.
<b>60,8x60,8</b>	MP140	-
<b>90x90</b>	-	MP201
<b>60x120</b>	-	MP180

 **Ver página 581**  
See page 581



**Rodapié**  
Skirting

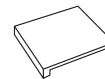

**Peldaño**  
Step

Dylon taupe 60x120 / 24"x48"





# kamen



↓  
9,5 mm  
↑  
**60,8x60,8**  
24"x24"

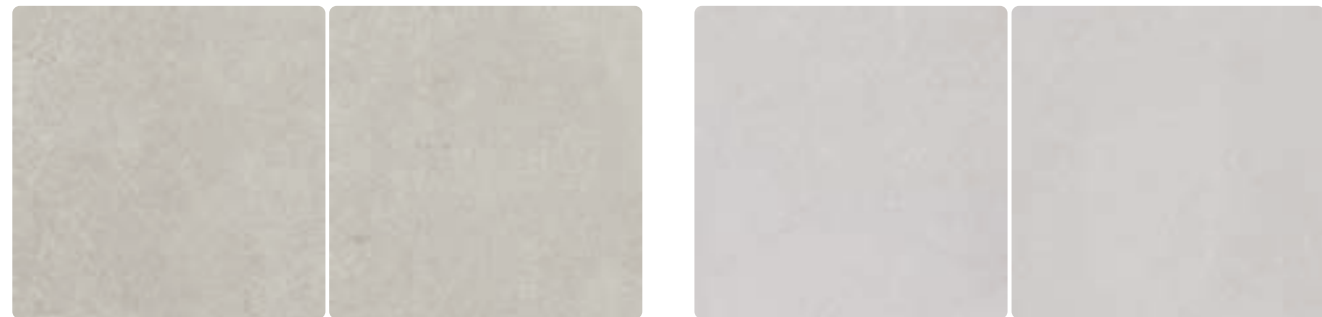

marfil

perla

## PACKING & SPECIAL PIECES

	Pc/Cj	M2/Cj	Cj/Pl	M2/Pl	Kg/Cj	Kg/Pl
<b>60,8x60,8</b>	4	1,48	30	44,4	31,35	960,5

	Cód.
<b>60,8x60,8</b>	MP160

**Ver página 581**  
See page 581



**Rodapié**  
Skirting



**Peldaño**  
Step

Kamen perla 60,8x60,8 / 24"x24"





porto



Interior y Exterior /  
Indoor and Outdoor /

**IN & OUT**

Porto gris 60,8x60,8 / 24"x24"

↓  
9,5 mm  
↑  
**60,8x60,8**  
24"x24"

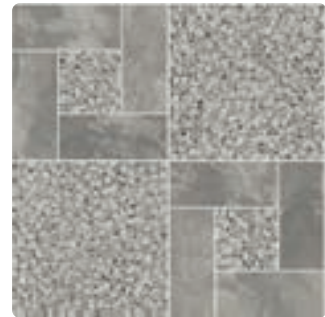

gris



magma



tierra

**PACKING & SPECIAL PIECES**

	Pc/Cj	M2/Cj	Cj/Pl	M2/Pl	Kg/Cj	Kg/Pl
<b>60,8x60,8</b>	4	1,48	30	44,4	31,35	960,5

	Cód.
<b>60,8x60,8</b>	MP165

 **Ver página 581**  
See page 581



**Rodapié**  
Skirting

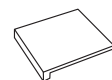

**Peldaño**  
Step





royal

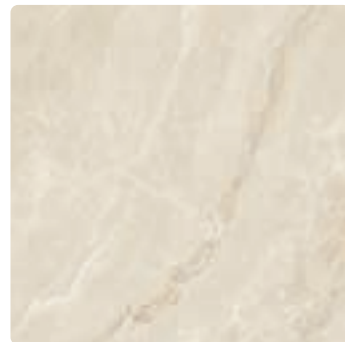
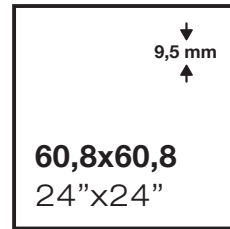

royal marfil

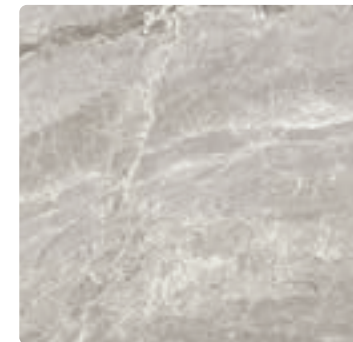

royal perla



PACKING & SPECIAL PIECES

	Pc/Cj	M2/Cj	Cj/Pl	M2/Pl	Kg/Cj	Kg/Pl	Cód.
60,8x60,8	4	1,48	30	44,4	31,35	960,5	60,8x60,8 MP161

Ver página 581  
See page 581



Rodapié  
Skirting

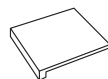

Peldaño  
Step

Royal marfil 60,8x60,8 / 24"x24"





# bellagio

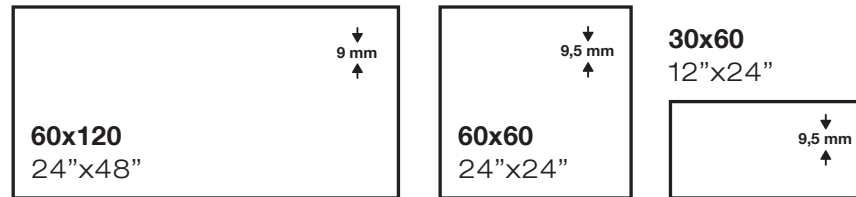

bellagio

## PACKING & SPECIAL PIECES

	Pc/Cj	M2/Cj	Cj/PI	M2/PI	Kg/Cj	Kg/PI
<b>30x60</b>	6	1,08	48	51,84	23,6	984
<b>60x60</b>	4	1,44	30	43,2	30	920
<b>60x120</b>	2	1,44	36	51,84	29,5	1082

	Cód.	Rect.
<b>30x60</b>	-	MP120
<b>60x60</b>	MP170	-
<b>60x120</b>	-	MP181

**Ver página 581**  
See page 581



**Rodapié**  
Skirting

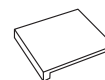

**Peldaño**  
Step

Bellagio 60x120 / 24"x48"





# bellagio gold



Bellagio gold 60,8x60,8 / 24"x24"

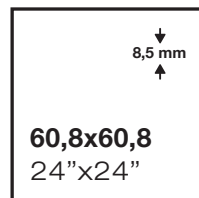
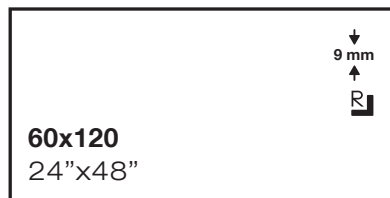

bellagio gold



## PACKING & SPECIAL PIECES

	Pc/Cj	M2/Cj	Cj/PI	M2/PI	Kg/Cj	Kg/PI
60,8x60,8	5	1,85	30	55,5	34	1040
60x120	2	1,44	36	51,84	29,5	1082

	Cód.	Rect.
60,8x60,8	MP141	-
60x120	-	MP181

Ver página 581  
See page 581



Rodapié  
Skirting

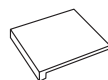

Peldaño  
Step



# calica



↓  
9,5 mm  
↑  
**60,8x60,8**  
24"x24"

↓  
9 mm  
↑  
**60x120**  
24"x48"

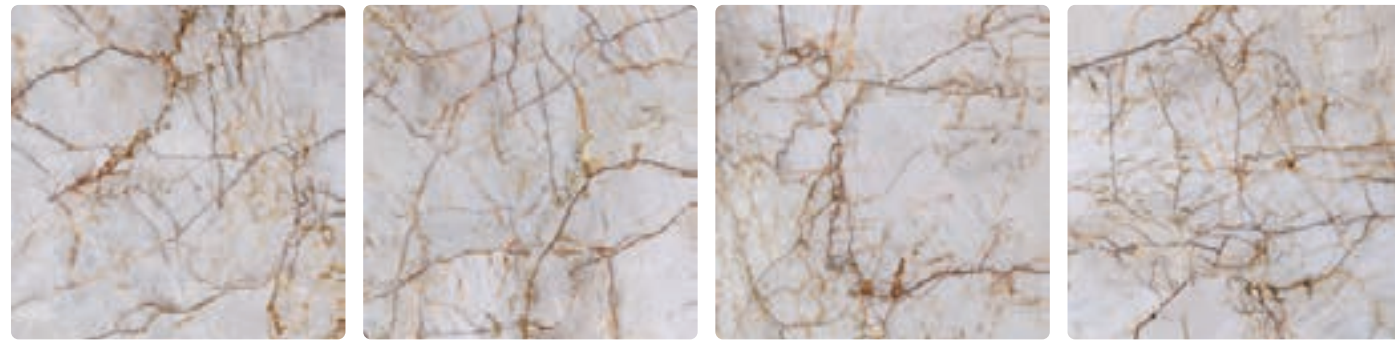

calica

## PACKING & SPECIAL PIECES

	Pc/Cj	M2/Cj	Cj/Pl	M2/Pl	Kg/Cj	Kg/Pl
<b>60,8x60,8</b>	4	1,48	30	44,4	31,35	960,5
<b>60x120</b>	2	1,44	36	51,84	29,5	1082

	Cód.	Rect.
<b>60,8x60,8</b>	MP161	-
<b>60x120</b>	-	MP181

**Ver página 581**  
See page 581



**Rodapié**  
Skirting

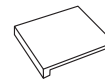

**Peldaño**  
Step

Calica 60x120 / 24"x48"





# dequa

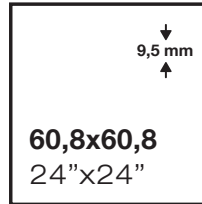

dequa marfil



dequa perla

## PACKING & SPECIAL PIECES

	Pc/Cj	M2/Cj	Cj/Pl	M2/Pl	Kg/Cj	Kg/Pl
60,8x60,8	4	1,48	30	44,4	31,35	960,5
60x120	2	1,44	36	51,84	29,5	1082

	Cód.	Rect.
60,8x60,8	MP161	-
60x120	-	MP181

Ver página 581  
See page 581



Rodapié  
Skirting

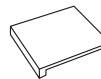

Peldaño  
Step

Dequa marfil 60x120 / 24"x48"





gari



PO



↓  
9,5 mm  
↑  
**60,8x60,8**  
24"x24"

↓  
9 mm  
↑  
**60x120**  
24"x48"



gari blanco

**PACKING & SPECIAL PIECES**

	Pc/Cj	M2/Cj	Cj/Pl	M2/Pl	Kg/Cj	Kg/Pl
<b>60,8x60,8</b>	4	1,48	30	44,4	31,35	960,5
<b>60x120</b>	2	1,44	36	51,84	29,5	1082

	Cód.	Rect.
<b>60,8x60,8</b>	MP161	-
<b>60x120</b>	-	MP181

**Ver página 581**  
See page 581



**Rodapié**  
Skirting

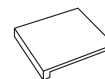

**Peldaño**  
Step

Gari blanco 60x120 / 24"x48"





# greece



Greece blanco 60,8x60,8 / 24"x24"

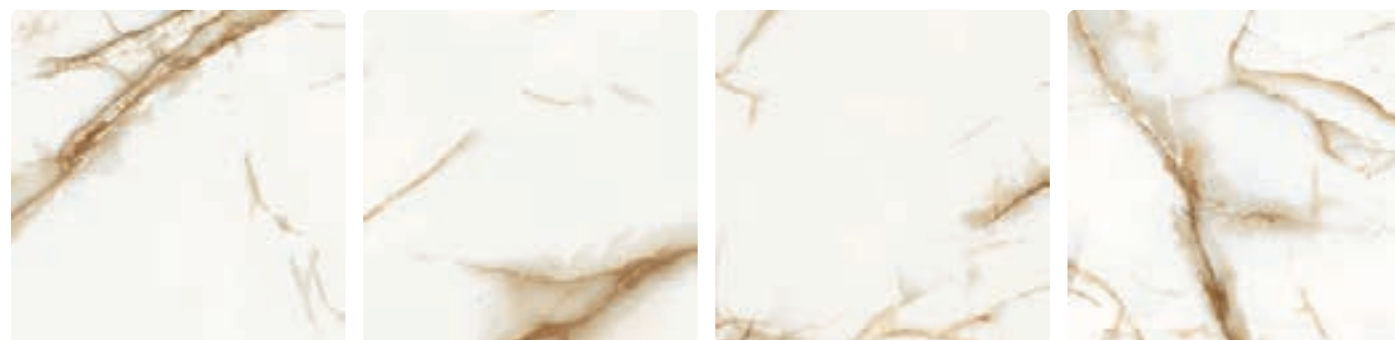
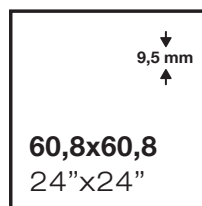

greece blanco



## PACKING & SPECIAL PIECES

	Pc/Cj	M2/Cj	Cj/Pl	M2/Pl	Kg/Cj	Kg/Pl
60,8x60,8	4	1,48	30	44,4	31,35	960,5
60x120	2	1,44	36	51,84	29,5	1082

	Cód.	Rect.
60,8x60,8	MP161	-
60x120	-	MP181

Ver página 581  
See page 581



Rodapié  
Skirting



Peldaño  
Step



# massa



Massa white 60x120 / 24"x48"

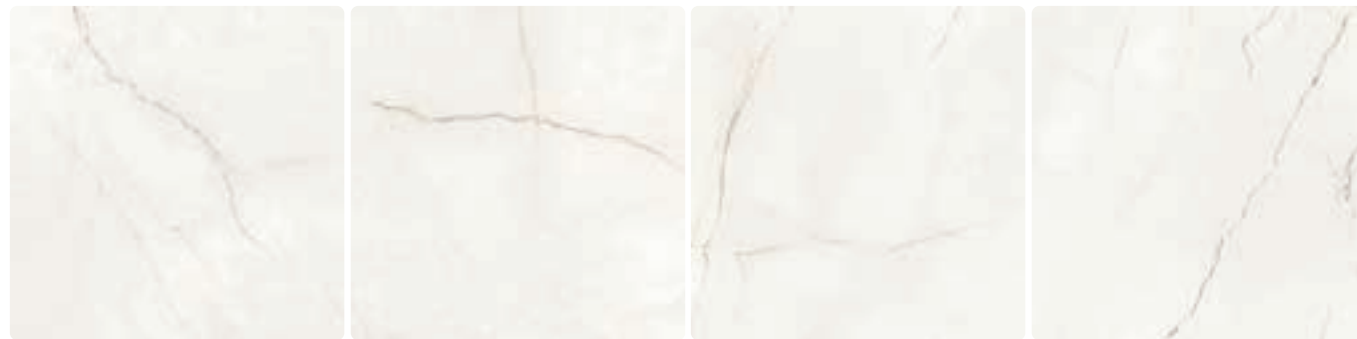
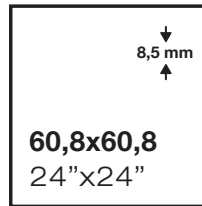

white

## PACKING & SPECIAL PIECES

	Pc/Cj	M2/Cj	Cj/PI	M2/PI	Kg/Cj	Kg/PI
<b>60,8x60,8</b>	5	1,85	30	55,5	34	1040
<b>60x120</b>	2	1,44	36	51,84	29,5	1082

	Cód.	Rect.
<b>60,8x60,8</b>	MP141	-
<b>60x120</b>	-	MP181

**Ver página 581**  
See page 581



**Rodapié**  
Skirting

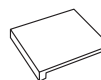

**Peldaño**  
Step





# mutaz

Interior y Exterior /  
Indoor and Outdoor /

## IN & OUT

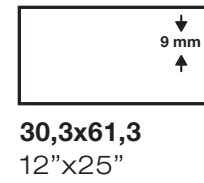
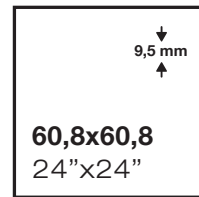

Mosaicos  
Mosaics  
Mosaïques  
Mosaik



mutaz blanco



mutaz crema



mutaz gris



mutaz marengo



Mutaz marengo 60,8x60,8 / 24"x24"

### PACKING & SPECIAL PIECES

	Pc/Cj	M2/Cj	Cj/Pl	M2/Pl	Kg/Cj	Kg/Pl
30,3x61,3	7	1,3	40	52	25	1020
60,8x60,8	4	1,48	30	44,4	31,35	960,5

	Cód.
30,3x61,3	MP116
60,8x60,8	MP165

Ver página 581  
See page 581

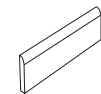

Rodapié  
Skirting

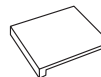

Peldaño  
Step

blanco

crema

gris

marengo



racer



↓  
8,5 mm  
↑  
**60,8x60,8**  
24"x24"

R ↓  
9 mm ↑  
**60x120**  
24"x48"

■ Serie también disponible en mate pág. 416  
Series also available in matt p. 416  
Série également disponible en mat p. 416  
Serie auch in matt erhältlich p. 416

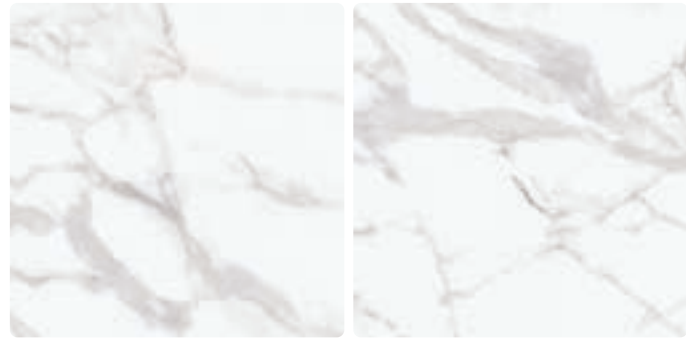

racer blanco

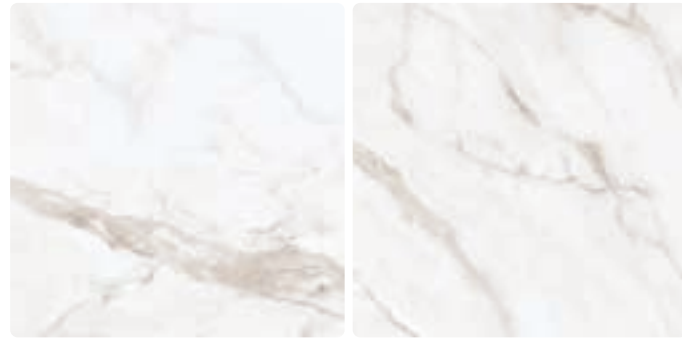

racer crema



Racer blanco 60x120 / 24"x48"

PACKING & SPECIAL PIECES

	Pc/Cj	M2/Cj	Cj/Pl	M2/Pl	Kg/Cj	Kg/Pl
<b>60,8x60,8</b>	5	1,85	30	55,5	34	1040
<b>60x120</b>	2	1,44	36	51,84	29,5	1082

	Cód.	Rect.
<b>60,8x60,8</b>	MP141	-
<b>60x120</b>	-	MP180

☰ Ver página 581  
See page 581



Rodapié  
Skirting

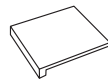

Peldaño  
Step



# reno



Reno blanco 60,8x60,8 / 24"x24"

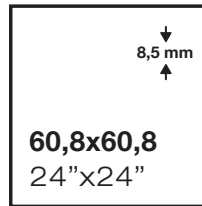

☀ **Serie también disponible en brillo pág. 414**  
 Series also available in gloss p. 414  
 Série également disponible en brillant p. 414  
 Serie auch in glänzend erhältlich p. 414

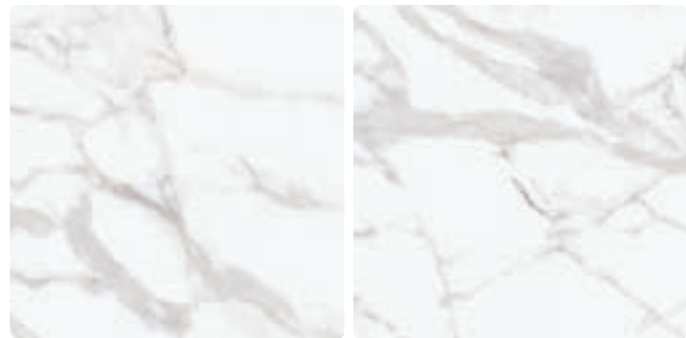

reno blanco

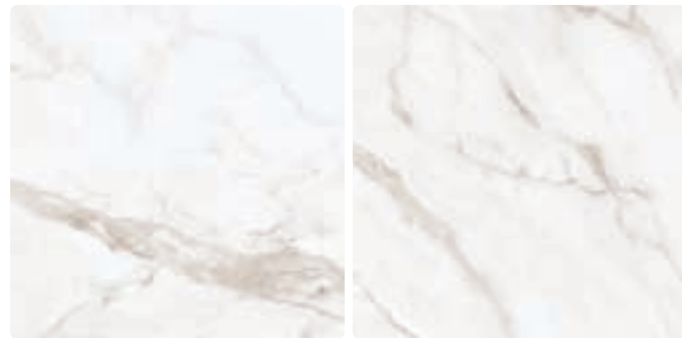

reno crema



## PACKING & SPECIAL PIECES

	Pc/Cj	M2/Cj	Cj/Pl	M2/Pl	Kg/Cj	Kg/Pl
60,8x60,8	5	1,85	30	55,5	34	1040
60x120	2	1,44	36	51,84	29,5	1082

	Cód.	Rect.
60,8x60,8	MP140	-
60x120	-	MP180

☰ **Ver página 581**  
See page 581



**Rodapié**  
Skirting



**Peldaño**  
Step



# rodano



↓  
9,5 mm  
↑  
**60,8x60,8**  
24"x24"



**Serie susceptible de tratamiento antideslizante bajo demanda.**  
Series susceptible to anti-slip treatment on request.  
Série sensible au traitement antidérapant sur demande.  
Serie mit Antirutschbehandlung auf Anfrage.

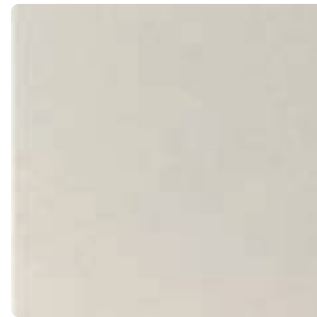

rodano marfil

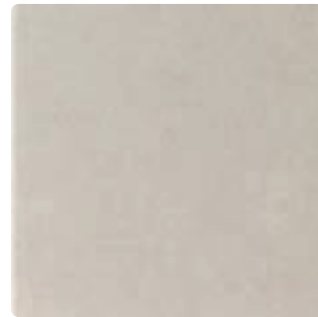

rodano natural



rodano perla



rodano gris

## PACKING & SPECIAL PIECES

	Pc/Cj	M2/Cj	Cj/Pl	M2/Pl	Kg/Cj	Kg/Pl
<b>60,8x60,8</b>	4	1,48	30	44,4	31,35	960,5

	Cód.
<b>60,8x60,8</b>	MP160

**Ver página 581**  
See page 581



**Rodapié**  
Skirting

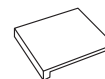

**Peldaño**  
Step

Rodano natural 60,8x60,8 / 24"x24"





# sander

Interior y Exterior /  
Indoor and Outdoor /

**in&out**

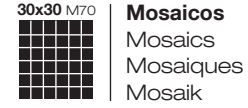
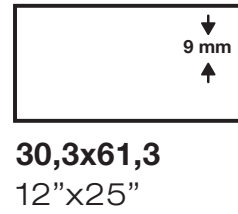
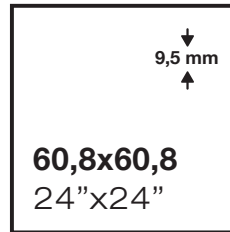

**30,3x61,3** 12"x25"



rly must blanco



rly must marfil



rly must perla



rly must silver

**30,3x61,3** 12"x25" / **60,8x60,8** 24"x24"



sander blanco

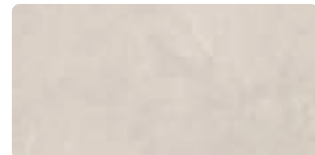

sander marfil

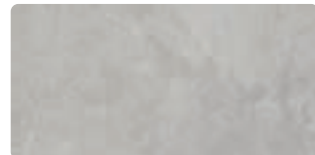

sander perla



sander silver

## PACKING & SPECIAL PIECES

	Pc/Cj	M2/Cj	Cj/Pl	M2/Pl	Kg/Cj	Kg/Pl
<b>30,3x61,3</b>	7	1,3	40	52	25	1020
<b>60,8x60,8</b>	4	1,48	30	44,4	31,35	960,5

	Cód.
<b>30,3x61,3</b>	MP116
<b>60,8x60,8</b>	MP165
<b>Rly Must</b>	MP115

**Ver página 581**  
See page 581



**Rodapié**  
Skirting

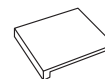

**Peldaño**  
Step

Sander silver / Rly must silver 30,3x61,3 / 12"x25" \_ Sander silver 60,8x60,8 / 24"x24"



blanco

marfil

perla

silver



# Savanna

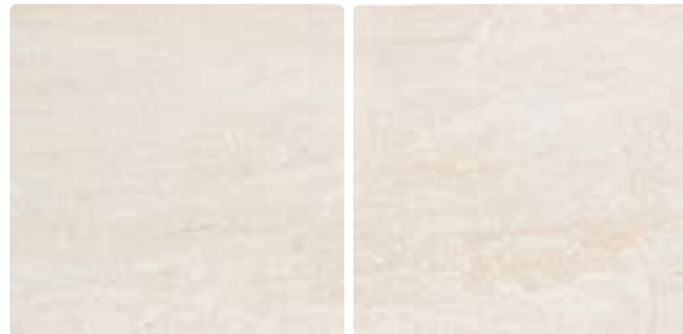
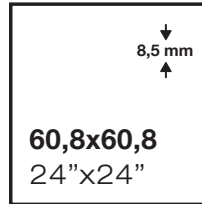

savanna crema

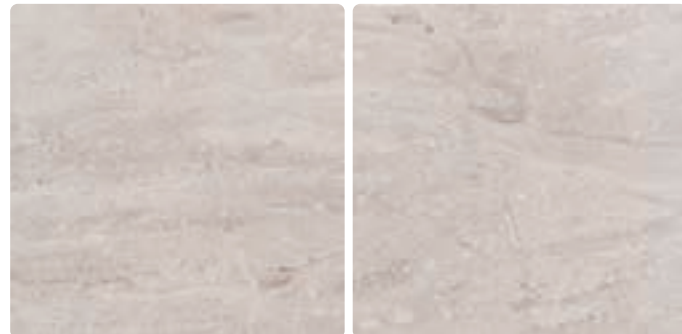

savanna gris

## PACKING & SPECIAL PIECES

	Pc/Cj	M2/Cj	Cj/Pl	M2/Pl	Kg/Cj	Kg/Pl
60,8x60,8	5	1,85	30	55,5	34	1040
60x120	2	1,44	36	51,84	29,5	1082

	Cód.	Rect.
60,8x60,8	MP141	-
60x120	-	MP181

Ver página 581  
See page 581



Rodapié  
Skirting



Peldaño  
Step

Savanna crema 60x120 / 24"x48"





# Serene



Serie susceptible de tratamiento antideslizante bajo demanda.  
 Series susceptible to anti-slip treatment on request.  
 Série sensible au traitement antidérapant sur demande.  
 Serie mit Antirutschbehandlung auf Anfrage.

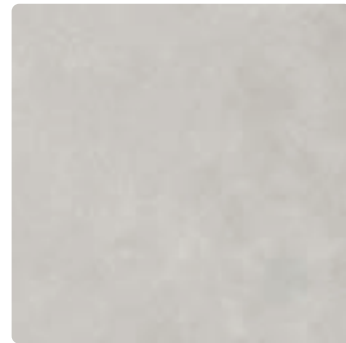

serene perla

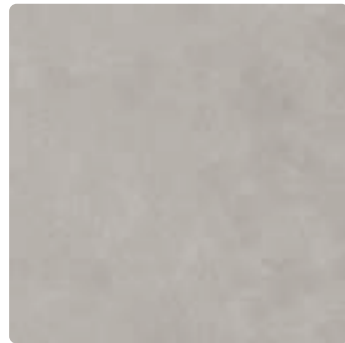

serene gris

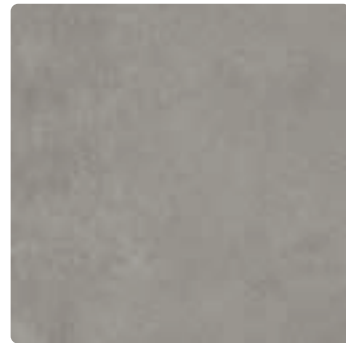

serene grafito

## PACKING & SPECIAL PIECES

	Pc/Cj	M2/Cj	Cj/PI	M2/PI	Kg/Cj	Kg/PI	
<b>30x60</b>	6	1,08	48	51,84	23,6	984	<b>Rect.</b>
<b>60x60</b>	4	1,44	30	43,2	30	920	<b>30x60</b> MP120
<b>60x120</b>	2	1,44	36	51,84	29,5	1082	<b>60x60</b> MP170
							<b>60x120</b> MP180

Ver página 581  
See page 581



**Rodapié**  
Skirting



**Peldaño**  
Step

Serene grafito 60x60 / 24"x24"





# styl

PO



CLASE 3

GRUPO Bla

Interior y Exterior /  
Indoor and Outdoor /

**in & out**

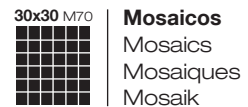
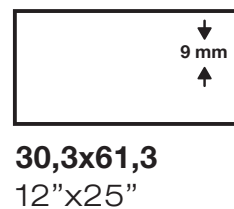
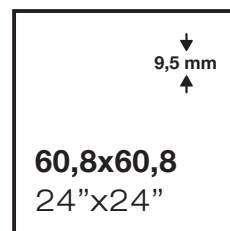

30,3x61,3 12"x25"



rlv elyt blanco



rlv elyt arena



rlv elyt perla



rlv elyt silver

30,3x61,3 12"x25" / 60,8x60,8 24"x24"



styl blanco

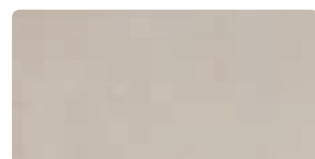

styl arena



styl perla

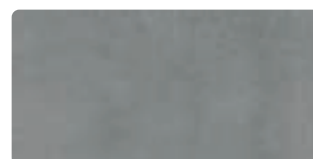

styl silver

## PACKING & SPECIAL PIECES

	Pc/Cj	M2/Cj	Cj/Pl	M2/Pl	Kg/Cj	Kg/Pl
30,3x61,3	7	1,3	40	52	25	1020
60,8x60,8	4	1,48	30	44,4	31,35	960,5

	Cód.
30,3x61,3	MP116
60,8x60,8	MP165
Rlv Elyt	MP115

Ver página 581  
See page 581



Rodapié  
Skirting

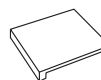

Peldaño  
Step

Styl arena \_ Rlv elyt arena 30,3x61,3 / 12"x25" \_ Styl arena 60,8x60,8 / 24"x24"



styl blanco

styl arena

styl perla

styl silver



# taban



Taban 60,8x60,8 / 24"x24"

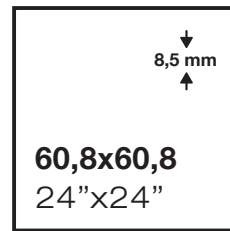

## PACKING & SPECIAL PIECES

	Pc/Cj	M2/Cj	Cj/Pl	M2/Pl	Kg/Cj	Kg/Pl
60,8x60,8	5	1,85	30	55,5	34	1040

	Cód.
60,8x60,8	MP151

**Ver página 581**  
See page 581



**Rodapié**  
Skirting

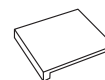

**Peldaño**  
Step





# towns

Interior y Exterior /  
Indoor and Outdoor /

**IN & OUT**

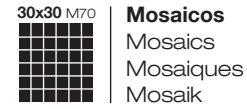
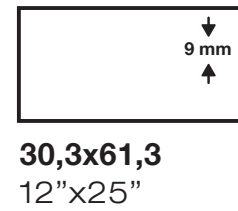
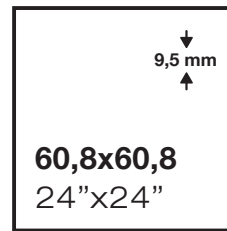

30,3x61,3 12"x25"



rlv nimes white



rlv nimes taupe



rlv nimes pearl



rlv nimes gris

30,3x61,3 12"x25" / 60,8x60,8 24"x24"

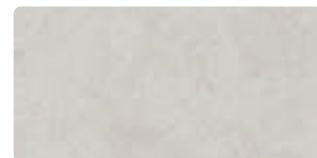

towns white

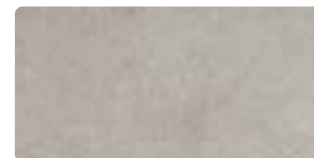

towns taupe



towns pearl

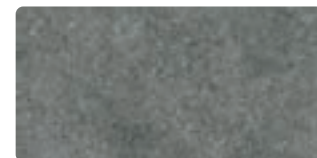

towns gris

## PACKING & SPECIAL PIECES

	Pc/Cj	M2/Cj	Cj/Pl	M2/Pl	Kg/Cj	Kg/Pl
30,3x61,3	7	1,3	40	52	25	1020
60,8x60,8	4	1,48	30	44,4	31,35	960,5

	Cód.
30,3x61,3	MP116
60,8x60,8	MP165
Rlv Nimes	MP115

**Ver página 581**  
See page 581



**Rodapié**  
Skirting

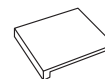

**Peldaño**  
Step

Towns gris / Rlv nimes gris 30,3x61,3 / 12"x25" \_ Towns gris 60,8x60,8 / 24"x24"



white

taupe

pearl

gris



Ural



Ural beige 60,8x60,8 / 24"x24"

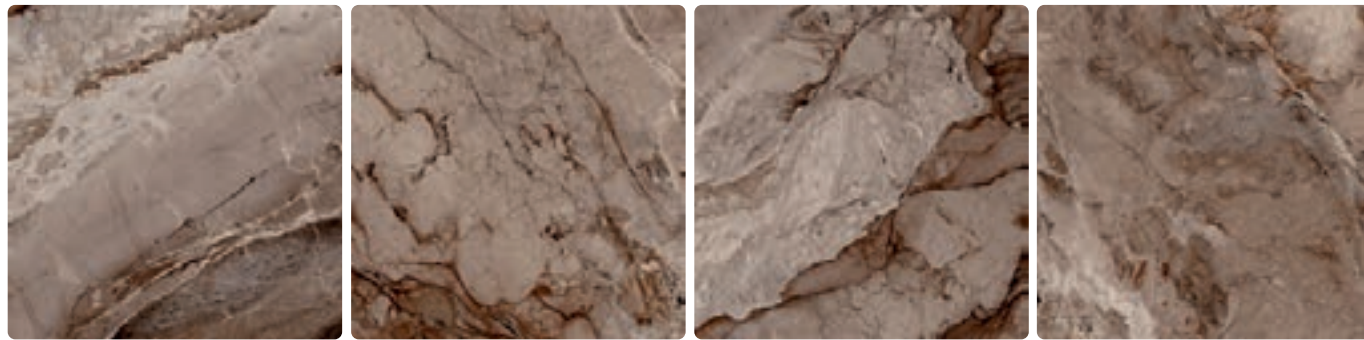
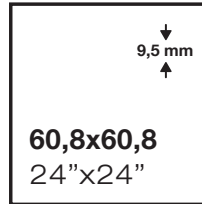

ural beige

PACKING & SPECIAL PIECES

	Pc/Cj	M2/Cj	Cj/Pl	M2/Pl	Kg/Cj	Kg/Pl
60,8x60,8	4	1,48	30	44,4	31,35	960,5
60x120	2	1,44	36	51,84	29,5	1082

	Cód.	Rect.
60,8x60,8	MP161	-
60x120	-	MP181

Ver página 581  
See page 581



Rodapié  
Skirting

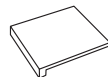

Peldaño  
Step





Xiro



Xiro black 60x120 / 24"x48"

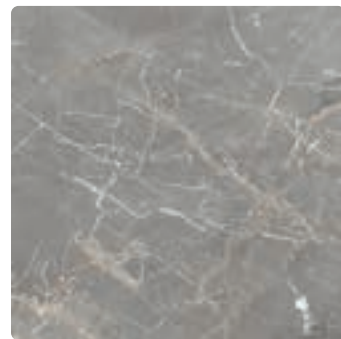
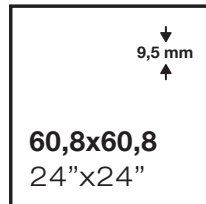

xiro pearl

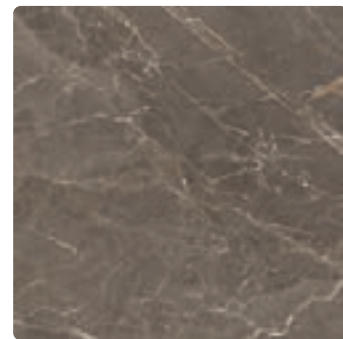

xiro moccha

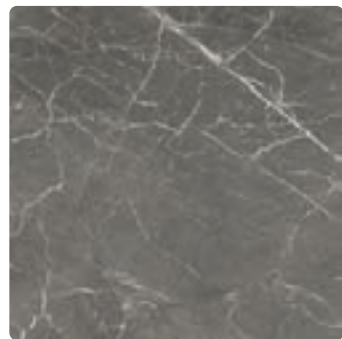

xiro grey

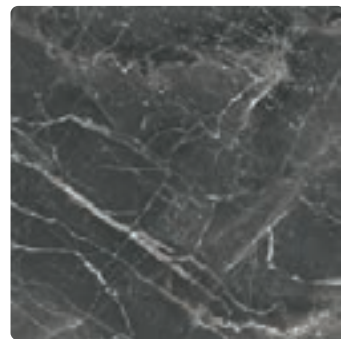

xiro black

PACKING & SPECIAL PIECES

	Pc/Cj	M2/Cj	Cj/Pl	M2/Pl	Kg/Cj	Kg/Pl
60,8x60,8	4	1,48	30	44,4	31,35	960,5
60x120	2	1,44	36	51,84	29,5	1082

	Cód.	Rect.
60,8x60,8	MP161	-
60x120	-	MP181

Ver página 581  
See page 581



Rodapié  
Skirting

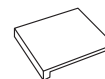



Peldaño  
Step



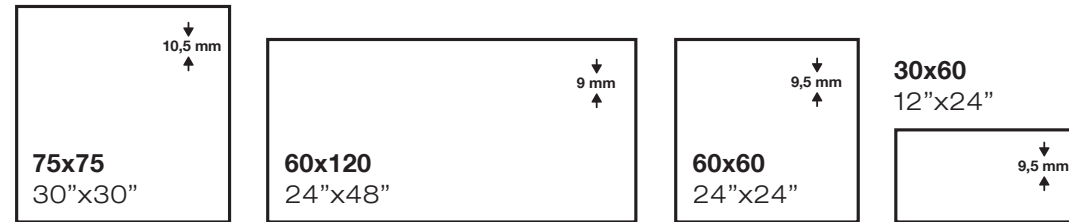

# nature



 Serie susceptible de tratamiento antideslizante bajo demanda.  
 Series susceptible to anti-slip treatment on request.  
 Série sensible au traitement antidérapant sur demande.  
 Serie mit Antirutschbehandlung auf Anfrage.

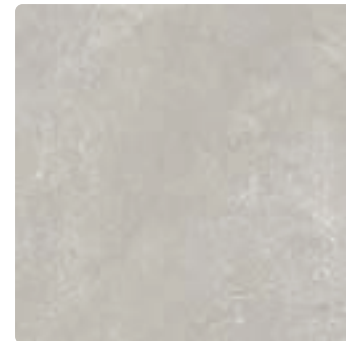

nature perla

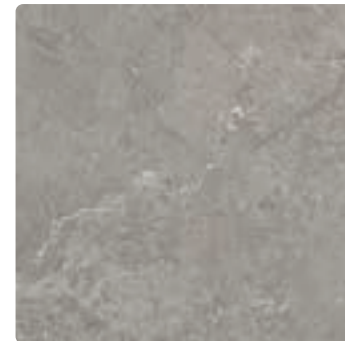

nature gris

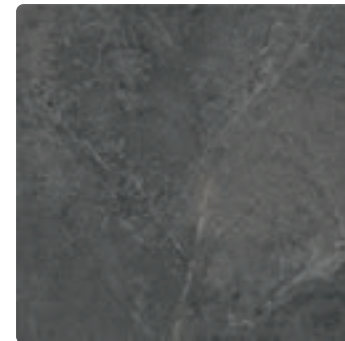

nature grafito

## PACKING & SPECIAL PIECES

	Pc/Cj	M2/Cj	Cj/PI	M2/PI	Kg/Cj	Kg/PI
<b>30x60</b>	6	1,08	48	51,84	23,6	984
<b>60x60</b>	4	1,44	30	43,2	30	920
<b>75x75</b>	3	1,69	30	50,7	41,2	1256
<b>60x120</b>	2	1,44	36	51,84	27,7	1017,2

	Rect.
<b>30x60</b>	MP120
<b>60x60</b>	MP170
<b>75x75</b>	MP190
<b>60x120</b>	MP180

 Ver página 581  
See page 581



Rodapié  
Skirting



Peldaño  
Step

Nature perla 60x60 / 24"x24"





# STATUS



**Serie susceptible de tratamiento antideslizante bajo demanda.**  
 Series susceptible to anti-slip treatment on request.  
 Série sensible au traitement antidérapant sur demande.  
 Serie mit Antirutschbehandlung auf Anfrage.

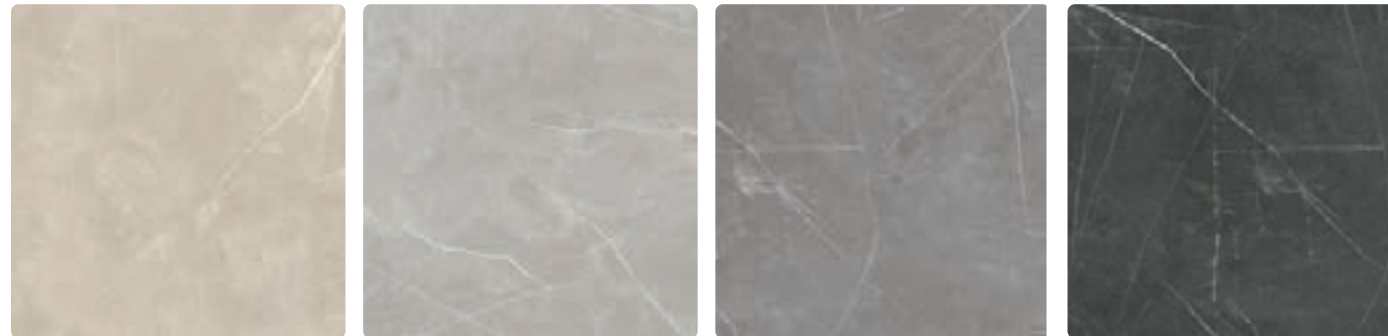

status beige

status perla

status gris

status grafito

## PACKING & SPECIAL PIECES

	Pc/Cj	M2/Cj	Cj/Pl	M2/Pl	Kg/Cj	Kg/Pl
<b>30x60</b>	6	1,08	48	51,84	23,6	984
<b>60x60</b>	4	1,44	30	43,2	30	920
<b>60x120</b>	2	1,44	36	51,84	29,5	1082

	Rect.
<b>30x60</b>	MP120
<b>60x60</b>	MP170
<b>60x120</b>	MP180

**Ver página 581**  
See page 581

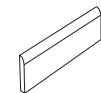

**Rodapié**  
Skirting

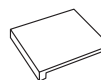

**Peldaño**  
Step

Status grafito 60x60 / 24"x24"





# rafaello



Rafaello 60x120 / 24"x48"

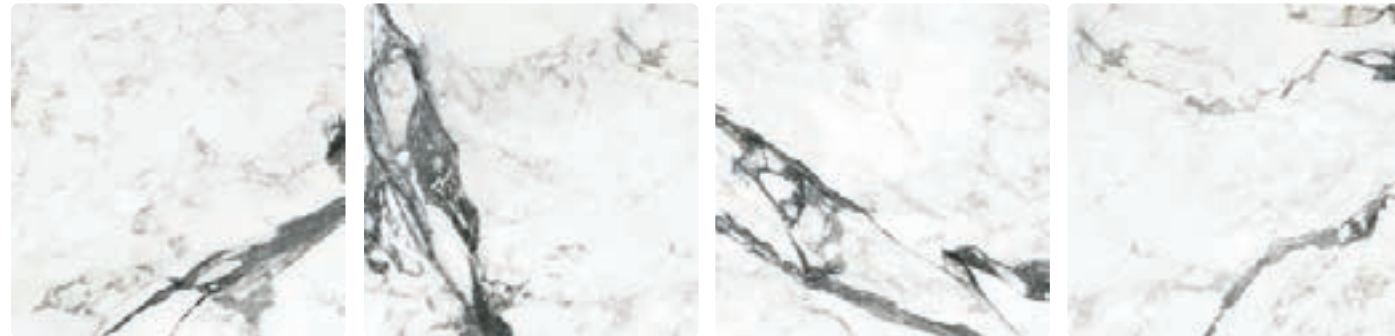
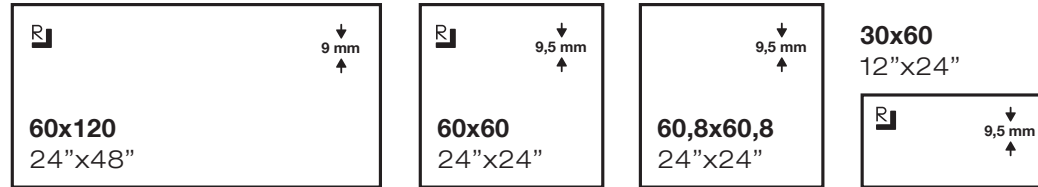

rafaello

## PACKING & SPECIAL PIECES

	Pc/Cj	M2/Cj	Cj/Pl	M2/Pl	Kg/Cj	Kg/Pl
<b>30x60</b>	6	1,08	48	51,84	23,6	984
<b>60x60</b>	4	1,44	30	43,2	30	920
<b>60,8x60,8</b>	4	1,48	30	44,4	31,35	960,5
<b>60x120</b>	2	1,44	36	51,84	29,5	1082

	Cód.	Rect.
<b>30x60</b>	-	MP120
<b>60x60</b>	-	MP170
<b>60,8x60,8</b>	MP160	-
<b>60x120</b>	-	MP180

Ver página 581  
See page 581



Rodapié  
Skirting

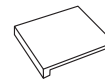

Peldaño  
Step





# shea



Shea 60x120 / 24"x48"

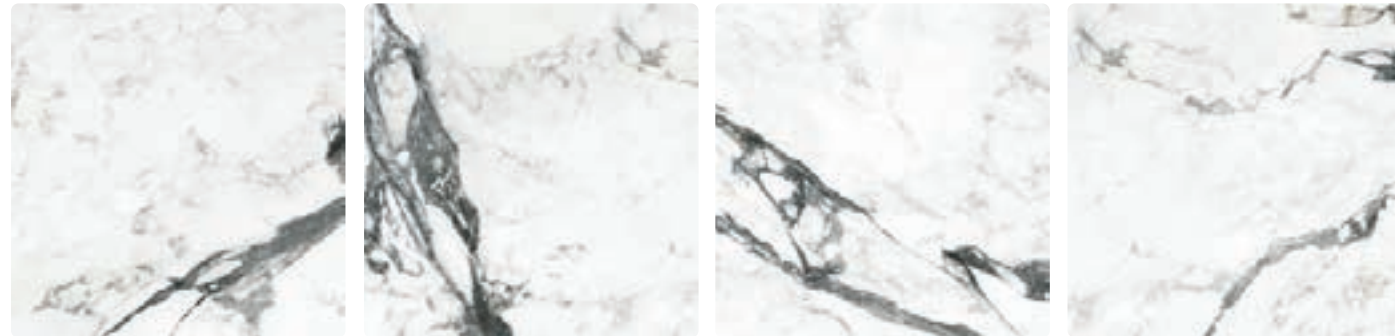
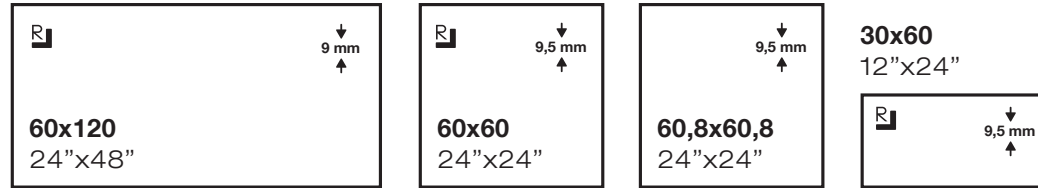

shea

## PACKING & SPECIAL PIECES

	Pc/Cj	M2/Cj	Cj/Pl	M2/Pl	Kg/Cj	Kg/Pl
<b>30x60</b>	6	1,08	48	51,84	23,6	984
<b>60x60</b>	4	1,44	30	43,2	30	920
<b>60,8x60,8</b>	4	1,48	30	44,4	31,35	960,5
<b>60x120</b>	2	1,44	36	51,84	29,5	1082

	Cód.	Rect.
<b>30x60</b>	-	MP120
<b>60x60</b>	-	MP170
<b>60,8x60,8</b>	MP161	-
<b>60x120</b>	-	MP181

**Ver página 581**  
See page 581



**Rodapié**  
Skirting

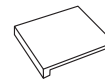

**Peldaño**  
Step

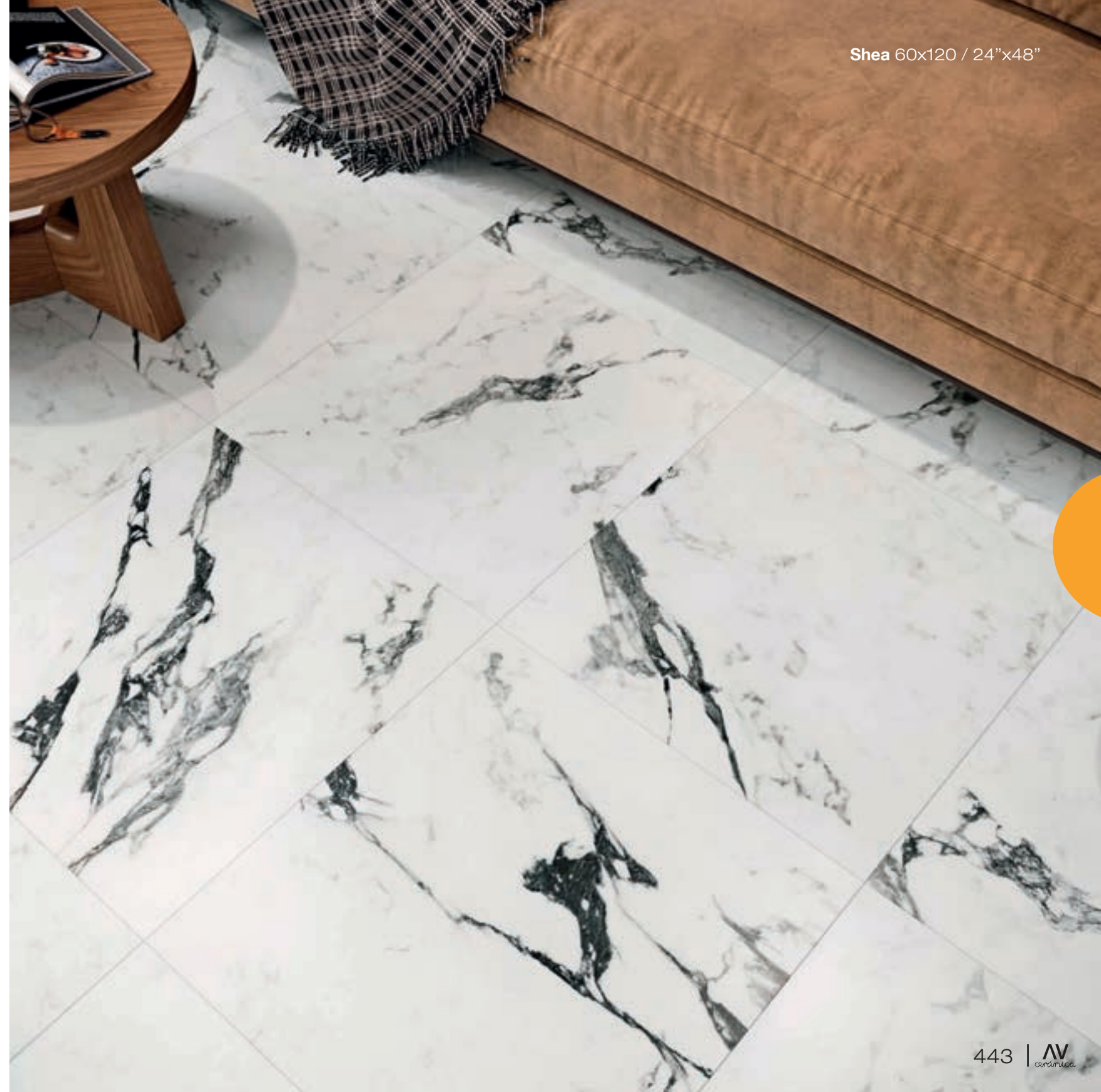



# belgravia



Serie susceptible de tratamiento antideslizante bajo demanda.  
Series susceptible to anti-slip treatment on request.  
Série sensible au traitement antidérapant sur demande.  
Serie mit Antirutschbehandlung auf Anfrage.

Formatos únicamente disponibles en ADZ en los colores Pearl, Beige y Grey

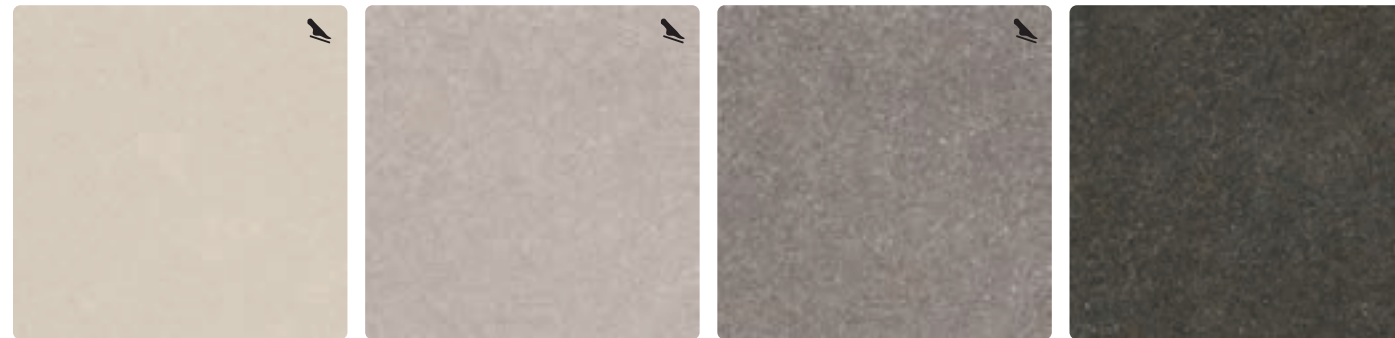

belgravia beige      belgravia pearl      belgravia grey      belgravia anthracite

## PACKING & SPECIAL PIECES

	Pc/Cj	M2/Cj	Cj/PI	M2/PI	Kg/Cj	Kg/PI
<b>30x60</b>	6	1,08	48	51,84	23,6	984
<b>30,3x61,3</b>	7	1,3	40	52	25	1020
<b>33x33</b>	12	1,33	46	61,18	24,35	1140,1
<b>60x60</b>	4	1,44	30	43,2	30	920
<b>60,8x60,8</b>	4	1,48	30	44,4	31,35	960,5
<b>75x75</b>	3	1,69	30	50,7	41,2	1256
<b>60x120</b>	2	1,44	36	51,84	29,5	1082

	Cód.	ADZ
<b>30x60</b>	MP120	-
<b>30,3x61,3</b>	-	MP116
<b>33x33</b>	-	MP105
<b>60x60</b>	MP170	-
<b>60,8x60,8</b>	MP160	-
<b>75x75</b>	PM190	-
<b>60x120</b>	MP180	-

Ver página 581  
See page 581

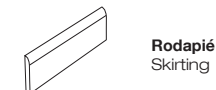

**Rodapié**  
Skirting

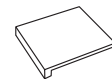

**Peldaño**  
Step

**Peldaño extruido**  
extruded step 32x33,3 / 13"x13"



Belgravia beige 60x120 / 24"x48"





# manhattan

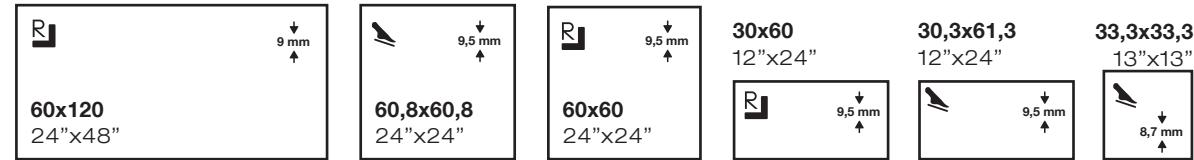

Formato únicamente disponible en ADZ en los colores Pearl, Tan y Grey.

**Serie susceptible de tratamiento antideslizante bajo demanda.**  
 Series susceptible to anti-slip treatment on request.  
 Série sensible au traitement antidérapant sur demande.  
 Serie mit Antirutschbehandlung auf Anfrage.

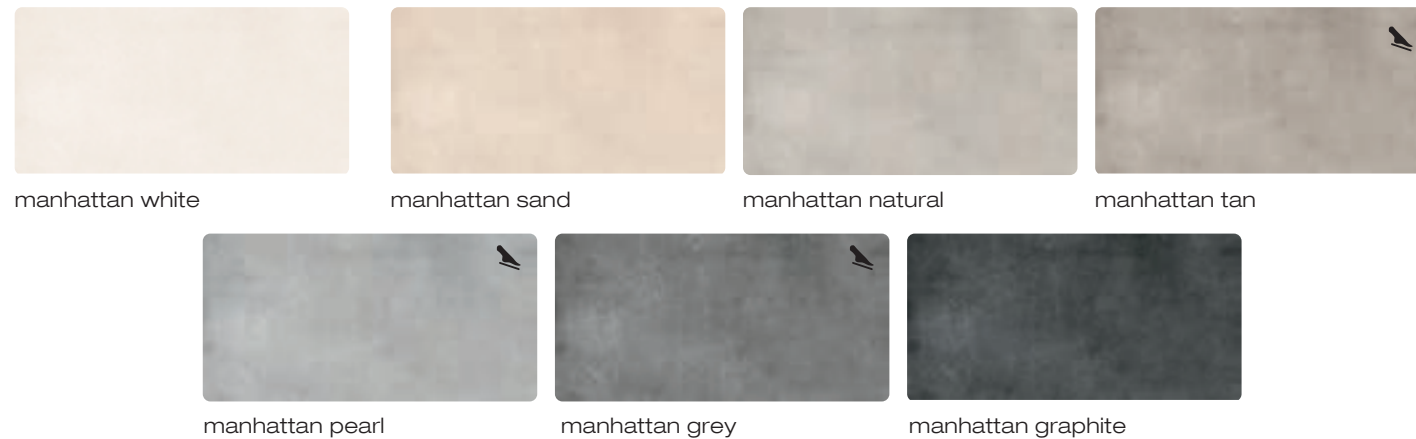

## PACKING & SPECIAL PIECES

	Pc/Cj	M2/Cj	Cj/PI	M2/PI	Kg/Cj	Kg/PI
<b>30x60</b>	6	1,08	48	51,84	23,6	984
<b>30,3x61,3</b>	7	1,3	40	52	25	1020
<b>33x33</b>	12	1,33	46	61,18	24,35	1140,1
<b>60x60</b>	4	1,44	30	43,2	30	920
<b>60,8x60,8</b>	4	1,48	30	44,4	31,35	960,5
<b>60x120</b>	2	1,44	36	51,84	29,5	1082

	Cód.	Rect.	ADZ
<b>30x60</b>	-	MP120	-
<b>30,3x61,3</b>	MP110	-	MP116
<b>33x33</b>	-	-	MP105
<b>60x60</b>	-	MP170	-
<b>60,8x60,8</b>	MP160	-	MP165
<b>60x120</b>	-	MP180	-

**Ver página 581**  
See page 581

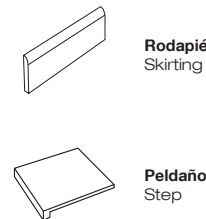

**Rodapié**  
Skirting

**Peldaño**  
Step

Manhattan tan 60x120 / 24" x48"







## DE

Eine Vielzahl von Oberflächen in allen Stilrichtungen.

## FR

Plusieurs finitions dans tous les styles.

## EN

The most versatile formats and styles in glazed porcelain.

## ES

Multitud de acabados en todos los estilos.

bosco • umbria • willow • madeira • deck • forest • bolzano  
makai • mauka • taiga • fanlo • medina • tilos • millenium



# bosco



GRUPO  
Bla



**Recomendable no colocar trabado a mitad de pieza /**  
We do not recommend to lay the tiles brickbond  
(brick-jointed) halfway



**Serie susceptible de tratamiento antideslizante bajo demanda.**  
Series susceptible to anti-slip treatment on request.  
Série sensible au traitement antidérapant sur demande.  
Serie mit Antirutschbehandlung auf Anfrage.



**Los colores crema y gris se pueden suministrar antideslizante.**  
Crema and gris colors can be supplied non-slip.  
Les couleurs crema et gris peuvent être fournies antidérapantes.  
Crema und gris können rutschfest geliefert werden.

8,2 mm  
20x75  
8"x30"

14 faces

## PACKING & SPECIAL PIECES



Ver página 581  
See page 581



Rodapié  
Skirting

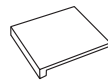

Peldaño  
Step

	Pc/Cj	M2/Cj	Cj/PI	M2/PI	Kg/Cj	Kg/PI
20x75	7	1,05	72	75,6	18,4	1344,8

	Cód.	ADZ
20x75	MP210	MP211

Bosco nogal 20x75 / 8"x30"

blanco



crema



gris

noce

nogal

451



cerámica



# Umbria



GRUPO  
Bla



**Recomendable no colocar trabado a mitad de pieza /**  
We do not recommend to lay the tiles brickbond  
(brick-jointed) halfway



**Serie susceptible de tratamiento antideslizante bajo demanda.**  
Series susceptible to anti-slip treatment on request.  
Série sensible au traitement antidérapant sur demande.  
Serie mit Antirutschbehandlung auf Anfrage.

↓  
8,2 mm  
↑

20x75  
8"x30"

20 faces

## PACKING & SPECIAL PIECES



Ver página 581  
See page 581



Rodapié  
Skirting

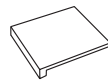

Peldaño  
Step

	Pc/Cj	M2/Cj	Cj/PI	M2/PI	Kg/Cj	Kg/PI
20x75	7	1,05	72	75,6	18,4	1344,8

	Cód.
20x75	MP210

Umbria crema 20x75 / 8"x30"

blanco

crema

gris

453 | AV  
cerámica



# willow



GRUPO  
Bla



**Recomendable no colocar trabado a mitad de pieza /**  
We do not recommend to lay the tiles brickbond  
(brick-jointed) halfway



**Serie susceptible de tratamiento antideslizante bajo demanda.**  
Series susceptible to anti-slip treatment on request.  
Série sensible au traitement antidérapant sur demande.  
Serie mit Antirutschbehandlung auf Anfrage.

↓ 8,2 mm ↑	20 faces
<b>20x75</b> 8"x30"	

## PACKING & SPECIAL PIECES



**Ver página 581**  
See page 581



**Rodapié**  
Skirting

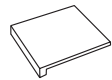

**Peldaño**  
Step

	Pc/Cj	M2/Cj	Cj/PI	M2/PI	Kg/Cj	Kg/PI
<b>20x75</b>	7	1,05	72	75,6	18,4	1344,8

	Cód.	ADZ
<b>20x75</b>	MP210	MP211

Willow natural 20x75 / 8"x30"

perla

ceniza

haya

taupe

natural

455 | AV  
cerámica



# madeira



**GRUPO**  
Bia **Recomendable no colocar trabado a mitad de pieza /**  
We do not recommend to lay the tiles brickbond  
(brick-jointed) halfway

**Serie susceptible de tratamiento antideslizante bajo demanda.**  
Series susceptible to anti-slip treatment on request.  
Série sensible au traitement antidérapant sur demande.  
Serie mit Antirutschbehandlung auf Anfrage.

**Los colores haya y natural se pueden suministrar antideslizante.**  
Haya and natural colors can be supplied non-slip.  
Les couleurs haya et natural peuvent être fournies antidérapantes.  
Haya und natural können rutschfest geliefert werden.

 8,6 mm	22 faces
<b>25x100</b> 10"x40"	

## PACKING & SPECIAL PIECES

**Ver página 581**  
See page 581



**Rodapié**  
Skirting

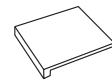

**Peldaño**  
Step

	Pc/Cj	M2/Cj	Cj/PI	M2/PI	Kg/Cj	Kg/PI
<b>25x100</b>	6	1,5	36	54	28,5	1046

	Cód.	ADZ
<b>25x100</b>	MP215	MP216

Madeira natural 20x75 / 8"x30"

nácar

haya

natural

taupe



# deck



**GRUPO**  
Bla

**Recomendable no colocar trabado a mitad de pieza /**  
We do not recommend to lay the tiles brickbond  
(brick-jointed) halfway

**Serie susceptible de tratamiento antideslizante bajo demanda.**  
Series susceptible to anti-slip treatment on request.  
Série sensible au traitement antidérapant sur demande.  
Serie mit Antirutschbehandlung auf Anfrage.

**Deck natural, roble y gris se pueden suministrar antideslizantes.**  
Deck natural, roble and gris colors from collection can be produced on antislip finish.  
Deck natural, roble et gris peuvent être livrés en finition rectifié sur commande.  
Deck natural, roble und gris kann in rutschhemmender Ausführung geliefert werden.

↓  
8,2 mm  
↑

19 faces

**20x75**  
8"x30"

↓  
9 mm  
↑

15 faces

**20x120**  
8"x48"

## PACKING & SPECIAL PIECES

**Ver página 581**  
See page 581



**Rodapié**  
Skirting

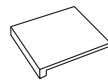

**Peldaño**  
Step

	Pc/Cj	M2/Cj	Cj/PI	M2/PI	Kg/Cj	Kg/PI
<b>20x75</b>	7	1,05	72	75,6	18,4	1344,8
<b>20x120</b>	7	1,68	44	73,92	32	1428

	Cód.	ADZ
<b>20x75</b>	MP210	MP211
<b>20x120</b>	MP225	-

Deck natural 20x120 / 8"x48"

roble

nogal

cerezo

gris

natural

ceniza



# forest



**GRUPO**  
Bla **Recomendable no colocar trabado a mitad de pieza /**  
We do not recommend to lay the tiles brickbond  
(brick-jointed) halfway

**Serie susceptible de tratamiento antideslizante bajo demanda excepto el color antracita.**  
Series susceptible to anti-slip treatment on request except anthracite color.  
Série susceptible de traitement antidérapant sur demande sauf couleur anthracite.  
Serie mit Antirutschbehandlung auf Anfrage, außer Farbe Anthrazit.

**Forest perla y light 20x75 se pueden suministrar antideslizantes.**  
Forest perla and light colors 20x75 from collection can be produced on antislip finish.  
Forest perla et light 20x75 peuvent être livrés en finition rectifié sur commande.  
Forest perla und light 20x75 tkann in rutschhemmender Ausführung geliefert werden.

↓ 8,2 mm  
↑ 18 faces

**20x75**  
8"x30"

↓ 9 mm  
↑ 15 faces

**20x120**  
8"x48"

## PACKING & SPECIAL PIECES

**Ver página 581**  
See page 581



**Rodapié**  
Skirting

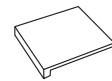

**Peldaño**  
Step

	Pc/Cj	M2/Cj	Cj/PI	M2/PI	Kg/Cj	Kg/PI
<b>20x75</b>	7	1,05	72	75,6	18,4	1344,8
<b>20x120</b>	7	1,68	44	73,92	32	1428

	Cód.	ADZ
<b>20x75</b>	MP210	MP211
<b>20x120</b>	MP225	-

Forest dark 20x75 / 8"x30"

white

perla

light

dark

antracita

461



cerámica



# bolzano



**GRUPO Bla** **Recomendable no colocar trabado a mitad de pieza / We do not recommend to lay the tiles brickbond (brick-jointed) halfway**

**Formato 20x120 susceptible de tratamiento antideslizante bajo demanda.**  
Format 20x120 susceptible to anti-slip treatment on request.  
Format 20x120 sensible au traitement antidérapant sur demande.  
Format 20x120 mit Antirutschbehandlung auf Anfrage.

**Bolzano 20x120 grey y natural se pueden suministrar antideslizantes.**  
Bolzano 20x120 grey and natural colors from collection can be produced on antislip finish.  
Bolzano 20x120 grey et natural peuvent être livrés en finition rectifié sur commande.  
Bolzano 20x120 grey und natural kann in rutschhemmender Ausführung geliefert werden.

**34 faces**

**20x120**  
8"x48"

**32 faces**

**25x150**  
10"x59"

## PACKING & SPECIAL PIECES

**Ver página 581**  
See page 581

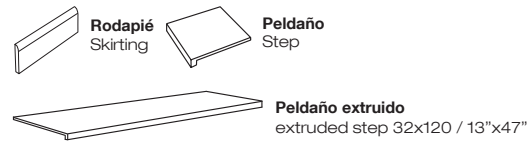

	Pc/Cj	M2/Cj	Cj/PI	M2/PI	Kg/Cj	Kg/PI
<b>20x120</b>	7	1,68	44	73,92	32	1428
<b>25x150</b>	4	1,5	40	60	35	1420

	Cód.	ADZ
<b>20x120</b>	MP225	MP226
<b>25x150</b>	MP235	-
<b>32x120</b>	P067	-



haya

natural

grey

taupe

coffee

**Bolzano natural 20x120 / 8"x48"**



# medina



**GRUPO**  
Bla **Recomendable no colocar trabado a mitad de pieza /**  
We do not recommend to lay the tiles brickbond  
(brick-jointed) halfway

**Serie susceptible de tratamiento antideslizante bajo demanda.**  
Series susceptible to anti-slip treatment on request.  
Série sensible au traitement antidérapant sur demande.  
Serie mit Antirutschbehandlung auf Anfrage.

**Medina ceniza y natural se pueden suministrar antideslizantes.**  
Medina ceniza and natural colors from collection can be produced on antislip finish.  
Medina ceniza et natural peuvent être livrés en finition rectifié sur commande.  
Medina ceniza und natural kann in rutschhemmender Ausführung geliefert werden.

↓  
9 mm  
↑ 34 faces

**20x120**  
8"x48"

## PACKING & SPECIAL PIECES

**Ver página 581**  
See page 581



**Rodapié**  
Skirting

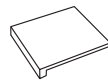

**Peldaño**  
Step

	Pc/Cj	M2/Cj	Cj/PI	M2/PI	Kg/Cj	Kg/PI
<b>20x120</b>	7	1,68	44	73,92	32	1428

	Cód.	ADZ
<b>20x120</b>	MP225	MP226



**Medina natural 20x120 / 8"x48"**

ceniza

haya

nogal

natural

taupe

cerezo



# tilos



CLASE 3

GRUPO Bla



Recomendable no colocar trabado a mitad de pieza / We do not recommend to lay the tiles brickbond (brick-jointed) halfway

**in & out**

Interior y Exterior / Indoor and Outdoor /

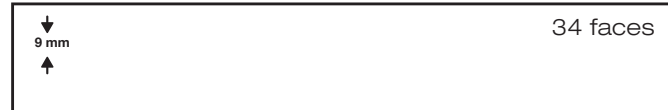

20x120  
8"x48"

## PACKING & SPECIAL PIECES



Ver página 581  
See page 581



Rodapié  
Skirting

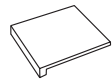

Peldaño  
Step

	Pc/Cj	M2/Cj	Cj/PI	M2/PI	Kg/Cj	Kg/PI
20x120	7	1,68	44	73,92	32	1428

Cód.

20x120 MP225

Tilos natural 20x120 / 8"x48"

blanco

arce

natural

ebano



# makai



**GRUPO**  
Bla **Recomendable no colocar trabado a mitad de pieza /**  
We do not recommend to lay the tiles brickbond  
(brick-jointed) halfway

**Serie susceptible de tratamiento antideslizante bajo demanda.**  
Series susceptible to anti-slip treatment on request.  
Série sensible au traitement antidérapant sur demande.  
Serie mit Antirutschbehandlung auf Anfrage.

**Makai straw, roble y gris se pueden suministrar antideslizantes.**  
Makai straw, roble and gris colors from collection can be produced on antislip finish.  
Makai straw, roble et gris peuvent être livrés en finition rectifié sur commande.  
Makai straw, roble und gris kann in rutschhemmender Ausführung geliefert werden.

↓  
8,5 mm  
↑ 33 faces

**23x120**  
10"x48"

## PACKING & SPECIAL PIECES

**Ver página 581**  
See page 581



**Rodapié**  
Skirting

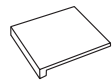

**Peldaño**  
Step

	Pc/Cj	M2/Cj	Cj/PI	M2/PI	Kg/Cj	Kg/PI
<b>23x120</b>	5	1,38	48	66,24	26	1268

	Cód.	ADZ
<b>23x120</b>	MP220	MP221

Makai nogal 23x120 / 10"x48"

ivory

haya

straw

nogal

roble

gris



# mauka



**GRUPO**  
Bla

**Recomendable no colocar trabado a mitad de pieza /**  
We do not recommend to lay the tiles brickbond  
(brick-jointed) halfway



**23x120**  
10"x48"

## PACKING & SPECIAL PIECES

**Ver página 581**  
See page 581



**Rodapié**  
Skirting

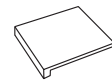

**Peldaño**  
Step

	Pc/Cj	M2/Cj	Cj/PI	M2/PI	Kg/Cj	Kg/PI
<b>23x120</b>	5	1,38	48	66,24	26	1268

	Cód.
<b>23x120</b>	MP220

**Mauka roble 23x120 / 10"x48"**

straw

nogal

roble



# millenium



GRUPO  
Bla



**Recomendable no colocar trabado a mitad de pieza /**  
We do not recommend to lay the tiles brickbond  
(brick-jointed) halfway



**Serie susceptible de tratamiento antideslizante bajo demanda.**  
Serie 20x120 susceptible to anti-slip treatment on request.  
Serie 20x120 sensible au traitement antidérapant sur demande.  
Serie 20x120 mit Antirutschbehandlung auf Anfrage.

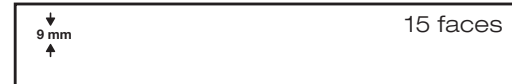

**20x120**  
8"x48"

## PACKING & SPECIAL PIECES



**Ver página 581**  
See page 581



**Rodapié**  
Skirting

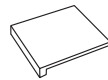

**Peldaño**  
Step

	Pc/Cj	M2/Cj	Cj/PI	M2/PI	Kg/Cj	Kg/PI
<b>20x120</b>	7	1,68	44	73,92	32	1428

	Cód.
<b>20x120</b>	MP225

Millenium natural 20x120 / 8"x48"

crema

natural

miel

noce



# taiga



GRUPO  
Bla



Recomendable no colocar trabado a mitad de pieza /  
We do not recommend to lay the tiles brickbond  
(brick-jointed) halfway



Formato 20x120 susceptible de tratamiento antideslizante bajo demanda.  
Format 20x120 susceptible to anti-slip treatment on request.  
Format 20x120 sensible au traitement antidérapant sur demande.  
Format 20x120 mit Antirutschbehandlung auf Anfrage.



**20x120**  
8"x48"

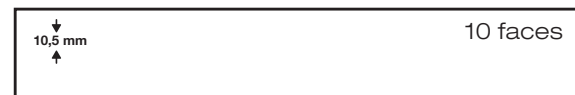

**25x150**  
10"x59"

## PACKING & SPECIAL PIECES



Ver página 581  
See page 581



Rodapié  
Skirting

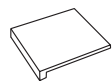

Peldaño  
Step

	Pc/Cj	M2/Cj	Cj/PI	M2/PI	Kg/Cj	Kg/PI
<b>20x120</b>	7	1,68	44	73,92	32	1428
<b>25x150</b>	4	1,5	40	60	35	1420

Cód.

**20x120** MP225

**25x150** MP235

Taiga blanco 20x120 / 8"x48"

blanco

gris

crema

nogal

noce

475



cerámica



# Fanlo



GRUPO  
Bla



Recomendable no colocar trabado a mitad de pieza /  
We do not recommend to lay the tiles brickbond  
(brick-jointed) halfway

↓  
10,5 mm  
↑

10 faces

25x150  
10"x59"

## PACKING & SPECIAL PIECES



Ver página 581  
See page 581



Rodapié  
Skirting

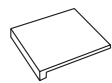

Peldaño  
Step

	Pc/Cj	M2/Cj	Cj/PI	M2/PI	Kg/Cj	Kg/PI
25x150	4	1,5	40	60	35	1420

	Cód.
25x150	MP235

Fanlo haya 25x150 / 10"x59"

ceniza

haya

roble

nogal

477



cerámica



The logo consists of the letters 'AV' in a bold, sans-serif font, with the word 'Cerámica' written in a cursive script below it.The logo consists of the letters 'AV' in a bold, sans-serif font, with the word 'Cerámica' written in a cursive script below it.

red body

floor tile

The logo consists of the letters 'AV' in a bold, sans-serif font, with the word 'Cerámica' written in a cursive script below it.The logo consists of the letters 'AV' in a bold, sans-serif font, with the word 'Cerámica' written in a cursive script below it.

## DE

Bodenbeläge mit einer hohen Dosis Tradition. Modelle und Formate, die alle Arten von jeder Ambiente.

## FR

Surfaces avec une forte dose de tradition. Modèles et formats pour habiller et pour embellir tous types d'environnements.

## EN

Floor tile come along a high dose of tradition. A myriad of collections and formats for all environments.

## ES

Pavimento con alta dosis de tradición. Modelos y formatos para vestir todo tipo de ambientes.

foresta • frey • fusta • tioga • matt collection • glossy collection



# foresta



20x60  
8"x24"

↓  
9,5 mm  
↑

## PACKING & SPECIAL PIECES

Ver página 581  
See page 581



	Pc/Cj	M2/Cj	Cj/PI	M2/PI	Kg/Cj	Kg/PI
20x60	9	1,08	80	86,4	21,08	1706,4
	Cód.					
20x60	MG120					



foresta brown



foresta grey

Foresta brown 20x60 / 8"x24"



frey



RB



GRUPO Blla

20x60  
8"x24"

9,5 mm

PACKING & SPECIAL PIECES



Ver página 581  
See page 581



Rodapié Skirting

	Pc/Cj	M2/Cj	Cj/PI	M2/PI	Kg/Cj	Kg/PI
20x60	9	1,08	80	86,4	21,08	1706,4
<b>Cód.</b>						
20x60	MG120					



frey arce



frey haya



frey roble

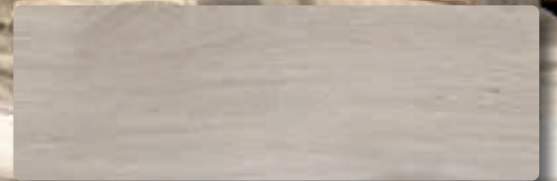

frey perla



frey plata



frey gris

Frey roble 20x60 / 8"x24"



# FUSTA



RB



GRUPO Blla

**20x60**  
8"x24"

↓  
9,5 mm  
↑

**PACKING & SPECIAL PIECES**



Ver página 581  
See page 581

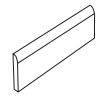

Rodapié Skirting

	Pc/Cj	M2/Cj	Cj/Pl	M2/Pl	Kg/Cj	Kg/Pl
<b>20x60</b>	9	1,08	80	86,4	21,08	1706,4
	<b>Cód.</b>					
<b>20x60</b>	MG120					



fusta nogal



fusta roble



fusta wengue

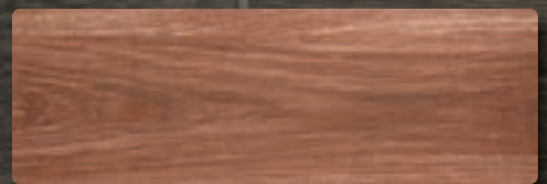

fusta cerezo

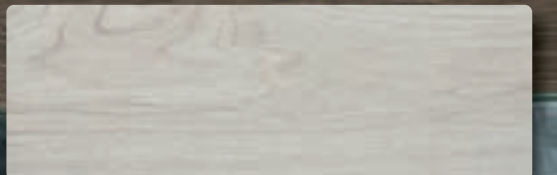

fusta haya

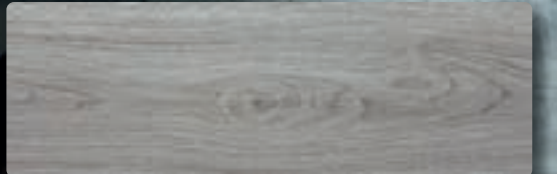

fusta marengo



fusta grafito



fusta musgo

Fusta wengue 20x60 / 8"x24"



# tioga



RB



GRUPO Billa

20x60  
8"x24"

↓  
9,5 mm  
↑

## PACKING & SPECIAL PIECES



Ver página 581  
See page 581



Rodapié  
Skirting

	Pc/Cj	M2/Cj	Cj/Pl	M2/Pl	Kg/Cj	Kg/Pl
20x60	9	1,08	80	86,4	21,08	1706,4

Cód.

20x60 MG120

tioga crema

tioga nogal

tioga noce

tioga blanco

tioga gris

Tioga crema 20x60 / 8"x24"



# matte collection

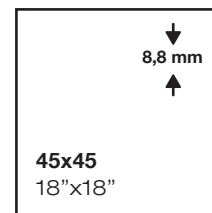

## PACKING & SPECIAL PIECES

Ver página 581  
See page 581



	Pc/Cj	M2/Cj	Cj/PI	M2/PI	Kg/Cj	Kg/PI
45x45	7	1,42	52	73,84	26	1372
Cód.						
45x45	MG110					

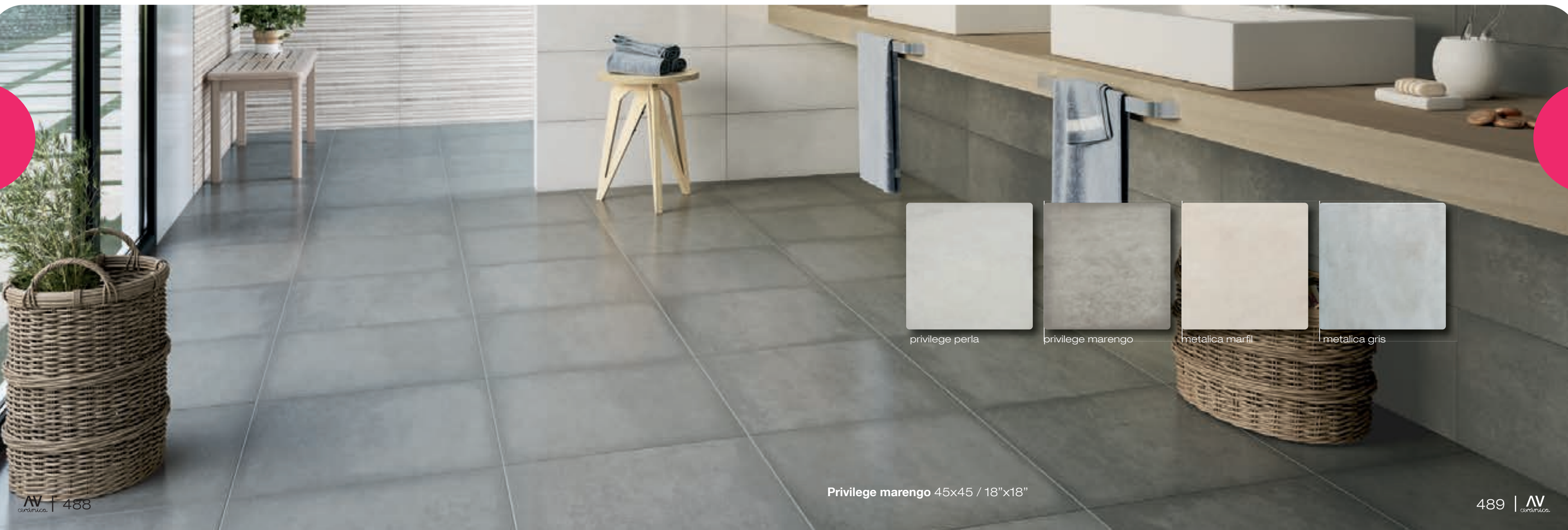

Privilege marengo 45x45 / 18"x18"



# glossy collection



RB



CMYK



TVT



GRUPO Billa

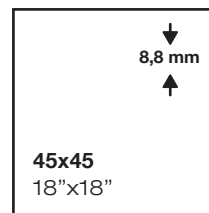

## PACKING & SPECIAL PIECES



Ver página 581  
See page 581



Rodapié  
Skirting

	Pc/Cj	M2/Cj	Cj/Pl	M2/Pl	Kg/Cj	Kg/Pl
<b>45x45</b>	7	1,42	52	73,84	26	1372

Cód.

**45x45** MG110

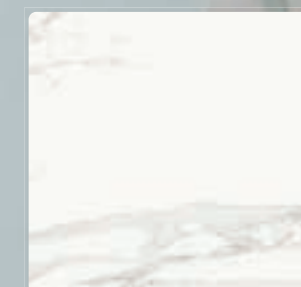

forum blanco

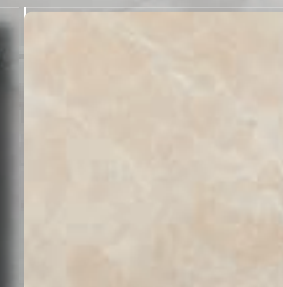

ágora marfil

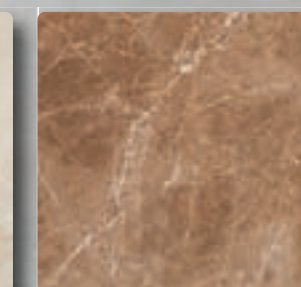

ágora noce

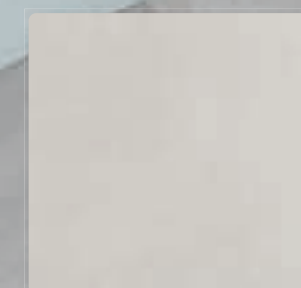

davis perla

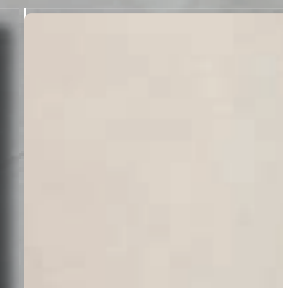

davis crema

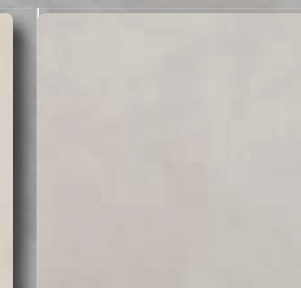

davis gris

Davis gris 45x45 / 18"x18"



red body

wall tile

## DE

Lösungen für jeden  
Bedarf.

bergen • byron • giro • keon • ágora • azur • dafne • londra • marblebrick • sonora  
algher • flat • kairos • laos • memphis • miller • reness • rodano • stuc • murettos

## FR

Des solutions pour  
répondre à tous les  
besoins.

## EN

Tile intended to offer and  
appropriate solution for any  
need.

bethel • flat • graft • artan • avart • calacatta • danos • gualdo • lengo • north  
pisa • sener • blancos

## ES

Soluciones para dar  
respuesta a cualquier  
necesidad.



# bergen



RB



GRUPO  
Bill

**20x60**  
8"x24"

↓  
9,4 mm  
↑

**PAVIMENTO RECOMENDADO**  
recommended floor tile

■ FREY / 20X60 cm

ARCE

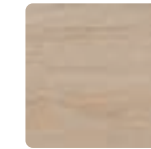

ROBLE



PERLA



**PACKING & SPECIAL PIECES**

	Pc/Cj	M2/Cj	Cj/PI	M2/PI	Kg/Cj	Kg/PI
<b>20x60</b>	9	1,08	80	86,4	17,9	1452
<b>20x60 Rlv</b>	8	0,96	80	76,8	18	1460
	<b>Cód.</b>		<b>Cód.</b>		<b>Cód.</b>	
<b>Bergen</b>	MR140	<b>Rlv Flam</b>	MR145	<b>Rlv Levita</b>	MR145	

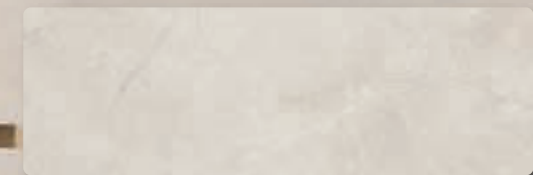

bergen marfil

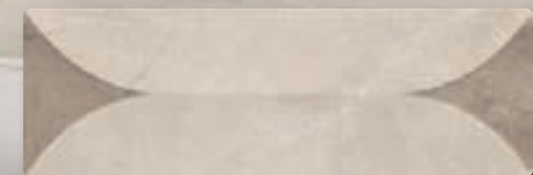

riv flam marfil

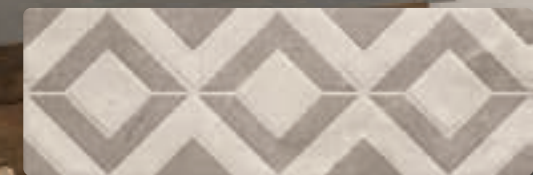

riv levita marfil

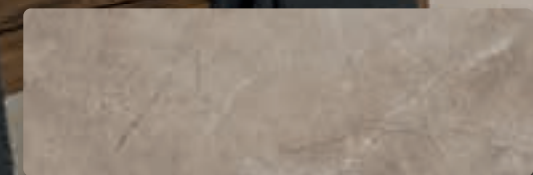

bergen arena



bergen perla



riv flam perla



riv levita perla



bergen gris

Bergen marfil / Riv Flam marfil 20x60 / 8"x24"



byron



RB



GRUPO BIII

20x60  
8"x24"

↓  
9,4 mm  
↑

**PAVIMENTO RECOMENDADO**  
recommended floor tile

■ **BERLÍN / 45X45 cm**

**FUSTA / 20X60 cm**

CREMA

GRIS

GRAFITO

NOGAL

ROBLE



**PACKING & SPECIAL PIECES**

	Pc/Cj	M2/Cj	Cj/PI	M2/PI	Kg/Cj	Kg/PI
<b>20x60</b>	9	1,08	80	86,4	17,9	1452
	<b>Cód.</b>		<b>Cód</b>			
<b>Byron</b>	MR140	<b>Dc Howe</b>	MR146			

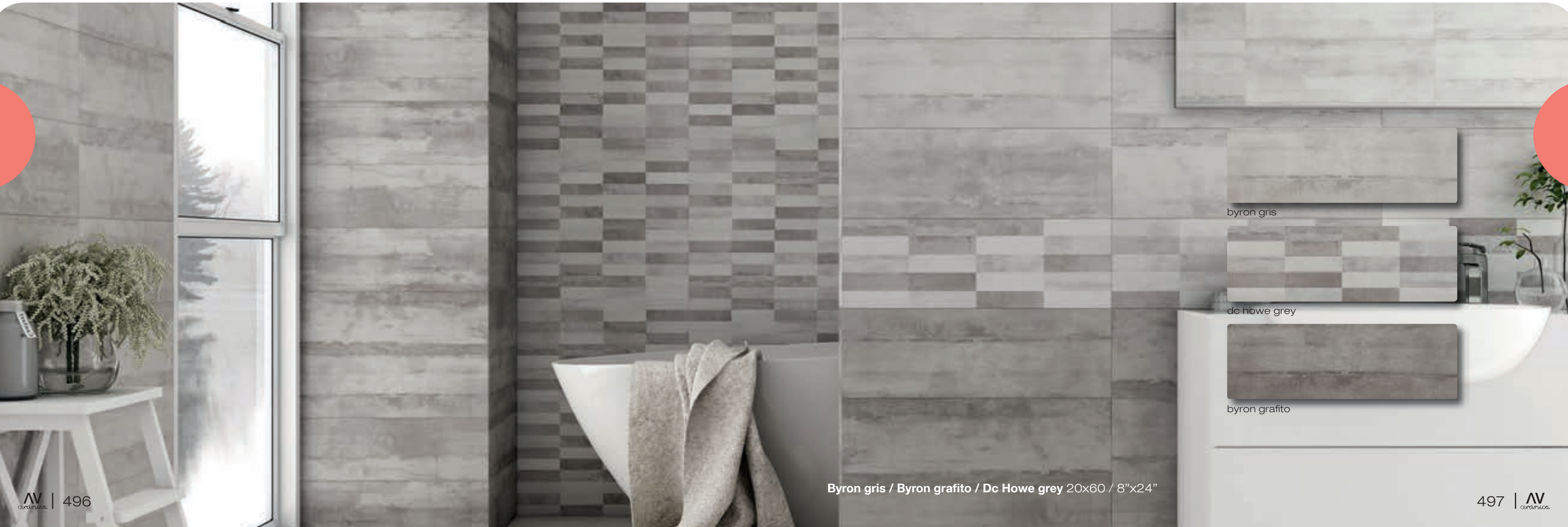

byron gris

dc howe grey

byron grafito

Byron gris / Byron grafito / Dc Howe grey 20x60 / 8"x24"



giro



RB



GRUPO BIII

20x60  
8"x24"

↓  
9,4 mm  
↑

PAVIMENTO COORDINADO  
coordinated floor tile

KAMEN / 60,8X60,8 cm

MARFIL

PERLA

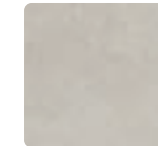

PACKING & SPECIAL PIECES

	Pc/Cj	M2/Cj	Cj/PI	M2/PI	Kg/Cj	Kg/PI
20x60	9	1,08	80	86,4	17,9	1452
20x60 Rlv	8	0,96	80	76,8	18	1460

	Cód.		Cód		Cód
Giro	MR140	Rlv Lido	MR145	Rlv Rhom	MR145



giro marfil

rlv rhom marfil

rlv lido marfil

giro arena

giro perla

rlv rhom perla

rlv lido perla

giro gris

Giro perla / Rlv Lido perla 20x60 / 8"x24"



# keon



RB



GRUPO  
BIII

20x60  
8"x24"  
9,4 mm

**PAVIMENTO COORDINADO**  
coordinated floor tile

■ MUTAZ / 60,8X60,8 cm

BLANCO CREMA GRIS MARENGO



**IN &  
OUT**

## PACKING & SPECIAL PIECES

	Pc/Cj	M2/Cj	Cj/PI	M2/PI	Kg/Cj	Kg/PI
<b>20x60</b>	9	1,08	80	86,4	17,9	1452
<b>20x60 Rlv</b>	8	0,96	80	76,8	18	1460
	<b>Cód.</b>		<b>Cód.</b>		<b>Cód.</b>	
<b>Keon</b>	MR140	<b>Rlv Keon</b>	MR145	<b>Rlv Natu</b>	MR145	



keon blanco



rlv natu crema

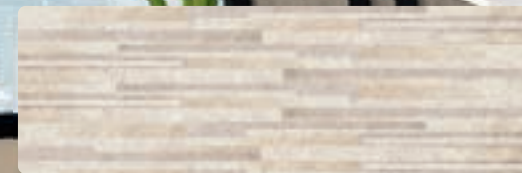

rlv keon crema

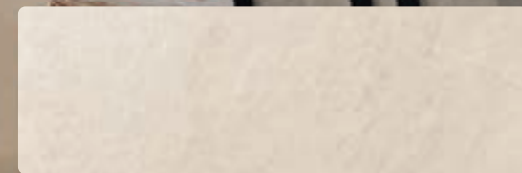

keon crema

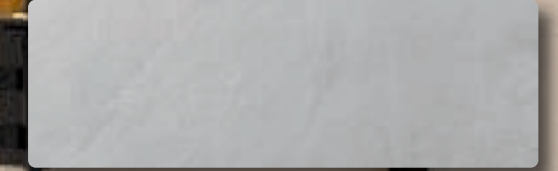

keon gris



rlv natu gris



rlv keon gris

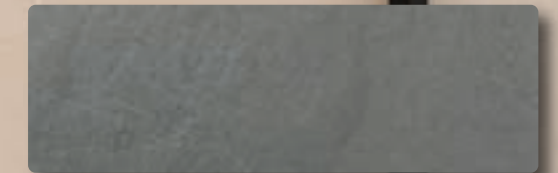

keon marengo

Keon crema / Rlv natu crema 20x60 / 8"x24"



# ágora



RB



GRUPO BIII

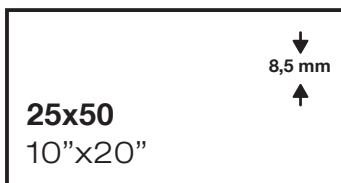

### PAVIMENTO COORDINADO

coordinated floor tile

● **ÁGORA** / 45X45 cm

MARFIL

NOCE



### PIEZAS ESPECIALES

special pieces

**ÁGORA NOCE**

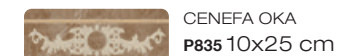

### PACKING & SPECIAL PIECES

	Pc/Cj	M2/Cj	Cj/PI	M2/PI	Kg/Cj	Kg/PI
<b>25x50</b>	16	2	48	96	26,5	1292
<b>25x50 Riv</b>	14	1,75	48	84	25,8	1258,4
	Cód.		Cód		Cód	
<b>Ágora</b>	MR110	<b>Dc Ágora</b>	MR116	<b>Dc Ágora Vent.</b>	MR116	



ágora marfil

dc ágora marfil

dc ágora ventana marfil

ágora noce

dc ágora noce

dc ágora ventana noce

Ágora marfil / Dc Ágora marfil 25x50 / 10"x20"



azur



RB



GRUPO BIII



**PAVIMENTO COORDINADO**  
coordinated floor tile

● **FORUM / 45X45 cm**

BLANCO



**PIEZAS ESPECIALES**  
special pieces

**AZUR**



ZÓCALO OKA  
P830 10x25 cm



MOLDURA OKA  
P825 4x25 cm



CENEFA OKA  
P835 10x25 cm



INSERTO OKA  
P820 10,5x14,5 cm

**PACKING & SPECIAL PIECES**

	Pc/Cj	M2/Cj	Cj/PI	M2/PI	Kg/Cj	Kg/PI
<b>25x50</b>	16	2	48	96	26,5	1292
<b>25x50 Rlv</b>	14	1,75	48	84	25,8	1258,4

	Cód.	Cód	Cód
<b>Azur</b>	MR110	<b>Dc Azur</b>	MR116 <b>Dc Azur Vent.</b>



azur



dc azur



dc azur ventana

Azur / Dc Azur 25x50 / 10"x20"



# dafne



RB



GRUPO  
BIII



**Diferentes diseños en una caja.**  
Different designs in one box.  
Différents modèles dans une seule boîte.  
Verschiedene Designs in einer Box.

**PAVIMENTO COORDINADO**  
coordinated floor tile

■ **RODANO** / 60,8X60,8 cm



**PACKING & SPECIAL PIECES**

	Pc/Cj	M2/Cj	Cj/PI	M2/PI	Kg/Cj	Kg/PI
<b>25x50</b>	16	2	48	96	26,5	1292
<b>25x50 Rlv</b>	14	1,75	48	84	25,8	1258,4
	Cód.			Cód		Cód
<b>Dafne</b>	MR110	<b>Rlv Ladón / Tierra</b>		MR115	<b>Dc Omeya</b>	MR116

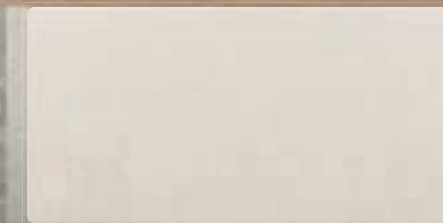

dafne marfil

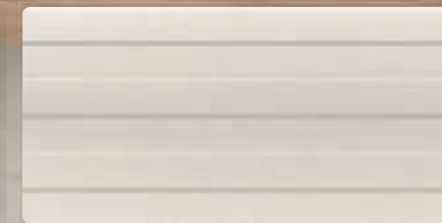

rlv ladon marfil

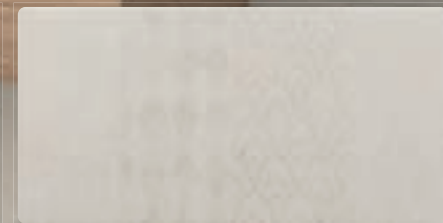

dc omeya marfil \*

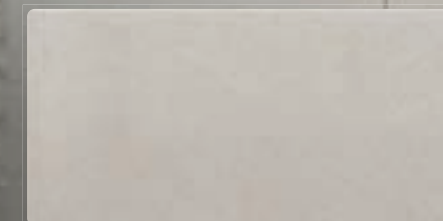

dafne natural

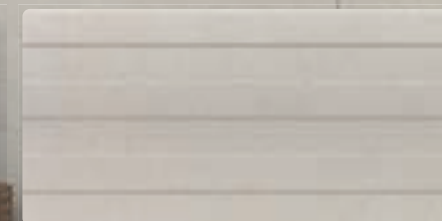

rlv ladon natural

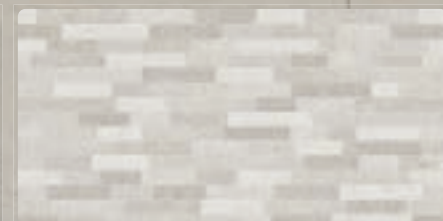

rlv tierra natural

Dafne marfil / Rlv Tierra natural 25x50 / 10"x20"



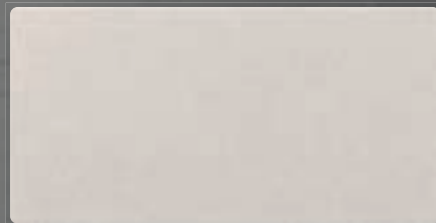

dafne perla

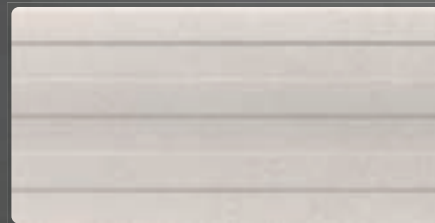

rlv ladon perla

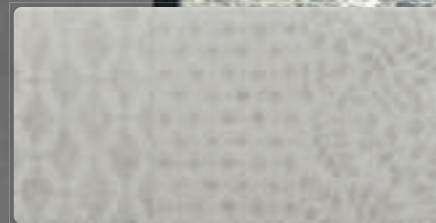

dc omeya perla\*

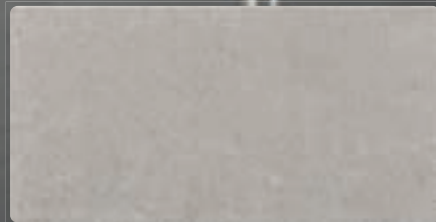

dafne gris

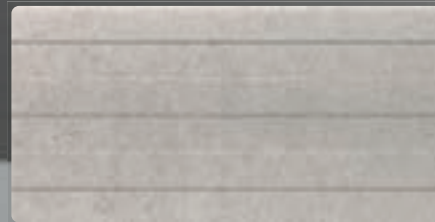

rlv ladon gris

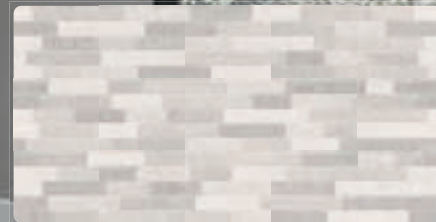

rlv tierra gris

Dafne gris / Rlv Ladon gris 25x50 / 10"x20"



# londra



RB



GRUPO  
Bill

↓  
8,5 mm  
↑

**25x50**  
10"x20"

**PAVIMENTO RECOMENDADO**  
recommended floor tile

■ **TIOGA / 20X60 cm**

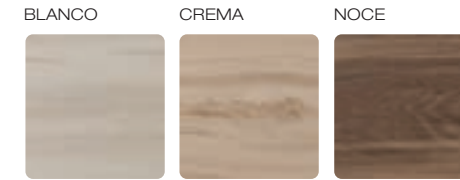

**PACKING & SPECIAL PIECES**

	Pc/Cj	M2/Cj	Cj/PI	M2/PI	Kg/Cj	Kg/PI
<b>25x50</b>	16	2	48	96	26,5	1292
<b>25x50 Riv</b>	14	1,75	48	84	25,8	1258,4

	Cód.		Cód		Cód
<b>Londra</b>	MR110	<b>Rlv Croy</b>	MR115	<b>Dc Londra</b>	MR116



londra crema



rlv croy crema

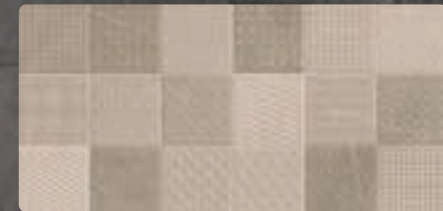

dc londra crema

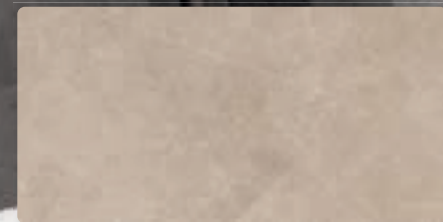

londra noce

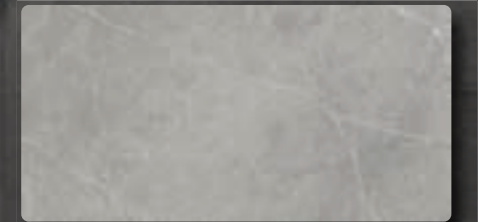

londra perla



rlv croy perla



dc londra perla

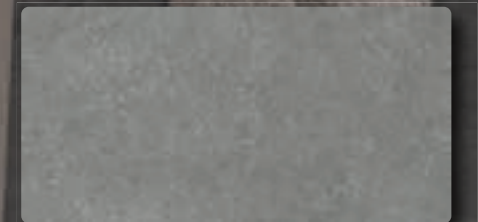

londra gris

**Londra perla / Dc Londra perla 25x50 / 10"x20"**



# marblebrick



RB



GRUPO BIII



## PAVIMENTO RECOMENDADO

recommended floor tile

### MILLENIUM / 20X120 cm

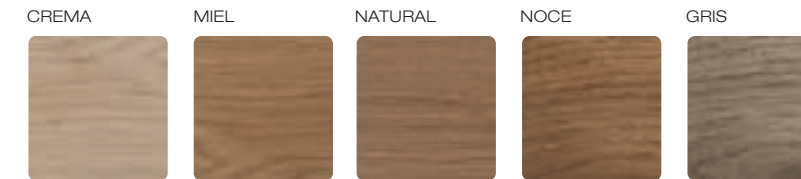

## PACKING & SPECIAL PIECES

	Pc/Cj	M2/Cj	Cj/PI	M2/PI	Kg/Cj	Kg/PI
<b>25x50</b>	14	1,75	48	84	25,8	1258,4
	Cód.					
<b>Marblebrick</b>	MR120					



marblebrick blanco

marblebrick perla

marblebrick bronce

marblebrick antracita

marblebrick brown

marblebrick mix

Marblebrick blanco 25x50 / 10"x20"



# Sonora



RB



GRUPO BIII



### PAVIMENTO RECOMENDADO

recommended floor tile

■ FREY / 20X60 cm

ARCE



ROBLE



PERLA



### DC SONORA

sonora series

25X50 cm

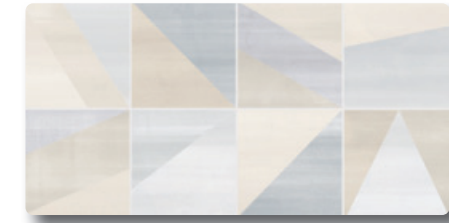

### PACKING & SPECIAL PIECES

	Pc/Cj	M2/Cj	Cj/PI	M2/PI	Kg/Cj	Kg/PI
<b>25x50</b>	16	2	48	96	26,5	1292
<b>25x50 Riv</b>	14	1,75	48	84	25,8	1258,4

	Cód.		Cód		Cód
<b>Sonora</b>	MR110	<b>Rlv Sonora</b>	MR115	<b>Dc Sonora</b>	MR116

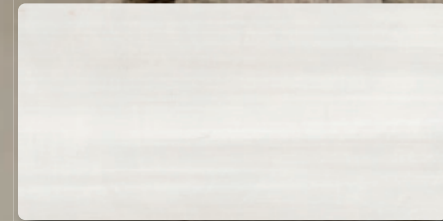

sonora marfil



rlv sonora crema

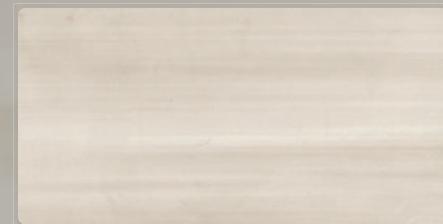

sonora crema



sonora perla

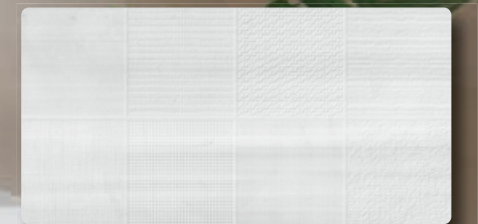

rlv sonora perla



sonora gris

Sonora crema / Rlv sonora crema 25x50 / 10"x20"



# algher



RB



GRUPO BIII

25x70  
10"x28"

↓  
8,5 mm  
↑

**PAVIMENTO COORDINADO**  
coordinated floor tile

■ **KAMEN** / 60,8X60,8 cm

PERLA

MARFIL

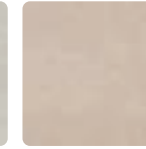

## PACKING & SPECIAL PIECES

	Pc/Cj	M2/Cj	Cj/PI	M2/PI	Kg/Cj	Kg/PI
<b>25x70</b>	9	1,58	64	101,12	24,64	1596,96
<b>25x70 Riv</b>	9	1,58	56	88,48	24,64	1399,84
	Cód.		Cód			
<b>Algher</b>	MR150	<b>Riv Algher</b>	MR155			

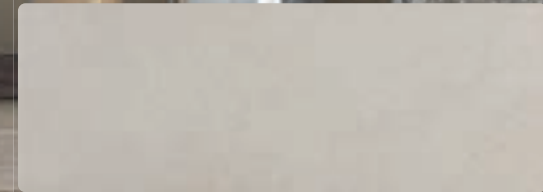

algher marfil



riv algher arena



algher arena

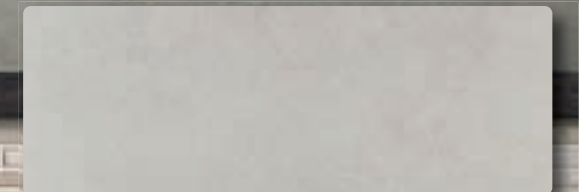

algher perla

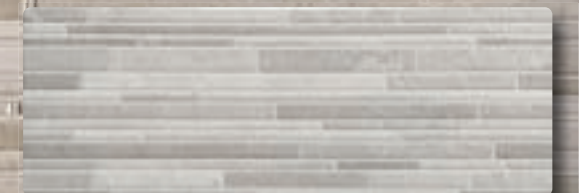

riv algher perla



algher gris

Algher arena / Riv Algher arena 25x70 / 10"x28"



# Flat



RB



GRUPO  
BIII

25x70  
10"x28"

↓  
8,5 mm  
↑

## PAVIMENTO RECOMENDADO

recommended floor tile

■ **TIOGA** / 20X60 cm

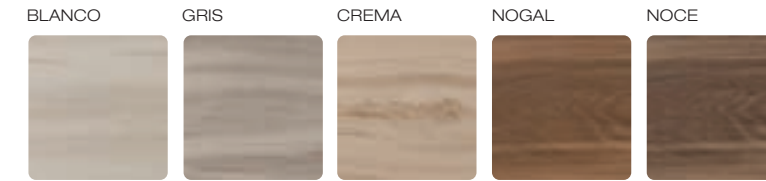

## PACKING & SPECIAL PIECES

	Pc/Cj	M2/Cj	Cj/PI	M2/PI	Kg/Cj	Kg/PI
<b>25x70</b>	9	1,58	64	101,12	24,64	1596,96
<b>25x70 Riv</b>	9	1,58	56	88,48	24,64	1399,84
	Cód.		Cód.		Cód.	
<b>Flat</b>	MR150	<b>Ondas</b>	MR155	<b>Liner</b>	MR155	

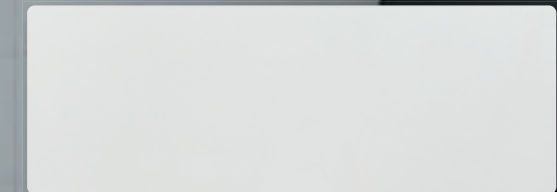

flat blanco mate

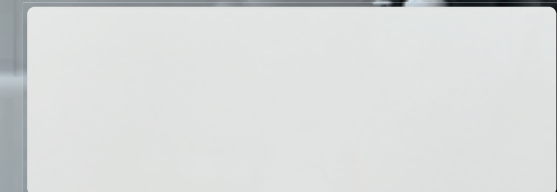

flat blanco brillo

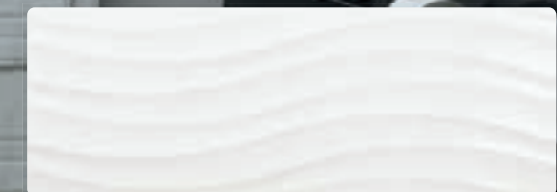

ondas blanco brillo



liner blanco brillo

Flat blanco brillo / Ondas blanco brillo 25x70 / 10"x28"



# kairos



RB



GRUPO BIII

25x70  
10"x28"

↓  
8,5 mm  
↑

**PAVIMENTO COORDINADO**  
coordinated floor tile

■ MUTAZ / 60,8X60,8 cm

**IN & OUT**

BLANCO    CREMA    GRIS    MARENGO



**PACKING & SPECIAL PIECES**

	Pc/Cj	M2/Cj	Cj/PI	M2/PI	Kg/Cj	Kg/PI
<b>25x70</b>	9	1,58	64	101,12	24,64	1596,96
<b>25x70 Riv</b>	9	1,58	56	88,48	24,64	1399,84

	Cód.	
<b>Kairos</b>	MR150	<b>Riv Cronos</b> MR155

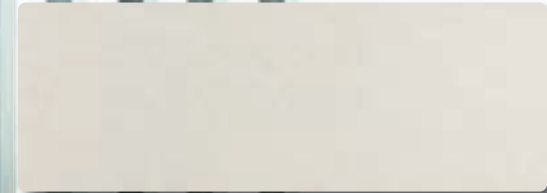

kairos blanco



riv cronos crema

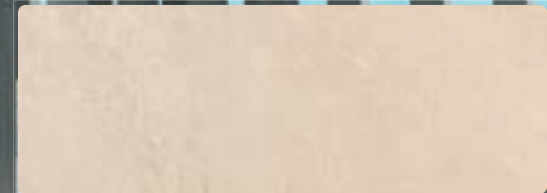

kairos crema

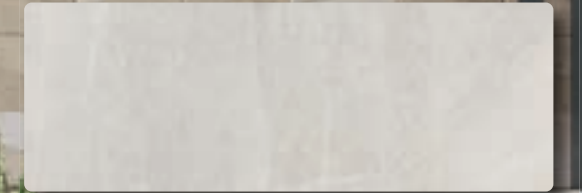

kairos gris



riv cronos marengo

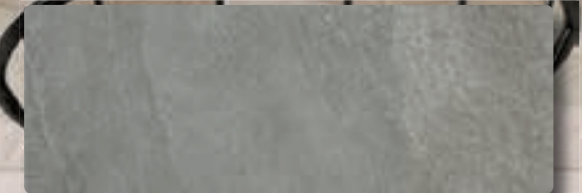

kairos marengo

**Kairos blanco / Riv Cronos crema 25x70 / 10"x28"**



laos



RB



GRUPO BIII

25x70  
10"x28"

↓  
8,5 mm  
↑

**PAVIMENTO COORDINADO**  
coordinated floor tile

■ SANDER / 60,8X60,8 cm

**IN & OUT**

BLANCO    MARFIL    PERLA    SILVER



**PACKING & SPECIAL PIECES**

	Pc/Cj	M2/Cj	Cj/PI	M2/PI	Kg/Cj	Kg/PI
<b>25x70</b>	9	1,58	64	101,12	24,64	1596,96
<b>25x70 Riv</b>	9	1,58	56	88,48	24,64	1399,84

	Cód.	Cód.
<b>Laos</b>	MR150	<b>Rlv Luang</b> MR155



laos marfil

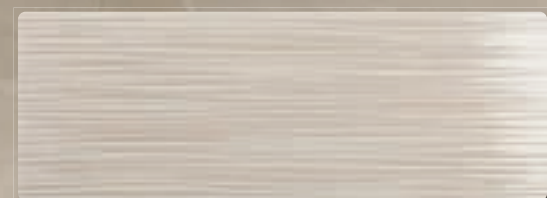

rlv luang marfil

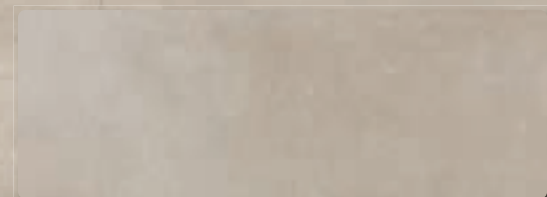

laos noce

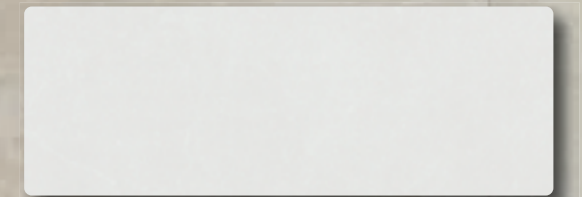

laos blanco

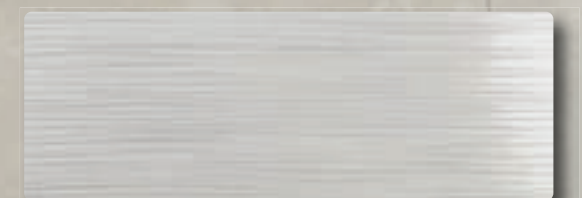

rlv luang perla

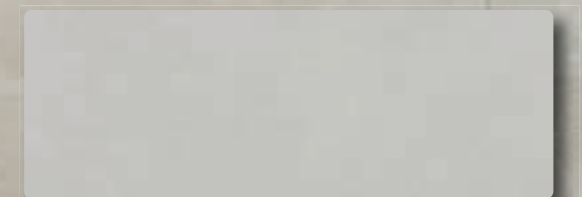

laos perla



Laos noce / Rlv Luang marfil 25x70 / 10"x28"



# memphis



RB



GRUPO BIII

25x70  
10"x28"

↓  
8,5 mm  
↑



**Dc Dim no tiene continuidad.**  
Dc Dim has no continuity.  
Dc Dim n'a pas de continuité.  
Dc Dim hat keine Kontinuität.

**PAVIMENTO RECOMENDADO**  
recommended floor tile

■ MADEIRA / 25X100 cm

NÁCAR



HAYA

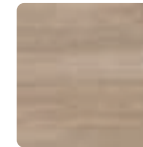

NATURAL

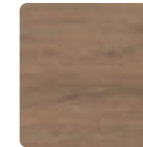

TAUPE

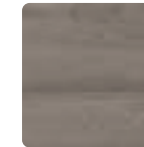

**PACKING & SPECIAL PIECES**

	Pc/Cj	M2/Cj	Cj/PI	M2/PI	Kg/Cj	Kg/PI
<b>25x70</b>	9	1,58	64	101,12	24,64	1596,96
	<b>Cód.</b>		<b>Cód</b>			
<b>Memphis</b>	MR150	<b>Dc Dim</b>	MR155			

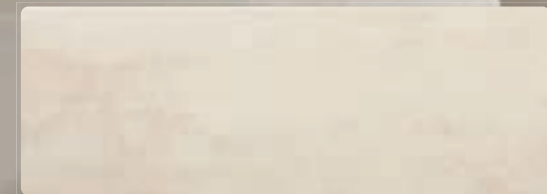

memphis crema



\*dc dim crema

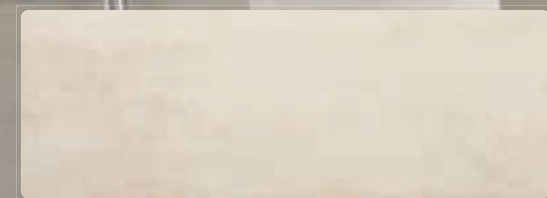

memphis crema

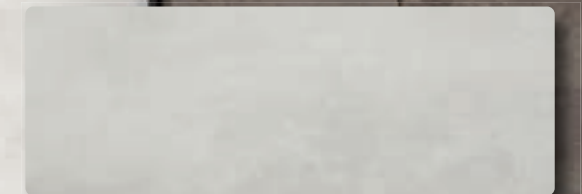

memphis perla

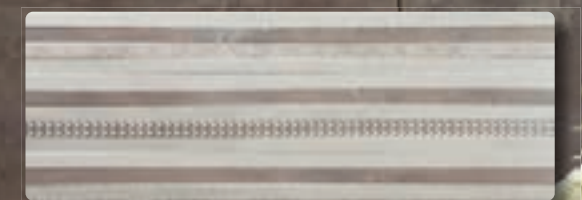

\*dc dim



memphis óxido

Memphis crema / Memphis óxido / Dc Dim 25x70 / 10"x28"



miler



RB



GRUPO BIII

25x70  
10"x28"

↓  
8,5 mm  
↑

PAVIMENTO COORDINADO  
coordinated floor tile

■ STYL / 60,8X60,8 cm

IN &  
OUT

BLANCO    ARENA    PERLA    SILVER



PACKING & SPECIAL PIECES

	Pc/Cj	M2/Cj	Cj/PI	M2/PI	Kg/Cj	Kg/PI
25x70	9	1,58	64	101,12	24,64	1596,96
25x70 Riv	9	1,58	56	88,48	24,64	1399,84

	Cód.	
Miler	MR150	Riv Sook
		MR155

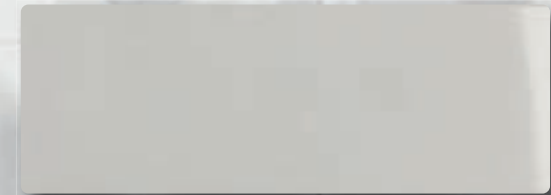

miler blanco



rlv sook arena

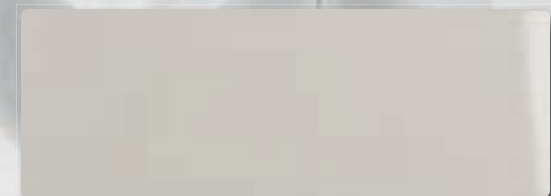

miler arena

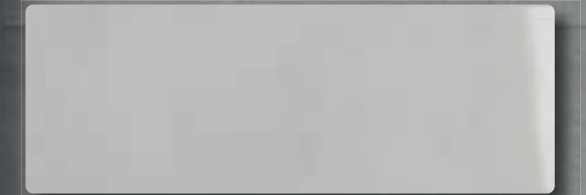

miler perla

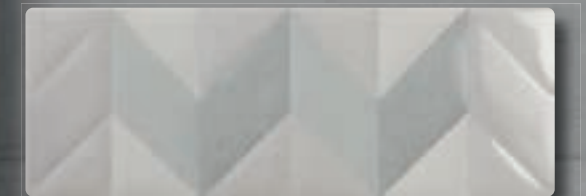

rlv sook perla

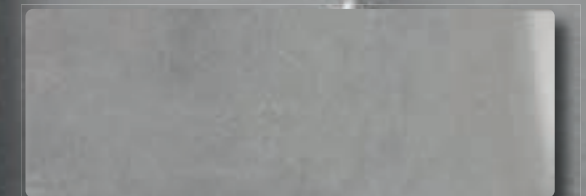

miler silver

Miler silver / Rlv Sook perla 25x70 / 10"x28"



# reness



RB



GRUPO  
BIII

25x70  
10"x28"

↓  
8,5 mm  
↑

### PIEZAS ESPECIALES special pieces

PAT

MOLDURA 3x25



P853

CENEFA 8x25



P851

ZÓCALO 15x25



P852

### PAVIMENTO COORDINADO coordinated floor tile

● RENESS / 60,8X60,8 cm

CREMA



GOLD

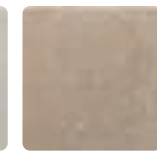

PERLA



GRIS

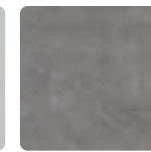

### PACKING & SPECIAL PIECES

	Pc/Cj	M2/Cj	Cj/PI	M2/PI	Kg/Cj	Kg/PI
25x70	9	1,58	64	101,12	24,64	1596,96
25x70 Riv	9	1,58	56	88,48	24,64	1399,84
	Cód.		Cód		Cód	
Reness	MR150	Riv Nitra	MR155	Dc Nest	MR156	

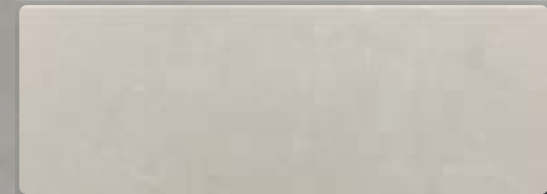

reness crema

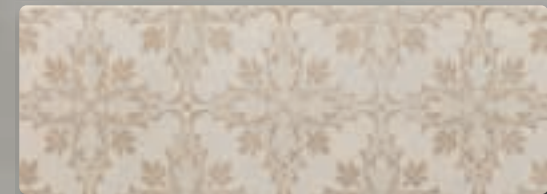

dc nest



riv nitra crema

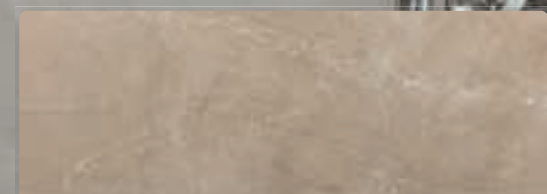

reness miel

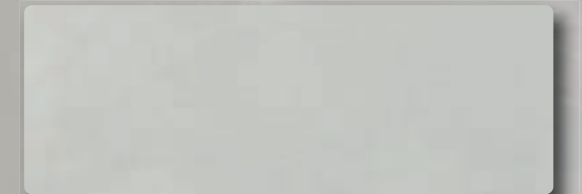

reness perla



dc nest perla



riv nitra perla

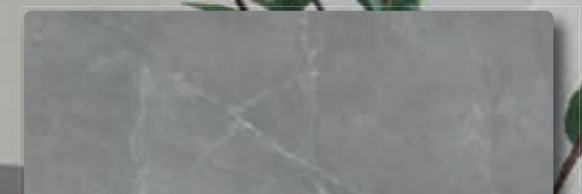

reness gris

Reness perla / Riv Nitra 25x70 / 10"x28"



# rodano



RB



GRUPO  
BIII

25x70  
10"x28"

↓  
8,5 mm  
↑

**PAVIMENTO COORDINADO**  
coordinated floor tile

■ **RODANO** / 60,8X60,8 cm

MARFIL    NATURAL    PERLA    GRIS

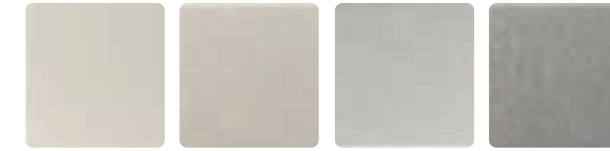

**PACKING & SPECIAL PIECES**

	Pc/Cj	M2/Cj	Cj/PI	M2/PI	Kg/Cj	Kg/PI
<b>25x70</b>	9	1,58	64	101,12	24,64	1596,96
<b>25x70 Riv</b>	9	1,58	56	88,48	24,64	1399,84

	Cód.	Cód	Cód
<b>Rodano</b>	MR150	<b>Riv Odra</b>	MR155
		<b>Dc Volga / Elba</b>	MR156



rodano marfil

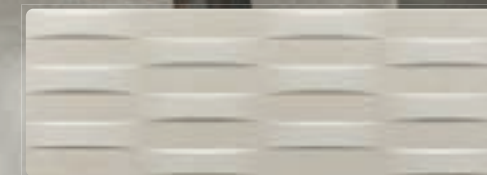

riv odra marfil



rodano natural



riv odra natural



dc volga marfil



rodano perla



riv odra perla

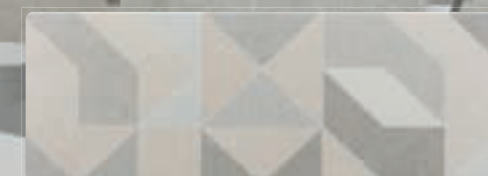

dc elba mix



rodano gris



riv odra gris

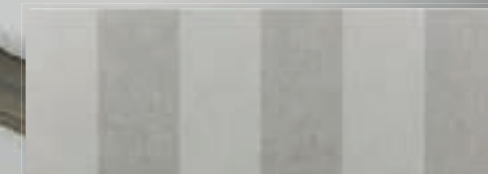

dc volga perla

**Rodano perla / Dc Volga perla 25x70 / 10"x28"**



# STUC



RB



GRUPO BIII

25x70  
10"x28"

↓  
8,5 mm  
↑

**PAVIMENTO COORDINADO**  
coordinated floor tile

■ **DYLON** / 60,8X60,8 cm



\* Diferentes diseños en una caja /  
Mixed designs in each box

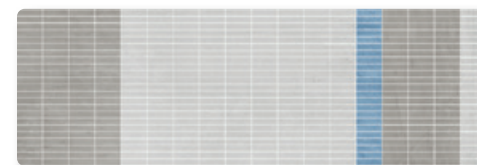

\*dc link perla

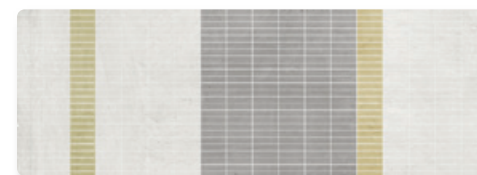

\*dc link marfil

**PACKING & SPECIAL PIECES**

	Pc/Cj	M2/Cj	Cj/PI	M2/PI	Kg/Cj	Kg/PI
<b>25x70</b>	9	1,58	64	101,12	24,64	1596,96
<b>25x70 Riv</b>	9	1,58	56	88,48	24,64	1399,84
	Cód.	Cód			Cód	
<b>Stuc</b>	MR150	<b>Rlv Flavia / Smart</b>	MR155	<b>Dc Link</b>	MR156	

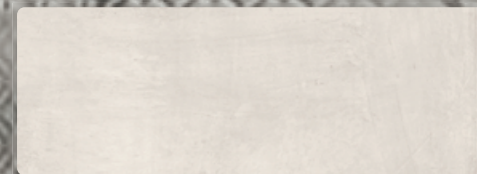

stuc marfil



rlv flavia marfil

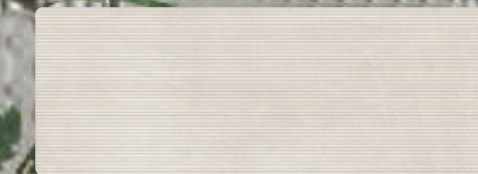

rlv smart marfil



stuc taupe



rlv flavia taupe

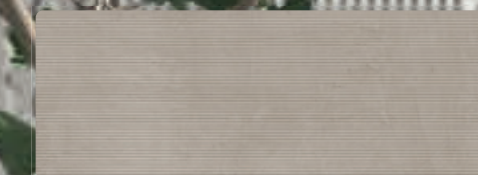

rlv smart taupe

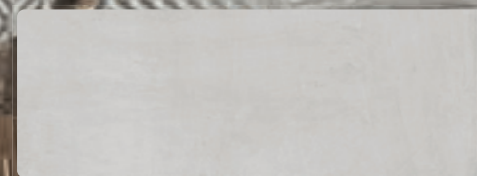

stuc perla



rlv flavia perla

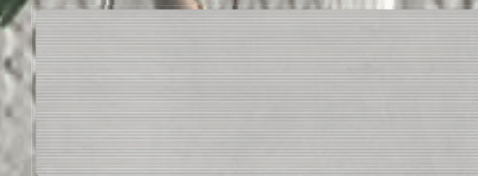

rlv smart perla



stuc gris



rlv flavia gris

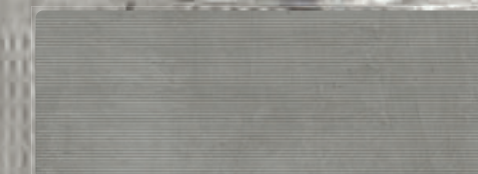

rlv smart gris

**Stuc perla / Rlv Flavia perla 25x70 / 10"x28"**



# murettos collection

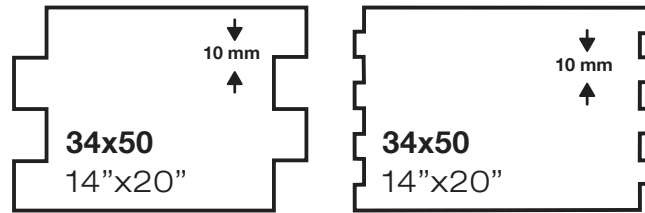

## PAVIMENTO RECOMENDADO recommended floor tile

### MILLENIUM / 20X120 cm



## PACKING & SPECIAL PIECES

	Pc/Cj	M2/Cj	Cj/PI	M2/PI	Kg/Cj	Kg/PI
<b>34x50</b>	9	1,5	48	72	25,2	1229,6
	<b>Cód.</b>					
<b>34x50</b>	MR122					



acid



zion



corwall óxido



bude blanco



bude antracita

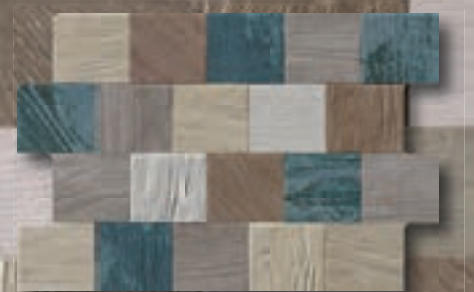

corwall mix



bude brown

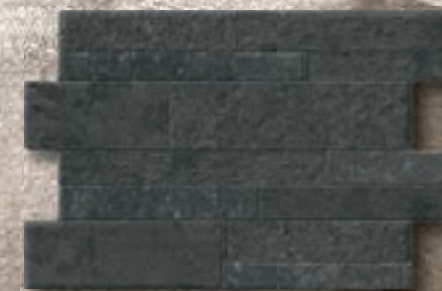

bude grafito



murogres natural

Corwall óxido 34x50 / 14"x20"



# bethel



RB



GRUPO BIII

30x90  
12"x36"

↓  
8,5 mm  
↑

### PAVIMENTO RECOMENDADO

recommended floor tile

■ TAIGA / 20X120 cm

CREMA

NOGAL

NOCE

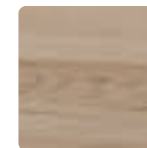

### PACKING & SPECIAL PIECES

	Pc/Cj	M2/Cj	Cj/PI	M2/PI	Kg/Cj	Kg/PI
<b>30x90</b>	7	1,9	48	91,2	30,5	1484
	Cód.		Cód.		Cód.	
<b>Bethel</b>	MR160	<b>Necker</b>	MR155	<b>Newhalen</b>	MR155	

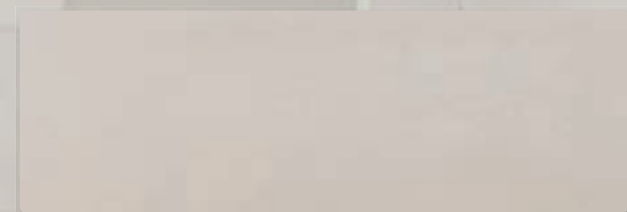

bethel marfil



necker ivory



newhalen crema

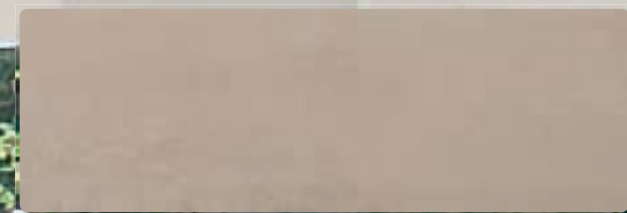

bethel moka



bethel gris



necker antracita



newhalen marengo

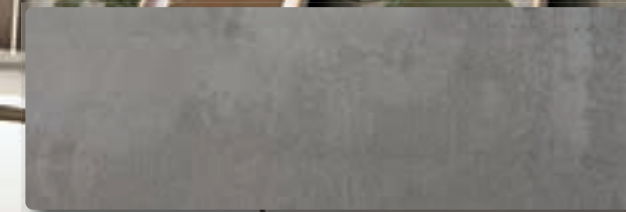

bethel marengo

Bethel marfil / Bethel moka / Necker ivory 30x90 / 12"x36"



# Flat



RB



30x90  
12"x36"

↓  
8,5 mm  
↑

## PACKING & SPECIAL PIECES

### PAVIMENTO RECOMENDADO recommended floor tile

■ **TIOGA / 20X60 cm**

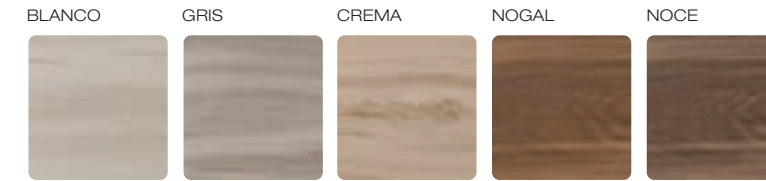

	Pc/Cj	M2/Cj	Cj/PI	M2/PI	Kg/Cj	Kg/PI
<b>30x90</b>	7	1,9	48	91,2	30,5	1484
	<b>Cód.</b>		<b>Cód.</b>		<b>Cód.</b>	
<b>Flat</b>	MR160	<b>Cerro</b>	MR155	<b>Lake</b>		MR155



flat blanco brillo

flat blanco mate

lake brillo

cerro brillo

Flat blanco / Lake brillo 30x90 / 12"x36"



graft



RB



GRUPO BIII

30x90  
12"x36"

↓  
10,5 mm  
↑

PAVIMENTO COORDINADO  
coordinated floor tile

■ GRAFT / 60,8X60,8 cm

CREMA

PERLA

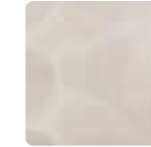

PACKING & SPECIAL PIECES

	Pc/Cj	M2/Cj	Cj/PI	M2/PI	Kg/Cj	Kg/PI
<b>30x90</b>	7	1,9	48	91,2	30,5	1484
	Cód.		Cód.		Cód.	
<b>Graft</b>	MR160	<b>Rlv Liceo</b>	MR165	<b>Dc Navona</b>	MR166	

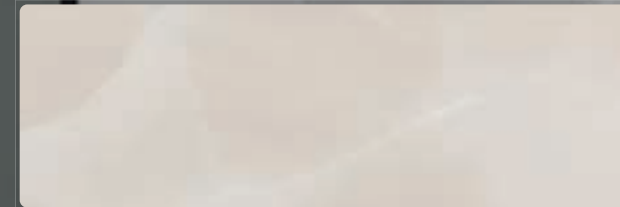

graft crema

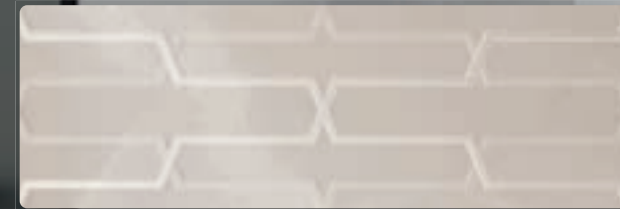

rlv liceo crema

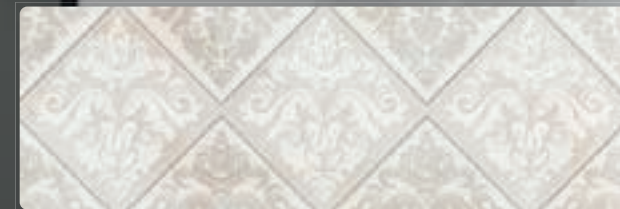

dc navona crema

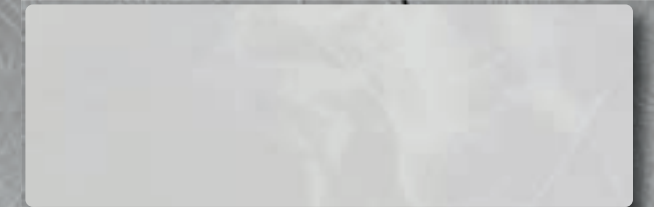

graft perla



rlv liceo perla



dc navona perla

Graft perla / Dc Navona perla 30x90 / 12"x36"



artan



RB



GRUPO  
BIII

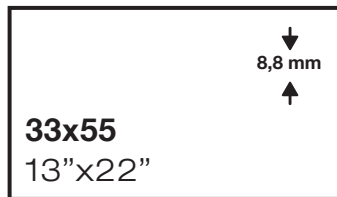

**PAVIMENTO RECOMENDADO**  
recommended floor tile

■ **TIOGA** / 20X60 cm

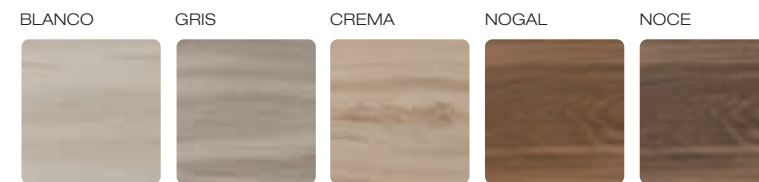

**PACKING & SPECIAL PIECES**

	Pc/Cj	M2/Cj	Cj/PI	M2/PI	Kg/Cj	Kg/PI
<b>33x55</b>	10	1,84	48	88,32	28	1364
<b>33x55 Rlv</b>	10	1,84	48	88,32	26,6	1296,8
	<b>Cód.</b>			<b>Cód.</b>		
<b>Artan</b>	MR100	<b>Rlv Klee / Track</b>	MR105			

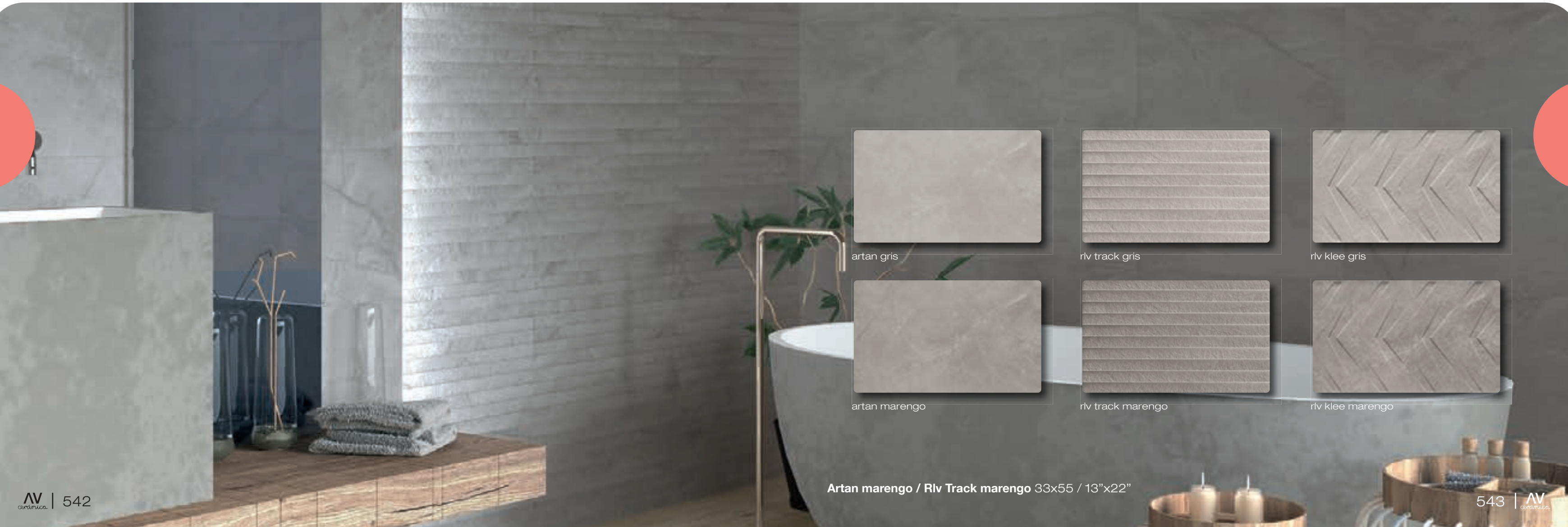

artan gris



rlv track gris

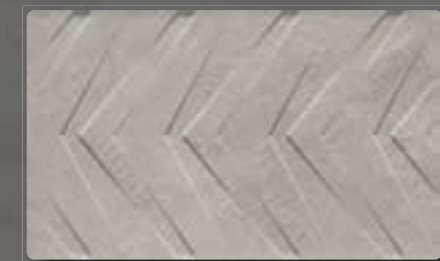

rlv klee gris

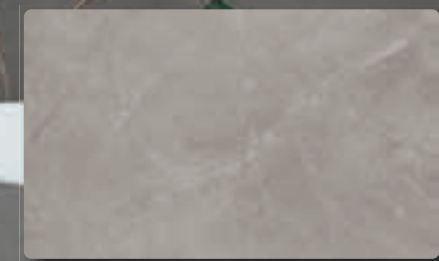

artan marengo



rlv track marengo

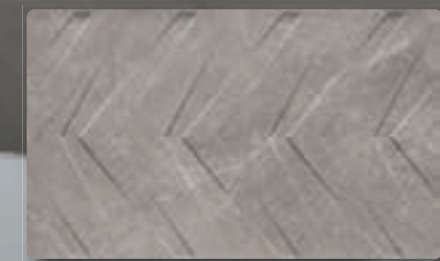

rlv klee marengo

Artan marengo / Rlv Track marengo 33x55 / 13"x22"



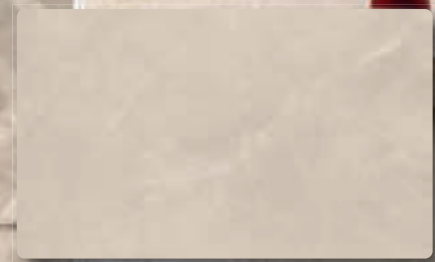

artan crema



rlv track crema



rlv klee crema

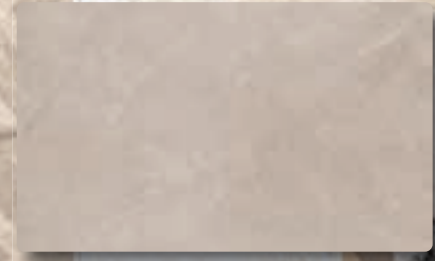

artan natural

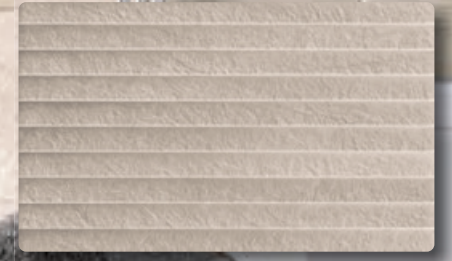

rlv track natural

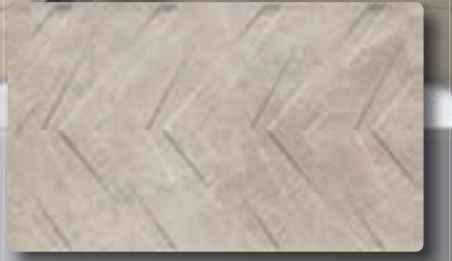

rlv klee natural

Artan crema / Rlv Klee crema 33x55 / 13"x22"



avart



RB



GRUPO  
BIII

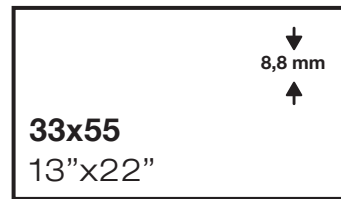

**PAVIMENTO COORDINADO**  
coordinated floor tile

■ **DRAVA** / 60,8X60,8 cm



**PACKING & SPECIAL PIECES**

	Pc/Cj	M2/Cj	Cj/PI	M2/PI	Kg/Cj	Kg/PI
<b>33x55</b>	10	1,84	48	88,32	28	1364
<b>33x55 Riv</b>	10	1,84	48	88,32	26,6	1296,8

	Cód.		Cód.		Cód.
<b>Avart</b>	MR100	<b>Rlv Avart</b>	MR105	<b>Dc Avart</b>	MR106

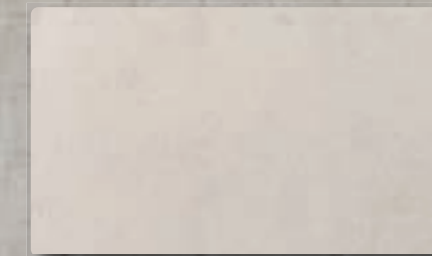

avart marfil



rlv avart marfil

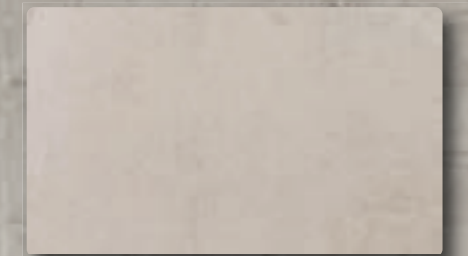

avart arena

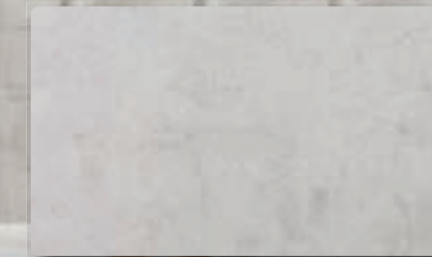

avart perla



rlv avart perla

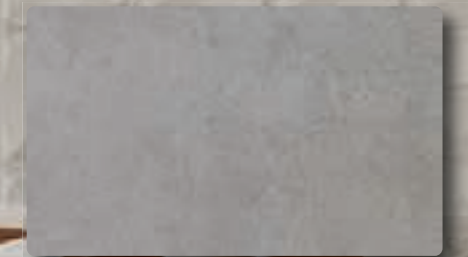

avart silver

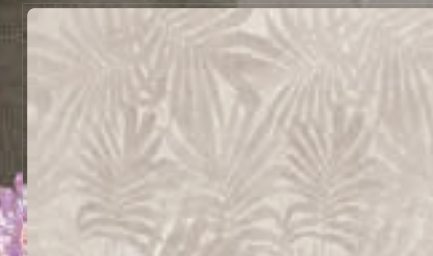

dc avart marfil

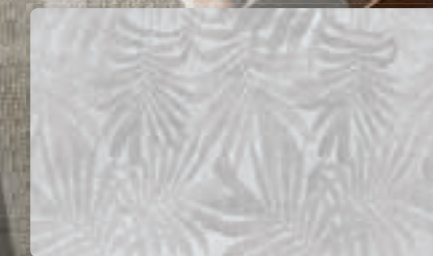

dc avart perla

Avart marfil / Rlv Avart marfil 33x55 / 13"x22"



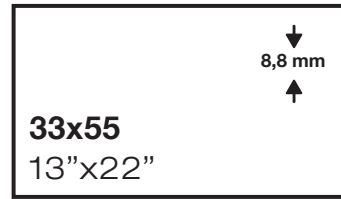

## PAVIMENTO RECOMENDADO recommended floor tile

■ **TIOGA** / 20X60 cm

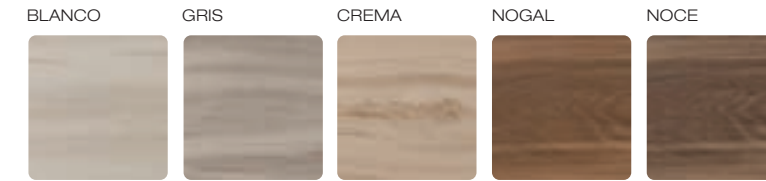

## PACKING & SPECIAL PIECES

	Pc/Cj	M2/Cj	Cj/PI	M2/PI	Kg/Cj	Kg/PI
<b>33x55</b>	10	1,84	48	88,32	28	1364
<b>33x55 Rlv</b>	10	1,84	48	88,32	26,6	1296,8
	<b>Cód.</b>					<b>Cód.</b>
<b>Calacatta</b>	MR100	<b>Rlv Linee / Calacatta</b>				MR105
		<b>Dc Calacatta</b>				MR106

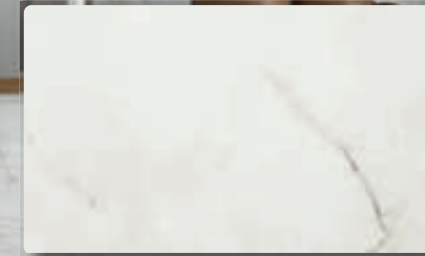

calacatta white matt



rlv linee white matt



dc calacatta white matt

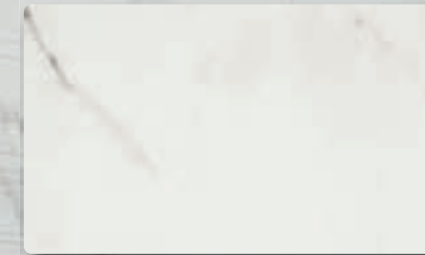

calacatta white gloss



rlv linee white gloss



rlv calacatta white gloss

**Calacatta white matt / Rlv Linee white matt 33x55 / 13"x22"**



# danos



RB

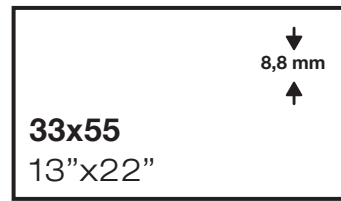

**PAVIMENTO COORDINADO**  
coordinated floor tile

■ **RODANO** / 60,8X60,8 cm

MARFIL      NATURAL      PERLA      GRIS



**PACKING & SPECIAL PIECES**

	Pc/Cj	M2/Cj	Cj/PI	M2/PI	Kg/Cj	Kg/PI
<b>33x55</b>	10	1,84	48	88,32	28	1364
<b>33x55 Rlv</b>	10	1,84	48	88,32	26,6	1296,8

	Cód.		Cód.		Cód.
<b>Danos</b>	MR100	<b>Rlv Danos</b>	MR105	<b>Dc Danos</b>	MR106



dc danos marfil

rlv danos marfil

danos marfil

rlv danos natural

danos natural

**Danos marfil / Rlv Danos marfil 33x55 / 13"x22"**





dc danos perla

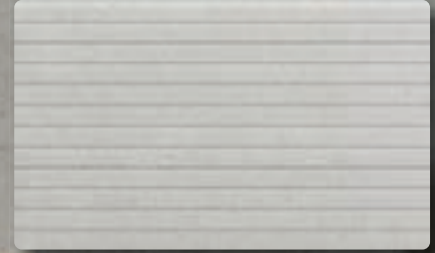

rlv danos perla

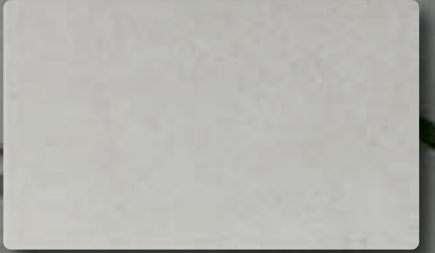

danos perla

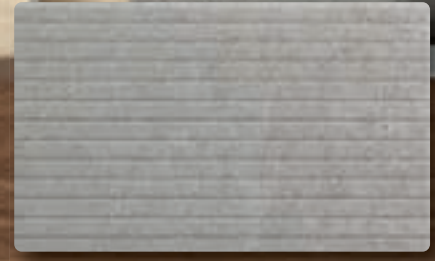

rlv danos gris



danos gris

Danos gris / Dc Danos perla 33x55 / 13"x22"



gualdo



RB

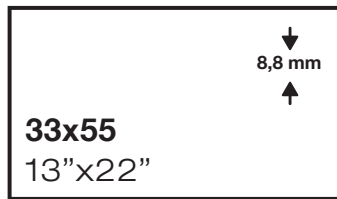

PACKING & SPECIAL PIECES

	Pc/Cj	M2/Cj	Cj/PI	M2/PI	Kg/Cj	Kg/PI
<b>33x55</b>	10	1,84	48	88,32	28	1364
<b>33x55 Riv</b>	10	1,84	48	88,32	26,6	1296,8
	Cód.			Cód.		
<b>Gualdo</b>	MR100	<b>Rlv Gualdo / Legua</b>		MR105		



gualdo white

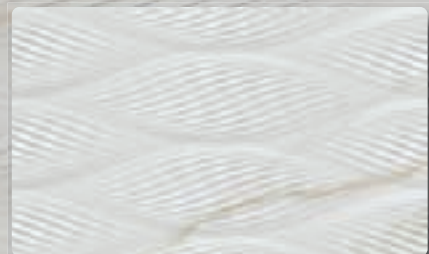

rlv gualdo white



rlv legua white matt

Rlv Gualdo-white 33x55 / 13"x22"



# lengo



RB

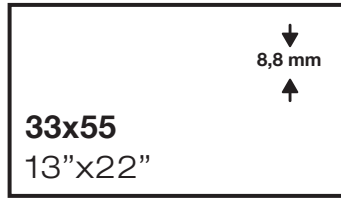

## PACKING & SPECIAL PIECES

	Pc/Cj	M2/Cj	Cj/PI	M2/PI	Kg/Cj	Kg/PI
33x55	10	1,84	48	88,32	28	1364
33x55 Riv	10	1,84	48	88,32	26,6	1296,8

	Cód.		Cód.		Cód.
Lengo	MR100	Rlv Lengo / Legua	MR105	Dc Lengo	MR106

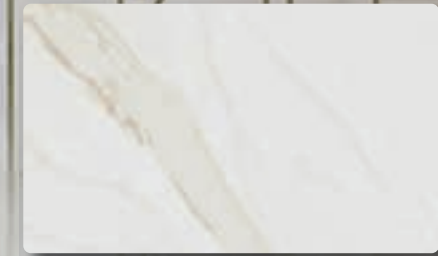

lengo white



rlv lengo white



dc lengo



rlv legua white gloss

Dc Lengo 33x55 / 13"x22"



north



RB



GRUPO BIII

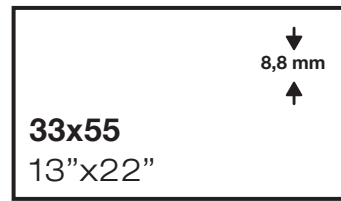

**PAVIMENTO RECOMENDADO**  
recommended floor tile

● **LUANY** / 60,8X60,8 cm

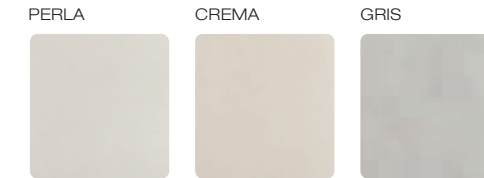

**PACKING & SPECIAL PIECES**

	Pc/Cj	M2/Cj	Cj/PI	M2/PI	Kg/Cj	Kg/PI
<b>33x55</b>	10	1,84	48	88,32	28	1364
<b>33x55 Riv</b>	10	1,84	48	88,32	26,6	1296,8
	Cód.		Cód.		Cód.	
<b>North</b>	MR100	<b>Rlv North</b>	MR105	<b>Dc North</b>	MR106	



dc north marfil



north marfil



rlv north mix



dc north marengo

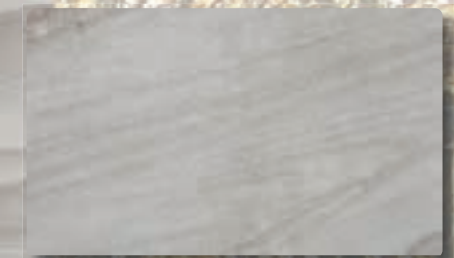

north perla

North perla / Dc North perla 33x55 / 13"x22"



pisa



RB

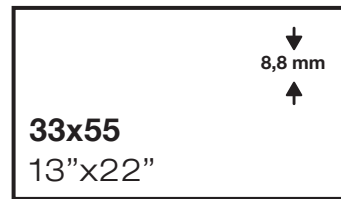

**PAVIMENTO RECOMENDADO**  
recommended floor tile

■ FUSTA / 20X60 cm



**PACKING & SPECIAL PIECES**

	Pc/Cj	M2/Cj	Cj/PI	M2/PI	Kg/Cj	Kg/PI
<b>33x55</b>	10	1,84	48	88,32	28	1364
<b>33x55 Rlv</b>	10	1,84	48	88,32	26,6	1296,8
	<b>Cód.</b>		<b>Cód.</b>			
<b>Pisa</b>	MR100	<b>Rlv Pisa</b>	MR105			



Pisa gris / Pisa antracita / Rlv Pisa gris 33x55 / 13"x22"  
Fusta marengo 20x60 / 8"x24"



# sener



RB



GRUPO  
BIII

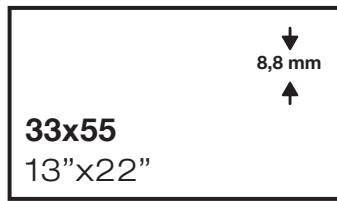

**PAVIMENTO COORDINADO**  
coordinated floor tile

● **RENESS / 60,8X60,8 cm**



**PACKING & SPECIAL PIECES**

	Pc/Cj	M2/Cj	Cj/PI	M2/PI	Kg/Cj	Kg/PI
<b>33x55</b>	10	1,84	48	88,32	28	1364
<b>33x55 Rlv</b>	10	1,84	48	88,32	26,6	1296,8
	Cód.		Cód.		Cód.	
<b>Sener</b>	MR100	<b>Rlv Sener</b>	MR105	<b>Dc Sener</b>	MR106	

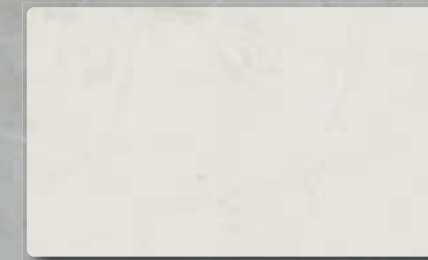

sener crema



rlv sener crema

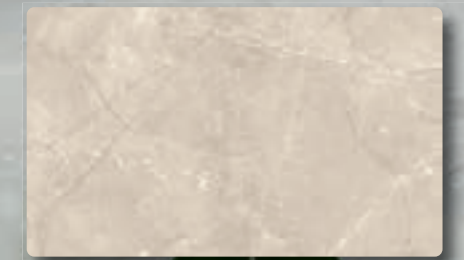

sener gold

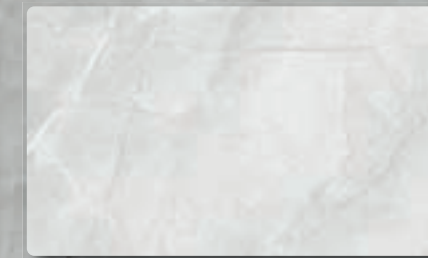

sener perla



rlv sener perla



sener gris



dc sener crema



dc sener gris

**Sener perla / Rlv Sener perla 33x55 / 13"x22"**





## PACKING & SPECIAL PIECES

	Pc/Cj	M2/Cj	Cj/PI	M2/PI	Kg/Cj	Kg/PI
<b>25x50</b>	16	2	48	96	26,5	1292
<b>20x60</b>	9	1,08	80	86,4	17,9	1452
<b>25x70</b>	9	1,58	64	101,12	24,64	1596,9
<b>30x60</b>	8	1,44	256	46,08	22,5	740
<b>30x90</b>	7	1,9	48	91,2	30,5	1484

### PASTA ROJA / RED BODY

	Cód.
Fresh mate 25x50	MR110
Fresh White / Mate 31x31	MG100
Next White / Mate 20x60	MR140
Flat Blanco / Mate 25x70	MR150
Flat Brillo / Mate 30x90	MR160
Blanco Brillo / Mate 31,6x60	MR130
Blanco Brillo / Mate 33,3x55	MR100

	Pc/Cj	M2/Cj	Cj/PI	M2/PI	Kg/Cj	Kg/PI
<b>36x80</b>	4	1,15	54	62,1	18,5	1019
<b>31,6X60</b>	8	1,52	48	72,96	26	1268
<b>33,3X55</b>	10	1,84	48	88,32	28	1364
<b>33X100</b>	6	2	48	96	24	1172

### PASTA BLANCA / WHITE BODY

	Cód.
Franee Blanco Brillo 25x50	MB110
Annie / Timisoara 30x90	MB140
Blanco Brillo / Mate 30x60	MB130
Sandra Mate 36x80	MB120
Terranova Brillo 36x80	MB120
Daffen / Ethan 33,3x100	MB150

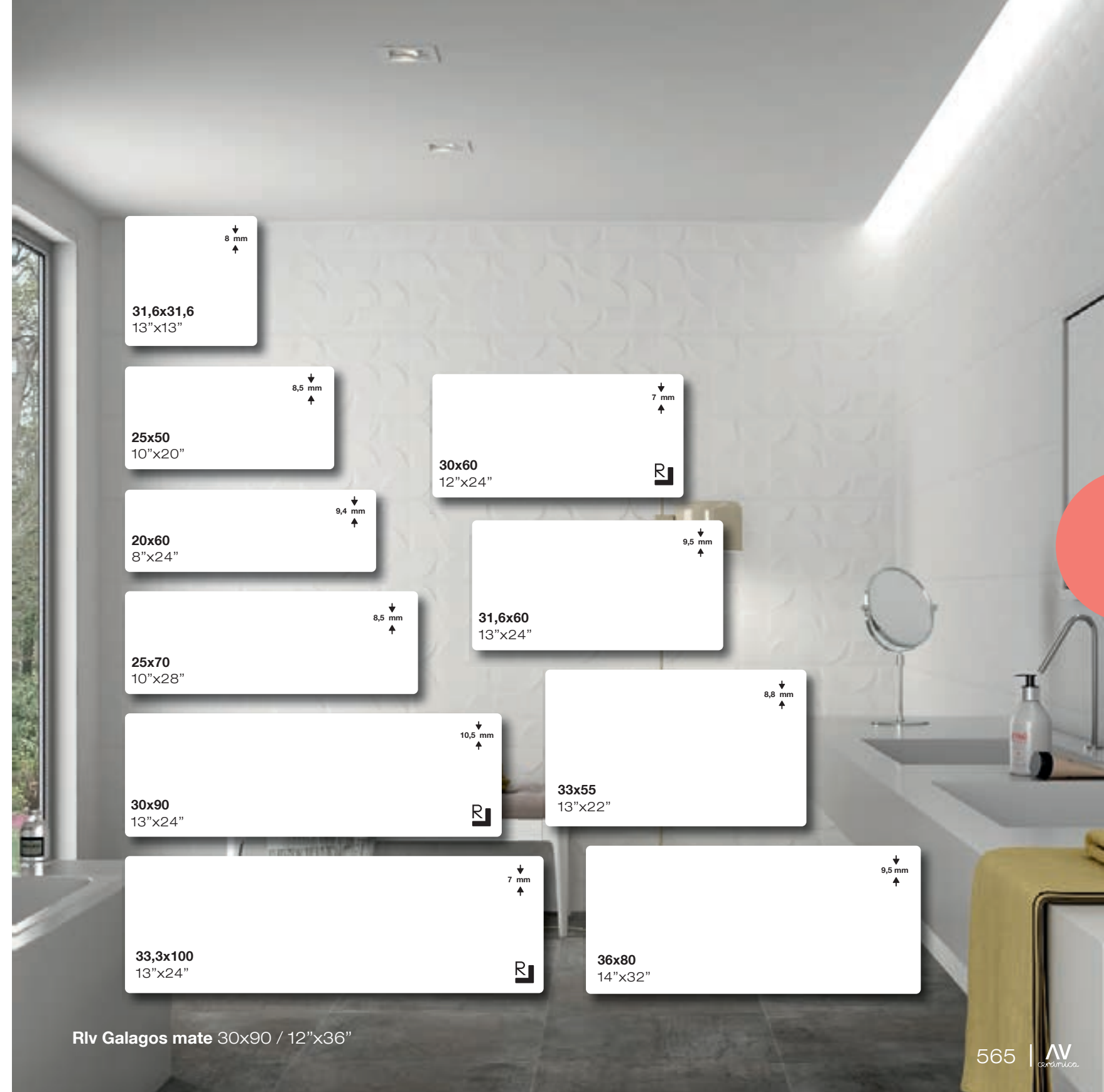

↓ 8 mm  
↑  
**31,6x31,6**  
13"x13"

↓ 8,5 mm  
↑  
**25x50**  
10"x20"

↓ 7 mm  
↑  
**30x60**  
12"x24"

↓ 9,4 mm  
↑  
**20x60**  
8"x24"

↓ 9,5 mm  
↑  
**31,6x60**  
13"x24"

↓ 8,5 mm  
↑  
**25x70**  
10"x28"

↓ 8,8 mm  
↑  
**33x55**  
13"x22"

↓ 10,5 mm  
↑  
**30x90**  
13"x24"

↓ 7 mm  
↑  
**33,3x100**  
13"x24"

↓ 9,5 mm  
↑  
**36x80**  
14"x32"

Rlv Galagos mate 30x90 / 12"x36"





ÁREA TÉCNICA  
TECHNICAL AREA  
DOMAINE TECHNIQUE  
TECHNISCHER BEREICH



Soluciones técnicas  
**Technical Solutions**

La adherencia entre la pieza y el soporte junto con una buena colocación juegan un papel imprescindible en la vida útil de la cerámica. El avance de las tecnologías ha dado lugar a una nueva era debido a la mejora en las propiedades de la cerámica, tales como la disminución de la porosidad, la alta resistencia a la abrasión y al hielo y la creación de grandes formatos y acabados de ensueño.

Dicha evolución cerámica da lugar al avance de los adhesivos, pasando de una adherencia mecánica, en el que se necesita una gruesa capa de material, frente a la adherencia química actual, la cual, a parte de reducir la cantidad de material a utilizar, mejora la adherencia y por consiguiente su durabilidad.

Algunas recomendaciones para garantizar la correcta colocación de la baldosa cerámica son utilizar herramientas y útiles adecuados, tales como llana dentada, maza de goma blanca, nivel de burbuja y ventosa. La instalación será siempre con doble encolado, junta mínima de 2 mm, excepto espesados, que dejaremos una junta mínima de 5 mm. No utilizaremos productos que contengan negro de humo o carbón micronizado. Como también, una buena limpieza del soporte para eliminar cualquier resto de yeso o pintura, utilizando siempre limpiadores finalizadores de obra, que no contengan ácido fluorhídrico. A parte de considerar siempre las indicaciones del fabricante.

The adhesion between the piece and the support together with a good placement play an essential role in the useful life of the ceramic. The advancement of technologies has given rise to a new era due to the improvement in the properties of ceramics, such as reduced porosity, high resistance to abrasion and ice and the creation of large formats and dream finishes. .

This ceramic evolution gives rise to the advancement of adhesives, moving from a mechanical adherence, in which a thick layer of material is needed, compared to current chemical adherence, which, apart from reducing the amount of material to be used, improves adherence and consequently its durability.

Some recommendations to guarantee the correct placement of the ceramic tile are to use suitable tools and tools, such as notched trowel, white rubber mallet, spirit level and suction cup. As well as a good cleaning of the support to remove any remaining plaster, painting etc. Apart from always considering the manufacturer's indications.

recomendaciones de colocación y limpieza  
**Placement and cleaning recommendations**

grandes formatos  
big sizes



formato 33x100  
33x100 size



limpieza  
cleaning



certificación  
**Certification**

Nuestra constante inquietud por avanzar y satisfacer las necesidades más exigentes del mercado, nos permite tener un producto cerámico de calidad con un diseño de última tendencia. Este compromiso se ha visto reconocido por los distintos certificados de calidad. Alcanzamos con creces los requisitos que nos convierten en una empresa certificada ISO 9001:2015 en el diseño, producción y distribución de nuestras colecciones cerámicas. Disponemos de un sistema productivo basado en la calidad de nuestros productos y la confianza de nuestros clientes.

Our constant concern to advance and satisfy the most demanding needs of the market, allows us to have a quality ceramic product with a cutting-edge design. This commitment has been recognized by the various quality certificates. We more than reach the requirements that make us an ISO 9001: 2015 certified company in the design, production and distribution of our ceramic collections. We have a production system based on the quality of our products and the trust of our customers.



Descarga nuestros certificados aquí.



ISO 14021:2016





modelos upec

**UPEC series**

El sello UPEC es un certificado francés expedido por el Centre Scientifique du Bâtiment (CSTB), el cual garantiza la seguridad y calidad de los productos cerámicos de Navarti conforme a unas especificaciones técnicas concretas. Para la obtención de este sello, clasificado dentro del certificado NF, los materiales de Navarti han sido sometidos a unos rigurosos controles de calidad. Cada sigla de la palabra UPEC hace referencia a un rasgo específico del material:

- U** - resistencia al desgaste
- P** - resistencia a la perforación o rotura
- E** - resistencia a la humedad y al agua
- C** - resistencia a los agentes químicos



The UPEC seal is a French certificate issued by the Centre Scientifique du Bâtiment (CSTB), which guarantees the safety and quality of Navarti ceramic products according to specific technical specifications. To obtain this seal, classified within the NF certificate, Navarti materials have been subjected to rigorous quality controls. Each acronym of the word UPEC refers to a specific feature of the material:

- U - wear resistance
- P - resistance to puncture or breakage
- E - resistance to moisture and water
- C - resistance to chemical agents

**SERIE ANTIBES / ANTIBES SERIES**

FORMATO	ESPEJOR	PECULIARIDAD	COLORES	CLASIFICACIÓN
45X45	9,5 mm	-	dark grey	U4 P4 E3 C2
45X45	9,5 mm	-	grey	U4 P4 E3 C2
45X45	9,5 mm	-	ivory	U4 P4 E3 C2
45X45	9,5 mm	-	pearl	U4 P4 E3 C2
60X60	9,5 mm	rectificado	dark grey	U4 P3 E3 C2
60X60	9,5 mm	rectificado	grey	U4 P3 E3 C2
60X60	9,5 mm	rectificado	ivory	U4 P3 E3 C2
60X60	9,5 mm	rectificado	pearl	U4 P3 E3 C2

**SERIE ZIRO / ZIRO SERIES**

FORMATO	ESPEJOR	PECULIARIDAD	COLORES	CLASIFICACIÓN
45X45	9,5 mm	-	blanco	U4 P4 E3 C2
45X45	9,5 mm	-	crema	U4 P4 E3 C2
45X45	9,5 mm	-	gris	U4 P4 E3 C2
45X45	9,5 mm	-	marengo	U4 P4 E3 C2
45X45	9,5 mm	-	perla	U4 P4 E3 C2
60X60	9,5 mm	rectificado	blanco	U4 P3 E3 C2
60X60	9,5 mm	rectificado	crema	U4 P3 E3 C2
60X60	9,5 mm	rectificado	gris	U4 P3 E3 C2
60X60	9,5 mm	rectificado	marengo	U4 P3 E3 C2
60x60	9,5 mm	rectificado	perla	U4 P3 E3 C2

**SERIE SOUTHROCK / SOUTHROCK SERIES**

FORMATO	ESPEJOR	PECULIARIDAD	COLORES	CLASIFICACIÓN
45X45	9,5 mm	-	gris	U2S P3 E3 C2
45X45	9,5 mm	-	marengo	U2 P3 E3 C2
45X45	9,5 mm	-	perla	U3 P3 E3 C2

**SERIE BERLÍN / BERLIN SERIES**

FORMATO	ESPEJOR	PECULIARIDAD	COLORES	CLASIFICACIÓN
45X45	9,5 mm	-	gris	U2S P3 E3 C2
45X45	9,5 mm	-	perla	U2S P3 E3 C2
60,8x60,8	9,5 mm	-	gris	U2S P3 E3 C2
60,8x60,8	9,5 mm	-	perla	U2S P3 E3 C2

modelos in & out

**IN & OUT series**

SERIE	FORMATO	ESPEJOR	NAT	COLORES	PÁG.
MUTAZ	30,3X61,3	9 mm	CLASE 3	blanco / crema / gris / marengo	412
SANDER	30,3X61,3	9 mm	CLASE 3	blanco / marfil / perla / silver	420
RLV MUST (SANDER)	30,3X61,3	9 mm	CLASE 3	blanco / marfil / perla / silver	420
STYL	30,3X61,3	9 mm	CLASE 3	blanco / arena / perla / silver	426
RLV ELYT (STYL )	30,3X61,3	9 mm	CLASE 3	blanco / arena / perla / silver	426
TOWNS	30,3X61,3	9 mm	CLASE 3	white / taupe / pearl / gris	430
RLV NIMES (TOWNS)	30,3X61,3	9 mm	CLASE 3	white / taupe / pearl / gris	430

SERIE	FORMATO	ESPEJOR	NAT	COLORES	PÁG.
TILOS	20X120	9 mm	CLASE 3	blanco / arce / natural / ébano	466

SERIE	FORMATO	ESPEJOR	NAT	COLORES	PÁG.
AMYR	60,8X60,8	9,5 mm	CLASE 3	ivory / musgo / antracita	380
MUTAZ	60,8X60,8	9,5 mm	CLASE 3	blanco / crema / gris / marengo	412
PORTO	60,8X60,8	9,5 mm	CLASE 3	gris/ magma / tierra	394
SANDER	60,8X60,8	9,5 mm	CLASE 3	blanco / marfil / perla / silver	420
STYL	60,8X60,8	9,5 mm	CLASE 3	blanco / arena / perla / silver	426
TOWNS	60,8X60,8	9,5 mm	CLASE 3	white / taupe / pearl / gris	430



SANDER BLANCO 60,8x60,8 / 24"x24"



		33,3x100cm / 13"x24"	60x60 / 24"x24"	30x90cm / 11,8"x35,4"	36x80cm / 14"x31,2"	25x70cm / 9,8"x27,5"	30x60cm / 11,8"x23,6"	20x60cm / 7,9"x23,6"	33x55cm / 13"x21,6"	25x50cm / 9,8"x19,7"	20x30 / 8"x12"	20x20 / 8"x8"
Ágora	Dc Ágora											
	Dc Ágora Vent.											502
Algher	Rlv Algher					516						
	Rlv Galagos											
Annie	Rlv Oradea		316									
	Rlv Arad											
Artan	Rlv Track											542
	Rlv Klee											
Aruma	Rlv Aruma		318									
	Rlv Marmi											
Avart	Rlv Avart											546
	Dc Avart											
Azur	Dc Azur											504
	Dc Azur Vent.											
Belgravia	Line											115 115
	Tex											
Bellagio	Rlv Bellagio		320									
	Bellagio Waves											
Bergen	Rlv Flam											494
	Rlv Levita											
Bethel	Necker											536
	Newhalen											
Byron	Dc Howe											496
Calacatta	Rlv Calacatta											
	Rlv Linee											548
	Dc Calacatta											
Calcare	Rlv Boa											
	Rlv Enzo		320									
	Dc Edith											
	Dc Kovo											
Carra	Rlv Carra		326									
Ceres	Rlv Hoyo		328									
Daffen	Rlv Ted	356										
	Rlv Hanne											
Dafne	Rlv Ladon											
	Dc Omeya											506
	Dc Tierra											
Danos	Rlv Danos											550
	Dc Danos											

Technical Porcelain  
Porcelánico Masa Coloreada

		33,3x100cm / 13"x24"	60x60 / 24"x24"	30x90cm / 11,8"x35,4"	36x80cm / 14"x31,2"	25x70cm / 9,8"x27,5"	30x60cm / 11,8"x23,6"	20x60cm / 7,9"x23,6"	33x55cm / 13"x21,6"	25x50cm / 9,8"x19,7"	20x30 / 8"x12"	20x20 / 8"x8"
Drava	Rlv Upa											
	Rlv Don											
	Dc Mologa			330								
Ethan	Dc Saale											
	Rlv Ted											358
	Rlv Hanne											
Flat	Ondas											518
	Liner											
	Lake											539
	Cerro											
Giro	Rlv Rhom											498
	Rlv Lido											
Graft	Rlv Liceo											540
	Dc Navona											
Gualdo	Rlv Gualdo											554
	Rlv Legua											
Inka	Rlv Tahoe		63									63
	Dc Jersey											
Iris	Dc Iris											
	Dc Canvas											334
	Rlv Myra											
Kairos	Rlv Icon											
	Rlv Cronos											520
Kamen	Rlv Name											360
	Rlv Bilice											
	Dc Lovret											
Keon	Rlv Natu											500
	Rlv Keon											
Laos	Rlv Luang										522	
Lengo	Rlv Lengo											556
	Rlv Legua											
	Dc Lengo											
Lithos	Rlv Tye											338
	Dc Lithos											
Londra	Rlv Croy											510
	Dc Londra											
Manhattan	Rlv Manhattan											342
Memphis	Dc Dim											524
Merlino	Rlv Merlino											344

White Body Wall Tile  
Pasta Blanca

		33,3x100cm / 13"x24"	60x60 / 24"x24"	30x90cm / 11,8"x35,4"	36x80cm / 14"x31,2"	25x70cm / 9,8"x27,5"	30x60cm / 11,8"x23,6"	20x60cm / 7,9"x23,6"	33x55cm / 13"x21,6"	25x50cm / 9,8"x19,7"	20x30 / 8"x12"	20x20 / 8"x8"	30,3x61,3 / 12"/24"
Miier	Rlv Sook												526
	Rlv Nature												346
North	Rlv North Mix												558
Pisa	Rlv Pisa												528
Reness	Dc Nest												348
	Rlv Nitra												
Rochee	Rlv Rochee												348
Rodano	Rlv Odra												530
	Dc Volga												
Royal	Dc Elba												
	Rlv Lineroyal												350
Sander	Rlv Georoyal												
	Rlv Must												420
Sandra	Rlv Sandra												310
	Rlv Noon												
Sener	Rlv Sener												562
	Dc Sener												
Serene	Rlv Serene											352	
Sonora	Rlv Sonora												514
Stuc	Rlv Flavia												532
	Rlv Smart												
	Dc Link												
Styl	Rlv Elyt												426
Terranova	Rlv Terranova												308
	Rlv Indoc												
Timisoara	Rlv Galagos												354
	Rlv Kross												
Towns	Rlv Nimes												426
Ziro	Dc Bree												312
	Dc Ergo												

20mm Thicknes  
Espesorado 20mm

Red Body Wall Tile  
Revestimiento Pasta Roja

RLV CERES ÓXIDO 30x90 / 12"x36"

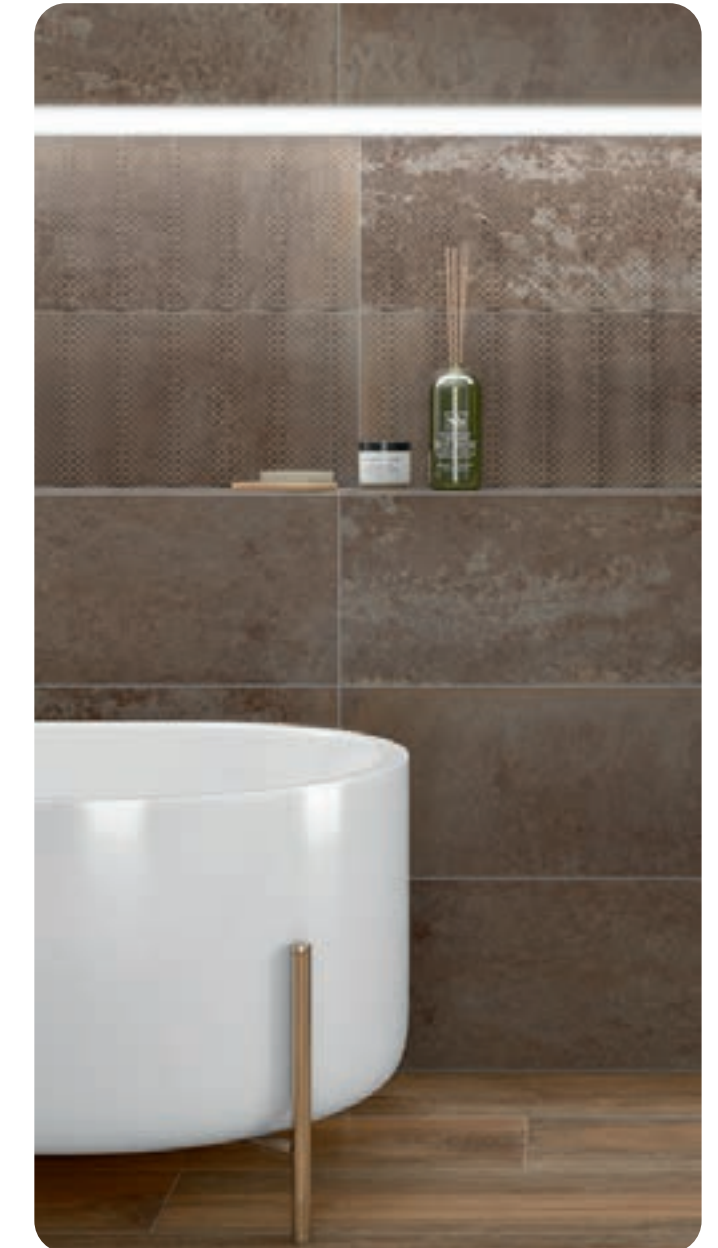

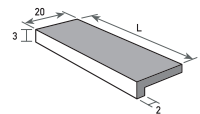
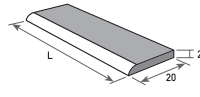
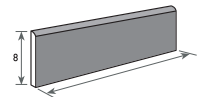
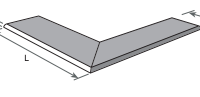
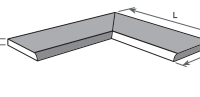
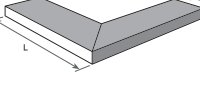
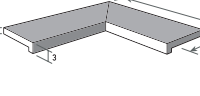
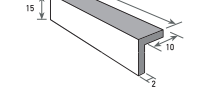
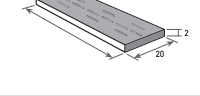
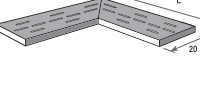

piezas especiales 20mm • 20mm special pieces

Producto - Formato	76x76	61x61
BORDE ING INGLETADO		20x76 20x61
BORDE RE CANTO ROMO		20x76 20x61
RODAPIE RE		8x76 8x61
BORDE ÁNGULO EXTERIOR RE		20x76 20x61
BORDE ÁNGULO INTERIOR RE		20x76 20x61
BORDE ÁNGULO EXTERIOR ING		20x76 20x61
BORDE ÁNGULO INTERIOR ING		20x76 20x61
PELDAÑO INGLETADO FRONTAL		10x15x76 10x15x6
REJILLA		20x76 20x61
REJILLA ÁNGULO		20x76 20x61

Producto - Formato	76x76	61x61
FOCO		76x76 61x61
PELDAÑO RE CANTO ROMO		76x76 61x61
PELDAÑO ÁNGULO RE CANTO ROMO		76x76 61x61
PELDAÑO ING INGLETADO		76x76 61x61
PELDAÑO ÁNGULO ING INGLETADO		76x76 61x61
CANTO PELDAÑO ROMO DOBLE ROMO		30x76 30x61



REJILLA ÁNGULO GRAIN STONE SILVER / GRAIN STONE SILVER ANGLE RACK

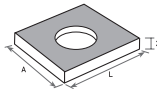
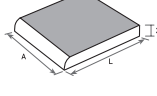
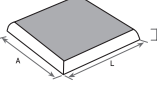
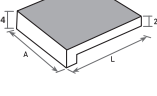
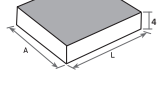

Producto - Formato	20x20	20x30
RODAPIE RE 	20x20	20x30
BORDE ÁNGULO EXTERIOR RE 	20x20	20x30
BORDE ÁNGULO INTERIOR RE 	20x20	20x30
BORDE ÁNGULO EXTERIOR ING 	20x20	20x30
BORDE ÁNGULO INTERIOR ING 	20x20	20x30
PELDAÑO INGLETADO FRONTAL 	20x20x2	20x30x2
REJILLA 	20x20	20x30
REJILLA ÁNGULO 	20x20	20x30

Producto - Formato	20x20	20x30
FOCO 	20x20	20x30
PELDAÑO RE CANTO ROMO 	20x20	20x30
PELDAÑO ÁNGULO RE CANTO ROMO 	20x20	20x30
PELDAÑO ING INGLETADO 	20x20	20x30
PELDAÑO ÁNGULO ING INGLETADO 	20x20	20x30

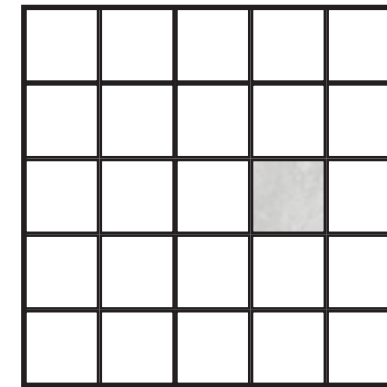

1m<sup>2</sup> 20x30 - 0% m<sup>2</sup>  
20x20 - 100% m<sup>2</sup>

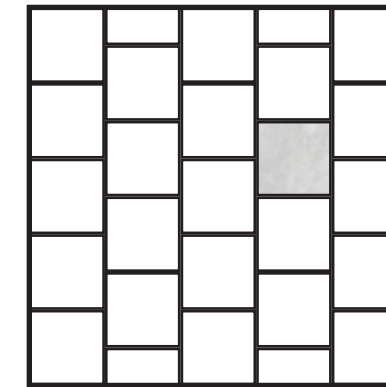

1m<sup>2</sup> 20x30 - 0% m<sup>2</sup>  
20x20 - 100% m<sup>2</sup>

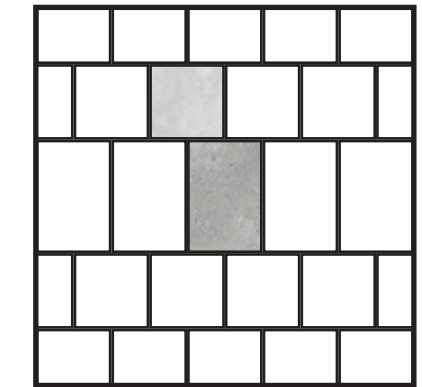

1m<sup>2</sup> 20x30 - 72,7% m<sup>2</sup>  
20x20 - 27,3% m<sup>2</sup>

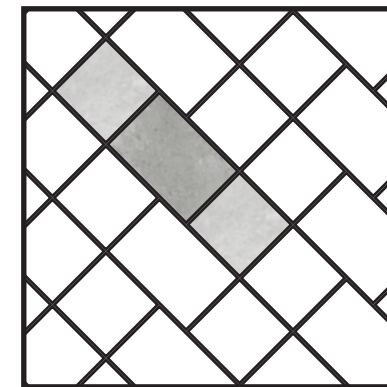

1m<sup>2</sup> 20x30 - 44,7% m<sup>2</sup>  
20x20 - 55,3% m<sup>2</sup>

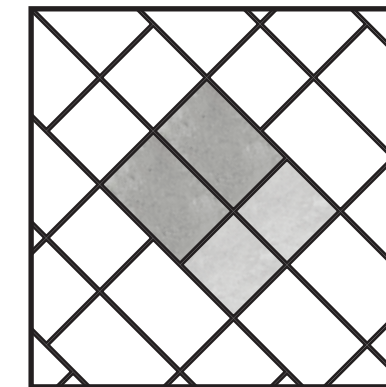

1m<sup>2</sup> 20x30 - 63,8% m<sup>2</sup>  
20x20 - 36,2% m<sup>2</sup>

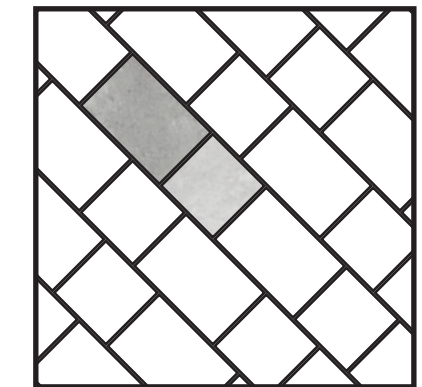

1m<sup>2</sup> 20x30 - 62,8% m<sup>2</sup>  
20x20 - 37,2% m<sup>2</sup>

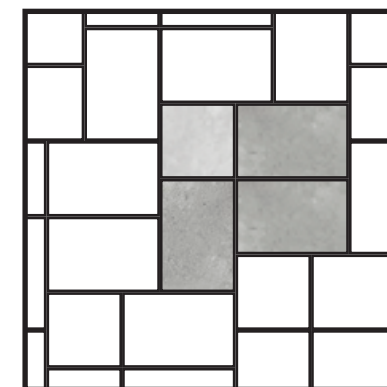

1m<sup>2</sup> 20x30 - 77,8% m<sup>2</sup>  
20x20 - 22,2% m<sup>2</sup>

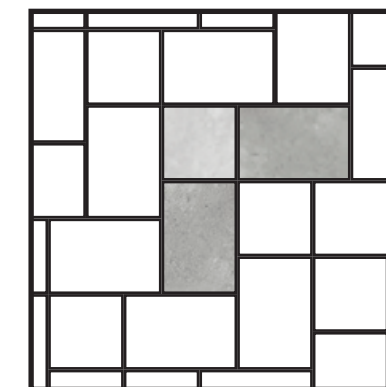

1m<sup>2</sup> 20x30 - 72,7% m<sup>2</sup>  
20x20 - 27,3% m<sup>2</sup>

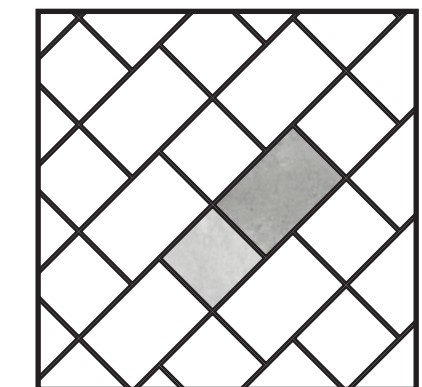

1m<sup>2</sup> 20x30 - 64,7% m<sup>2</sup>  
20x20 - 35,3% m<sup>2</sup>



esquemas de colocación • laying schemes

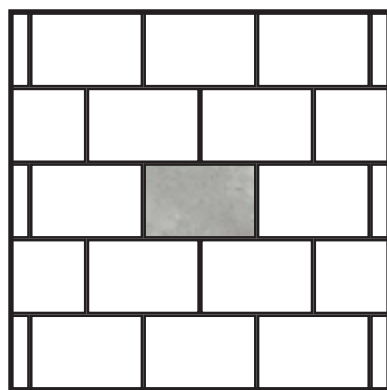

1m<sup>2</sup> 20x30 - 100% m<sup>2</sup>  
20x20 - 0% m<sup>2</sup>

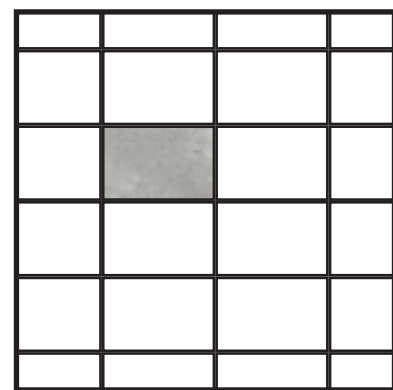

1m<sup>2</sup> 20x30 - 100% m<sup>2</sup>  
20x20 - 0% m<sup>2</sup>

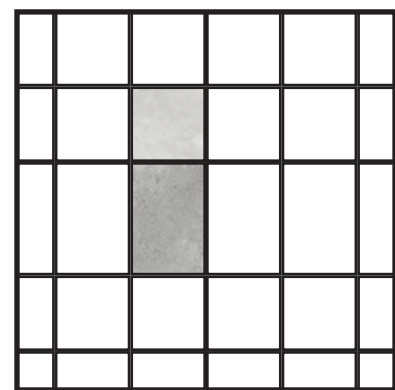

1m<sup>2</sup> 20x30 - 60% m<sup>2</sup>  
20x20 - 40% m<sup>2</sup>

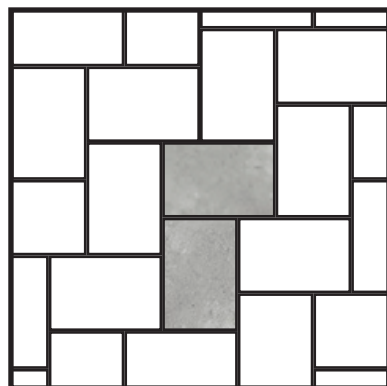

1m<sup>2</sup> 20x30 - 100% m<sup>2</sup>  
20x20 - 0% m<sup>2</sup>

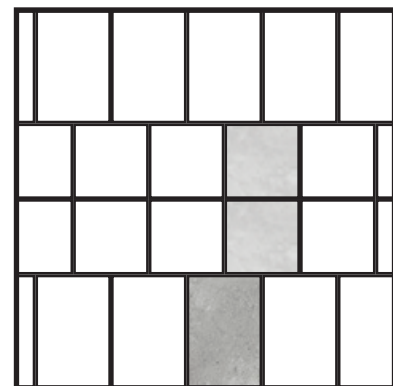

1m<sup>2</sup> 20x30 - 55,1% m<sup>2</sup>  
20x20 - 44,9% m<sup>2</sup>

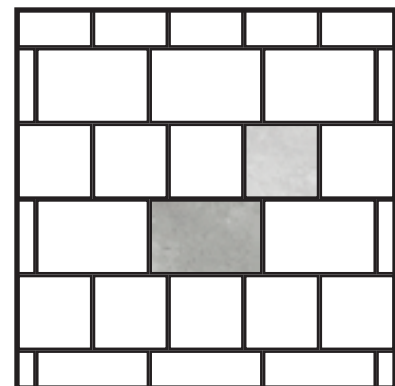

1m<sup>2</sup> 20x30 - 64,7% m<sup>2</sup>  
20x20 - 35,3% m<sup>2</sup>

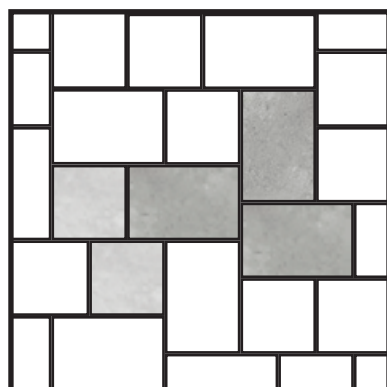

1m<sup>2</sup> 20x30 - 70,1% m<sup>2</sup>  
20x20 - 29,9% m<sup>2</sup>

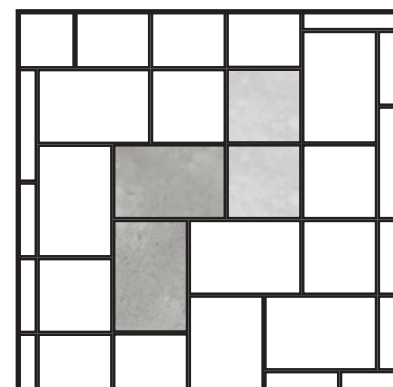

1m<sup>2</sup> 20x30 - 61,9% m<sup>2</sup>  
20x20 - 38,1% m<sup>2</sup>

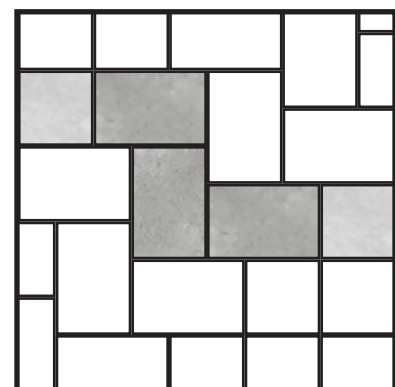

1m<sup>2</sup> 20x30 - 76,1% m<sup>2</sup>  
20x20 - 23,9% m<sup>2</sup>

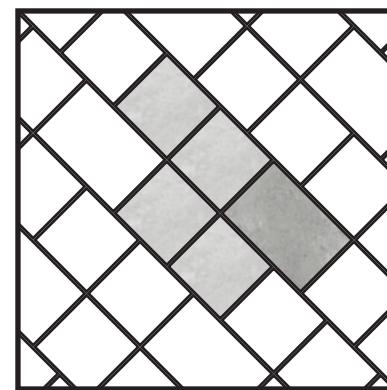

1m<sup>2</sup> 20x30 - 26% m<sup>2</sup>  
20x20 - 74% m<sup>2</sup>

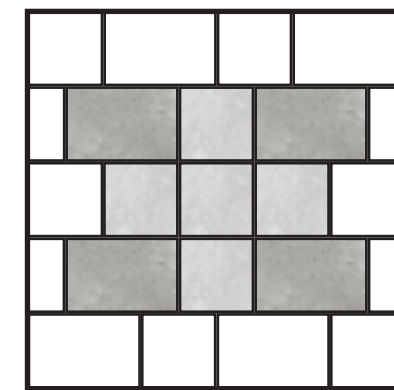

1m<sup>2</sup> 20x30 - 61,9% m<sup>2</sup>  
20x20 - 38,1% m<sup>2</sup>

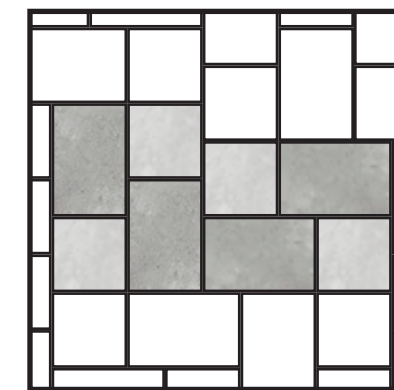

1m<sup>2</sup> 20x30 - 58,1% m<sup>2</sup>  
20x20 - 41,9% m<sup>2</sup>

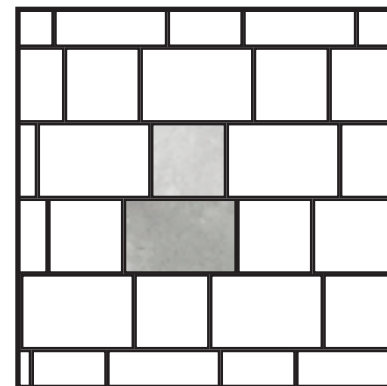

1m<sup>2</sup> 20x30 - 42,5% m<sup>2</sup>  
20x20 - 57,5% m<sup>2</sup>

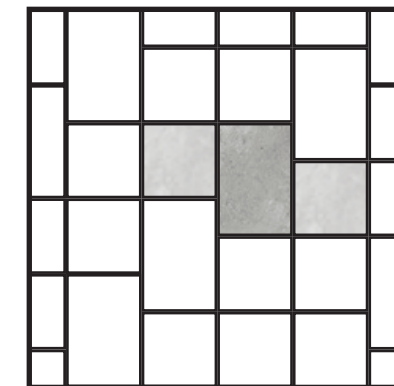

1m<sup>2</sup> 20x30 - 47,9% m<sup>2</sup>  
20x20 - 52,1% m<sup>2</sup>

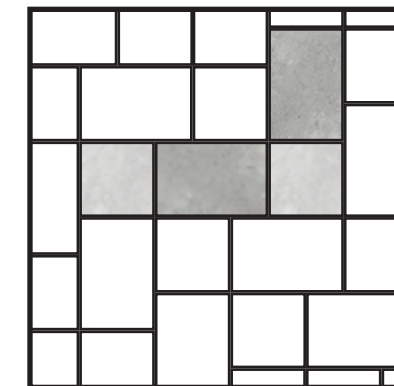

1m<sup>2</sup> 20x30 - 58,1% m<sup>2</sup>  
20x20 - 41,9% m<sup>2</sup>

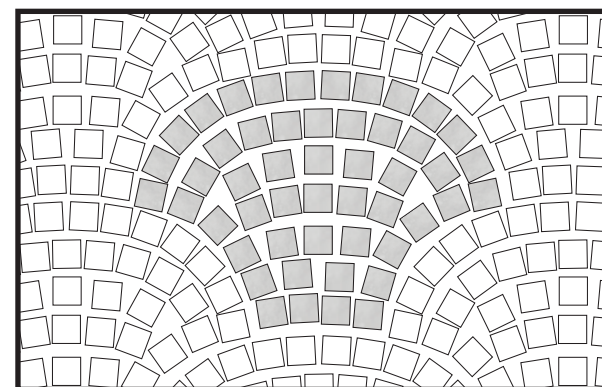

15m<sup>2</sup> 20x30 - 0% m<sup>2</sup>  
20x20 - 100% m<sup>2</sup>

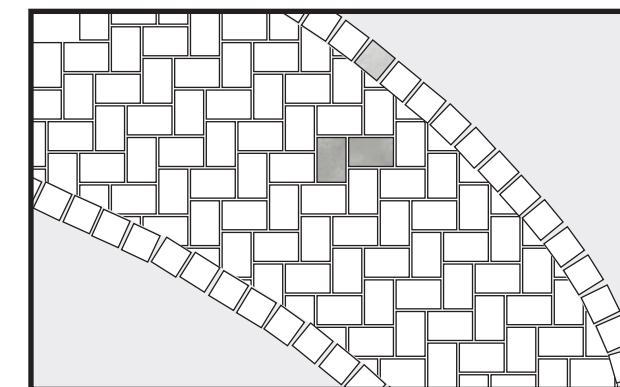

15m<sup>2</sup> 20x30 - 87,2% m<sup>2</sup>  
20x20 - 12,8% m<sup>2</sup>





PELDAÑO INCISIÓN PETRAE / INCISION STEP



PELDAÑO RECTO PETRAE / STRAIGHT STEP





RODAPIÉ PETRAE / SKIRTING

piezas especiales por tipología de producto • special pieces by product type

PAVIMENTO PASTA ROJA / RED BODY FLOOR TILES

Producto - Formato	45X45	20X60
RODAPIÉ ROMO	 7,4X45 / P405 Pz/Cj 40 Kg/Cj 23,00 (A) 45 Cm (B) 7,4 Cm	 7,4X60 / P410 Pz/Cj 22 Kg/Cj 18,50 (A) 60 Cm (B) 17,4 Cm

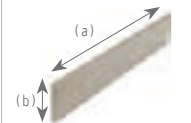
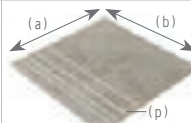
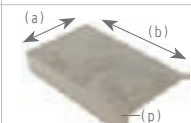
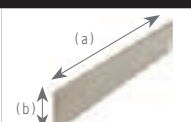
PAVIMENTO PORCELÁNICO ESMALTADO / GLAZED PORCELAIN FLOOR TILE

Producto - Formato	75X75	60X60/30X60	45X45	30,3X61,3
RODAPIÉ ROMO	 9X75 / P460 PZ/CJ 10 KG/CJ 17,00 (A) 75 Cm (B) 9 Cm	 9X60 / P475 / P495 PZ/CJ 18 KG/CJ 24,12 (A) 60 Cm (B) 9 Cm	 9X45 / P505 PZ/CJ 22 KG/CJ 19,36 (A) 45 Cm (B) 9 Cm	 9X61,3 / P490 PZ/CJ 22 KG/CJ 24,60 (A) 61,3 Cm (B) 9 Cm
*PELDAÑO	 30X75 / P240 PZ/CJ 6 KG/CJ 33,60 (A) 30 Cm (B) 75 Cm (P) 0,2 Cm	 30X60 / P255 / P275 PZ/CJ 6 KG/CJ 22,10 (A) 30 Cm (B) 60 Cm (P) 0,2 Cm	 30X45 / P300 PZ/CJ 6 KG/CJ 17,00 (A) 30 Cm (B) 45 Cm (P) 0,2 Cm	 30,3X61,3 / P270 PZ/CJ 6 KG/CJ 22,10 (A) 30,3 Cm (B) 61,3 Cm (P) 0,2 Cm
PELDAÑO GRADONE	 30X75 / P080 PZ/CJ 2 KG/CJ 14 (A) 30 Cm (B) 75 Cm (P) 3,2 Cm	 30X60 / P095 / P110 PZ/CJ 2 KG/CJ 8,70 (A) 30 Cm (B) 60 Cm (P) 3,2 Cm	 30X45 / P135 PZ/CJ 2 KG/CJ 5,66 (A) 30 Cm (B) 45 Cm (P) 3,2 Cm	 30,3X61,3 / P105 PZ/CJ 2 KG/CJ 8,50 (A) 30 Cm (B) 61,3 Cm (P) 3,2 Cm
Producto - Formato	60,8X60,8	60,8X60,8 (F)	20X120 (F)	60X120 (F)
RODAPIÉ ROMO	 9X60,8 / P470 PZ/CJ 18 KG/CJ 24,4 (A) 60,8 Cm (B) 9 Cm	 9X60,8 / P485 PZ/CJ 24 KG/CJ 26 (A) 60,8 Cm (B) 9 Cm	 9X120 / P445 PZ/CJ 12 KG/CJ 28 (A) 120 Cm (B) 9 Cm	 9X120 / P445 PZ/CJ 12 KG/CJ 28 (A) 120 Cm (B) 9 Cm
*PELDAÑO	 30X60,8 / P250 PZ/CJ 6 KG/CJ 20,83 (A) 30 Cm (B) 60,8 Cm (P) 0,2 Cm	 30X60,8 / P265 PZ/CJ 6 KG/CJ 20,83 (A) 30 Cm (B) 60,8 Cm (P) 0,2 Cm	 20X120 / P225 PZ/CJ 6 KG/CJ 25 (A) 30 Cm (B) 120 Cm (P) 0,2 Cm	 30X120 / P210 PZ/CJ 5 KG/CJ 34 (A) 30 Cm (B) 120 Cm (P) 0,2 Cm
PELDAÑO GRADONE	 30X60,8 / P090 PZ/CJ 2 KG/CJ 24,17 (A) 30 Cm (B) 60,8 Cm (P) 3,2 Cm	 30X60,8 / P090 PZ/CJ 2 KG/CJ 24,17 (A) 30 Cm (B) 60,8 Cm (P) 3,2 Cm	 20X120 / P065 PZ/CJ 3 KG/CJ 15 (A) 30 Cm (B) 120 Cm (P) 3,2 Cm	 30X120 / P050 PZ/CJ 2 KG/CJ 27,78 (A) 30 Cm (B) 120 Cm (P) 3,2 Cm



PAVIMENTO PORCELÁNICO PULIDO / POLISHED PORCELAIN FLOOR TILE

Producto - Formato		75X75	60X120	60X60 / 30X60	120X120
RODAPIÉ ROMO		9X75 / P465 PZ/CJ 10 KG/CJ 17,00 (A) 75 Cm (B) 9 Cm	9X120 / P435 / P440 (HP) PZ/CJ 10 KG/CJ 28,00 (A) 120 Cm (B) 9 Cm	9X60 / P480 / P500 PZ/CJ 18 KG/CJ 24,12 (A) 60 Cm (B) 9 Cm	9X120 / P435 / P440 (HP) PZ/CJ 10 KG/CJ 28,00 (A) 120 Cm (B) 9 Cm
*PELDAÑO		30X75 / P245 PZ/CJ 6 KG/CJ 33,60 (A) 30 Cm (B) 75 Cm (P) 0,2 Cm	30X120 / P200 / P205 (HP) PZ/CJ 6 KG/CJ 22,10 (A) 30 Cm (B) 60 Cm (P) 0,2 Cm	30X60 / P260 / P280 PZ/CJ 6 KG/CJ 17,00 (A) 30 Cm (B) 45 Cm (P) 0,2 Cm	30X120 / P200 / P205 (HP) PZ/CJ 4 KG/CJ 38,00 (A) 30 Cm (B) 120 Cm (P) 0,2 Cm
PELDAÑO GRADONE		30X75 / P085 PZ/CJ 2 KG/CJ 14 (A) 30 Cm (B) 75 Cm (P) 3,2 Cm	30X120 / P040 / P045 (HP) PZ/CJ 2 KG/CJ 20 (A) 30 Cm (B) 120 Cm (P) 3,2 Cm	30X60 / P100 / P115 PZ/CJ 2 KG/CJ 8,70 (A) 30 Cm (B) 60 Cm (P) 3,2 Cm	30X120 / P040 / P045 (HP) PZ/CJ 2 KG/CJ 20 (A) 30 Cm (B) 120 Cm (P) 3,2 Cm
Producto - Formato		90X180	90X90	75X150	
RODAPIÉ ROMO		9X90 / P455 PZ/CJ 11 KG/CJ 21 (A) 90 Cm (B) 9 Cm	9X90 / P455 PZ/CJ 11 KG/CJ 21,8 (A) 60,8 Cm (B) 9 Cm	8X150 / P425 PZ/CJ 6 KG/CJ 17,5 (A) 150 Cm (B) 9 Cm	-
*PELDAÑO		-	45X90 / P235 PZ/CJ 3 KG/CJ 19,14 (A) 30 Cm (B) 90 Cm (P) 0,2 Cm	-	-
PELDAÑO GRADONE		30X180 / P010 PZ/CJ 3 KG/CJ 45 (A) 30 Cm (B) 180 Cm (P) 3,2 Cm	30X90 / P075 PZ/CJ 1 KG/CJ 11 (A) 30 Cm (B) 90 Cm (P) 3,2 Cm	25X150 / P025 PZ/CJ 2 KG/CJ 26,67 (A) 30 Cm (B) 150 Cm (P) 3,2 Cm	-

PAVIMENTO PORCELÁNICO 20MM / 20MM THICKNESS FLOOR TILE

Producto - Formato		61X61/60,5X60,5	60X120	75X75	76X76
RODAPIÉ ROMO		9X61 / P454 / P550 PZ/CJ 10 KG/CJ 30 (A) 61 Cm (B) 9 Cm	9X120 / P530 PZ/CJ 10 KG/CJ 30 (A) 120 Cm (B) 9 Cm	9X75 / P540 PZ/CJ 10 KG/CJ 30 (A) 75 Cm (B) 9 Cm	9X76 / P535 PZ/CJ 10 KG/CJ 30 (A) 76 Cm (B) 9 Cm
*PELDAÑO		30X60,5 / P320 PZ/CJ 3 KG/CJ 45,82 (A) 30 Cm (B) 60,5 Cm (P) 0,2 Cm	-	-	-

PAVIMENTO PORCELÁNICO TÉCNICO / PORCELÁNICO MADERAS / TECHNICAL PORCELAIN FLOOR TILE/ WOOD PORCELAIN

Producto - Formato		75X75	60X120	20X120	60X60/30X60
RODAPIÉ ROMO		9X75 / P460 PZ/CJ 10 KG/CJ 17,00 (A) 75 Cm (B) 9 Cm	9X120 / P430 PZ/CJ 10 KG/CJ 28,00 (A) 120 Cm (B) 9 Cm	9X120 / P430 PZ/CJ 10 KG/CJ 28,00 (A) 120 Cm (B) 9 Cm	9X60 / P475 / P495 PZ/CJ 18 KG/CJ 24,12 (A) 60 Cm (B) 9 Cm
*PELDAÑO		30X75 / P240 PZ/CJ 6 KG/CJ 33,60 (A) 30 Cm (B) 75 Cm (P) 0,2 Cm	30X120 / P195 PZ/CJ 4 KG/CJ 38,00 (A) 30 Cm (B) 120 Cm (P) 0,2 Cm	20X120 / P215 PZ/CJ 6 KG/CJ 36,00 (A) 20 Cm (B) 75 Cm (P) 0,2 Cm	30X60 / P250 / P270 PZ/CJ 6 KG/CJ 22,10 (A) 30 Cm (B) 120 Cm (P) 0,2 Cm
PELDAÑO GRADONE		30X75 / P080 PZ/CJ 2 KG/CJ 14 (A) 30 Cm (B) 75 Cm (P) 3,2 Cm	30X120 / P035 PZ/CJ 2 KG/CJ 20 (A) 30 Cm (B) 120 Cm (P) 3,2 Cm	30X120 / P055 PZ/CJ 3 KG/CJ 15 (A) 30 Cm (B) 120 Cm (P) 3,2 Cm	30X60 / P095 / P110 PZ/CJ 2 KG/CJ 8,70 (A) 30 Cm (B) 60 Cm (P) 3,2 Cm
Producto - Formato		45X45	30,3X61,3	45X90	120X120
RODAPIÉ ROMO		9X45 / P505 PZ/CJ 22 KG/CJ 19,36 (A) 45 Cm (B) 9 Cm	9X61,3 / P490 PZ/CJ 22 KG/CJ 24,60 (A) 61,3 Cm (B) 9 Cm	9X90 / P450 PZ/CJ 11 KG/CJ 21,8 (A) 45 Cm (B) 9 Cm	9X120 / P430 PZ/CJ 10 KG/CJ 28 (A) 120 Cm (B) 9 Cm
*PELDAÑO		30X45 / P300 PZ/CJ 6 KG/CJ 17,00 (A) 30 Cm (B) 45 Cm (P) 0,2 Cm	30,3X61,3 / P270 PZ/CJ 6 KG/CJ 22,10 (A) 30,3 Cm (B) 61,3 Cm (P) 0,2 Cm	30X90 / P230 PZ/CJ 6 KG/CJ 28,00 (A) 30 Cm (B) 45 Cm (P) 0,2 Cm	30X120 / P195 PZ/CJ 4 KG/CJ 38 (A) 30 Cm (B) 120 Cm (P) 0,2 Cm
PELDAÑO GRADONE		30X45 / P135 PZ/CJ 2 KG/CJ 5,66 (A) 30 Cm (B) 45 Cm (P) 3,2 Cm	30X61,3 / P105 PZ/CJ 2 KG/CJ 8,50 (A) 30,3 Cm (B) 61,3 Cm (P) 3,2 Cm	30X90 / P070 PZ/CJ 1 KG/CJ 11 (A) 30 Cm (B) 90 Cm (P) 3,2 Cm	30X120 / P035 PZ/CJ 2 KG/CJ 20 (A) 30 Cm (B) 120 Cm (P) 3,2 Cm
Producto - Formato		23x120	20x75	25x100	25X150
RODAPIÉ ROMO		9X120 / P520 PZ/CJ 10 KG/CJ 28 (A) 120 Cm (B) 9 Cm	9X75 / P525 PZ/CJ 10 KG/CJ 28 (A) 120 Cm (B) 9 Cm	8X100 / P515 PZ/CJ 13 KG/CJ 20,8 (A) 100 Cm (B) 8 Cm	8X150 / P420 PZ/CJ 6 KG/CJ 17,5 (A) 100 Cm (B) 8 Cm
*PELDAÑO		23X120 / P290 PZ/CJ 5 KG/CJ 28,80 (A) 23 Cm (B) 120 Cm (P) 0,2 Cm	20X75 / P295 PZ/CJ 5 KG/CJ 28,80 (A) 20 Cm (B) 75 Cm (P) 0,2 Cm	25X100 / P285 PZ/CJ 6 KG/CJ 26 (A) 25 Cm (B) 100 Cm (P) 0,2 Cm	-
PELDAÑO GRADONE		-	-	25X100 / P120 PZ/CJ 2 KG/CJ 24,17 (A) 25 Cm (B) 100 Cm (P) 3,2 Cm	25X150 / P030 PZ/CJ 2 KG/CJ 26,67 (A) 25 Cm (B) 150 Cm (P) 3,2 Cm



# packing list

## PAVIMENTO PASTA ROJA / RED BODY FLOOR TILES

FORMATO	PZ / CJ	M2 / CJ	CJ/PL	M2/PL	KG/CJ	KG/PL
20x60	9	1,08	80	86,4	21,08	1706,4
31x31	16	1,6	54	86,4	27	1478
45x45	7	1,42	52	73,84	25,5	1346

## REVESTIMIENTO PASTA ROJA / RED BODY WALL TILES

FORMATO	PZ / CJ	M2 / CJ	CJ/PL	M2/PL	KG/CJ	KG/PL
20x60	9	1,08	80	86,4	17,9	1452
25x50	14	1,75	48	84	24,75	1208
25x50 PIEDRAS	14	1,75	64	112	23,3	1511,2
25x50 RLV	12	1,5	48	72	22,5	1100
25x70	9	1,58	64	101,12	24,64	1596,96
30x90	5	1,35	48	64,8	27,8	1354,4
30x90 RLV	6	1,62	48	77,76	28,8	1402,4
31,6x60	8	1,52	48	72,96	26	1268
33,3x55	10	1,84	48	88,32	28	1364
33,3x55 RLV	10	1,84	48	88,32	26,6	1296,8
34x50	9	1,5	48	72	24,7	1205,6

## PORCELÁNICO PASTA ROJA / PORCELAIN RED BODY

FORMATO	PZ / CJ	M2 / CJ	CJ/PL	M2/PL	KG/CJ	KG/PL
31,2x31,2	12	1,17	51	59,67	26	1346

## REVESTIMIENTO PASTA BLANCA / WHITE BODY WALL TILES

FORMATO	PZ / CJ	M2 / CJ	CJ/PL	M2/PL	KG/CJ	KG/PL
20x60	9	1,08	64	69,12	17,9	1165,6
25x50	14	1,75	48	84	24,75	1208
25x75 (ARG)	1	1,31	48	62,88	21	1028
30,3x60,5	7	1,28	60	76,8	20,6	1256
36x80	4	1,15	54	62,1	18,5	1019
7,5x30 Rvto	25	0,56	121	67,76	9	1109

## REVESTIMIENTO PASTA BLANCA RECTIFICADA / RECTIFIED WHITE BODY WALL TILES









FORMATO	PZ / CJ	M2 / CJ	CJ/PL	M2/PL	KG/CJ	KG/PL
30x60	8	1,44	32	46,08	24,3	797,6
30x60 (F)	9	1,62	72	116,64	20	1460
30x90	4	1,08	64	69,12	18,75	1220
33,3x100	6	2	48	96	24	1172
33,3x100 RLV	5	1,67	48	80,16	25	1220
40x120 (ARG)	3	1,44	20	28,8	25,5	530









## PORCELÁNICO / PORCELAIN TILES

FORMATO	PZ / CJ	M2 / CJ	CJ/PL	M2/PL	KG/CJ	KG/PL
120x120	1	1,44	36	51,84	38,4	1402,4
120x120 (CONT 40")	1	1,44	36	51,84	38,4	1402,4
15x90	9	1,21	45	54,45	27,6	1262
16.3x51.7	9	0,76	55	41,8	20	1120
17x52	10	0,89	55	48,95	21,4	1197
17x52 (F)	17	1,5	55	82,5	21,75	1216,25
20x120	6	1,44	44	63,36	32	1428
20x120 (F)	7	1,68	44	73,92	32	1428
20x75	7	1,05	72	75,6	18,4	1344,8
22,3x22,3	20	1	45	45	22,5	1032,5
22,5x180	3	1,21	40	48,4	34	1380
23x120	5	1,38	45	62,1	21,4	1433,9
25.8x29 HEXAGON	18	1	48	48	22,5	1100
25x100	6	1,5	36	54	28,5	1046
25x150	4	1,5	40	60	35	1420
30,3x61,3	7	1,3	40	52	26	1060
30x180	3	1,62	30	48,6	45	1370
30x60	7	1,26	40	50,4	24,1	984
30x60 (C)	6	1,08	48	51,84	22	1076
45x45	6	1,22	52	63,44	25,2	1330,4
45x45 (F)	7	1,42	52	73,84	26,13	1378,76
45x45 (RECTIF.)	6	1,22	52	63,44	26,3	1387,6
45x90	3	1,21	44	53,24	28,7	1282,8
60,5x60,5(20mm)	2	0,73	30	21,9	32,8	1004
60,8x60,8	4	1,48	30	44,4	31	950
60,8x60,8 (F)	5	1,85	30	55,5	33,5	1025
60x120	2	1,44	32	46,08	34	1108
60x120 (F)	2	1,44	36	51,84	27,7	1017,2
60x120 (20mm)	1	0,72	32	23,04	34,5	1124
60x60	4	1,44	30	43,2	30,2	926
60x60 (F)	5	1,8	30	54	31	950
61x61(20mm)	2	0,74	30	22,2	33	1010
75,5x75,5(20mm)	1	0,57	45	25,65	27,1	1239,5
75x150	1	1,13	40	45,2	28	1140
75x75	3	1,69	30	50,7	41,2	1256
76x76 (20mm)	1	0,58	45	26,1	27,35	1250,75
90x180	1	1,62	24	38,88	45,5	1112
90x90	2	1,62	27	43,74	42	1154





















CARACTERÍSTICAS TÉCNICAS REVESTIMIENTO MONOPOROSA / TECHNICAL FEATURES FOR MONOPOROSA WALL TILES

	GRUPO BIII (GL) Absorción de agua > 10% GROUP BIII (GL) Water absorption > 10%	NORMAS DE ENSAYO STANDARD	VALORES PRESCRITOS NORMA EN 14411 / VALUE REQUIRED BY EN 14411 STANDARD	VALOR MEDIO AVERAGE VALUE
	Características dimensionales Dimensional features	ISO 10545-2		Cumple la norma Conforms to standard
	Absorción de agua Water absorption	ISO 10545-3	> 10%	16%
	Resistencia a la flexión Modulus of rupture Fuerza de rotura Breaking strength	ISO 10545-4	> 15 N / mm2 > 600 N	15 - 25 N/ mm2 400 N
	Resistencia a la abrasión superficial Resistance to surface abrasion	ISO 10545-7	Clase indicada por el fabricante Abrasion class indicated by the manufacturer /	No aplica Not apply
	Dilatación térmica lineal Linear thermal expansion	ISO 10545-8	Método de ensayo disponible Test method available	<7,0 x 10-6 °C-1
	Resistencia al choque térmico Thermal shock resistance	ISO 10545-9	Método de ensayo disponible Test method available	Resiste Resists
	Resistencia al cuarteo Crazing resistance / Résistance au tressailage	ISO 10545-11	Exigida Required Exigée	Resiste Resists Résiste
	Resistencia química Chemical resistance	ISO 10545-13	Método de ensayo disponible Test method available Mínimo GB Minimum GB	Cumple la norma Conforms to standard Clase GA Class GA
	Resistencia a las manchas Resistance to stains	ISO 10545-14	Mínimo clase 3 Minimum class 3	Cumple la norma Conforms to standard











	GRUPO BIIa (GL) 3% < Absorción de agua < 6% GROUP BIIa (GL) 3% < Water absorption < 6%	NORMAS DE ENSAYO STANDARD	VALORES PRESCRITOS NORMA EN 14411 / VALUE REQUIRED BY EN 14411 STANDARD	VALOR MEDIO AVERAGE VALUE
	Características dimensionales Dimensional features	ISO 10545-2		Cumple la norma Conforms to standard Satisfait à la norme
	Absorción de agua Water absorption	ISO 10545-3	3% < E < 6%	5%
	Resistencia a la flexión Modulus of rupture Fuerza de rotura Breaking strength	ISO 10545-4	> 22 N / mm² > 1000 N	30 - 40 N/ mm2 1100 - 1900 N
	Resistencia a la abrasión superficial Resistance to surface abrasion	ISO 10545-7	Clase indicada por el fabricante Abrasion class indicated by the manufacturer	No aplica Not apply
	Dilatación térmica lineal Linear thermal expansion	ISO 10545-8	Método de ensayo disponible Test method available	<7,0 x 10-6 °C-1
	Resistencia al choque térmico Thermal shock resistance	ISO 10545-9	Método de ensayo disponible	Resiste Resists
	Resistencia al cuarteo Crazing resistance	ISO 10545-11	Exigida Required	Resiste Resists
	Resistencia química Chemical resistance	ISO 10545-13	Método de ensayo disponible Test method available Mínimo GB Minimum GB	Cumple la norma Conforms to standard / Clase GA Class GA
	Resistencia a las manchas Resistance to stains	ISO 10545-14	Mínimo clase 3 Minimum class 3	Cumple la norma Conforms to standard

CARACTERÍSTICAS TÉCNICAS PAVIMENTO PASTA ROJA / TECHNICAL FEATURES CERAMIC FLOOR TILES

CARACTERÍSTICAS TÉCNICAS GRES PORCELÁNICO ESMALTADO / TECHNICAL FEATURES GLAZED PORCELAIN TILES

	GRUPO BIa (GL) Absorción de agua < 0,5% GROUP BIa (GL) Water absorption < 0,5%	NORMAS DE ENSAYO STANDARD	VALORES PRESCRITOS NORMA EN 14411 / VALUE REQUIRED BY EN 14411 STANDARD	VALOR MEDIO AVERAGE VALUE
	Características dimensionales Dimensional features	ISO 10545-2		Cumple la norma Conforms to standard
	Absorción de agua / Water absorption	ISO 10545-3	< 0,5%	0,1%
	Resistencia a la flexión Modulus of rupture Fuerza de rotura Breaking strength	ISO 10545-4	> 35 N / mm2 > 1300 N	35 - 45 N/ mm2 1600 - 2400 N
	Resistencia a la abrasión superficial Resistance to surface abrasion	ISO 10545-7	Clase indicada por el fabricante Abrasion class indicated by the manufacturer /	Según Modelos According to models
	Dilatación térmica lineal Linear thermal expansion	ISO 10545-8	Método de ensayo disponible Test method available	<7,0 x 10-6 °C-1
	Resistencia al choque térmico Thermal shock resistance	ISO 10545-9	Método de ensayo disponible Test method available	Resiste Resists
	Resistencia al cuarteo Crazing resistance	ISO 10545-11	Exigida Required	Resiste Resists
	Resistencia a la helada / Frost resistance	ISO 10545-12	Método de ensayo disponible Test method available	Resiste Resists
	Resistencia química Chemical resistance	ISO 10545-13	Método de ensayo disponible Test method available Mínimo GB Minimum GB	Cumple la norma Conforms to standard Clase GA Class GA
	Resistencia a las manchas Resistance to stains	ISO 10545-14	Mínimo clase 3 Minimum class 3	Cumple la norma Conforms to standard
	GRUPO BIb (GL) Absorción de agua 0,5% < E < 3% GROUPE BIb (GL) Water absorption 0,5% < E < 3%	NORMAS DE ENSAYO STANDARD	VALORES PRESCRITOS NORMA EN 14411 / VALUE REQUIRED BY EN 14411 STANDARD	VALOR MEDIO AVERAGE VALUE
	Características dimensionales Dimensional features	ISO 10545-2		Cumple la norma Conforms to standard
	Absorción de agua Water absorption	ISO 10545-3	0,5% < E < 3%	2%
	Resistencia a la flexión Modulus of rupture Fuerza de rotura Breaking strength	ISO 10545-4	> 30 N / mm2 > 1100 N	30 - 40 N/ mm2 > 1100 N
	Resistencia a la abrasión superficial Resistance to surface abrasion	ISO 10545-7	Clase indicada por el fabricante Abrasion class indicated by the manufacturer	Según Modelos According to models
	Dilatación térmica lineal Linear thermal expansion	ISO 10545-8	Método de ensayo disponible Test method available	<7,0 x 10-6 °C-1
	Resistencia al choque térmico Thermal shock resistance	ISO 10545-9	Método de ensayo disponible Test method available	Resiste Resists
	Resistencia al cuarteo Crazing resistance	ISO 10545-11	Exigida Required	Resiste Resists
	Resistencia química Chemical resistance	ISO 10545-13	Método de ensayo disponible Test method available Mínimo GB Minimum GB	Cumple la norma Conforms to standard Clase GA Class GA
	Resistencia a las manchas Resistance to stains	ISO 10545-14	Mínimo clase 3 Minimum class 3	Cumple la norma Conforms to standard



	GRUPO BIa (GL) Absorción de agua < 0,5% GROUP BIa (GL) Water absorption < 0,5%	NORMAS DE ENSAYO STANDARD	VALORES PRESCRITOS NORMA EN 14411 / VALUE REQUIRED BY EN 14411 STANDARD	VALOR MEDIO AVERAGE VALUE
	Características dimensionales Dimensional features	ISO 10545-2		Cumple la norma Conforms to standard
	Absorción de agua Water absorption / Absorption d'eau	ISO 10545-3	< 0,5%	0,1%
	Resistencia a la flexión Modulus of rupture	ISO 10545-4	> 35 N / mm <sup>2</sup> > 1300 N	35 - 45 N / mm <sup>2</sup> 1600 - 2400 N
	Resistencia a la flexión Modulus of rupture Fuerza de rotura Breaking strength			
	Resistencia a la abrasión profunda (mm <sup>3</sup> ) Resistance to deep abrasion (mm <sup>3</sup> ) / Résistance à l'abrasion profonde (mm <sup>3</sup> )	ISO 10545-6	Máx. 175 mm <sup>3</sup>	110 - 130 mm <sup>3</sup>
	Dilatación térmica lineal / Linear thermal expansion / Dilatación thermique linéaire	ISO 10545-8	Método de ensayo disponible Test method available	<7,0 x 10 <sup>-6</sup> °C <sup>-1</sup>
	Resistencia al choque térmico Thermal shock resistance / Résistance au choc thermique	ISO 10545-9	Método de ensayo disponible Test method available	Resiste Resists
	Resistencia a la helada Frost resistance / Résistance au gel	ISO 10545-12	Método de ensayo disponible Test method available	Resiste Resists
	Resistencia química Chemical resistance	ISO 10545-13	Método de ensayo disponible Test method available Mínimo UB Minimum UB	Cumple la norma Conforms to standard Clase UA Class UA
	Ácidos y bases Acids and bases Productos de limpieza y reactivos de piscinas Cleaning products and pool reactive agents			
	Resistencia a las manchas Resistance to stains	ISO 10545-14	Mínimo clase 3 Minimum class 3	Cumple la norma Conforms to standard
	Resistencia al deslizamiento Slip Resistance	DIN 51130 DIN 51097 UNE-ENV 12633 ASTM C 1028		Según Modelos According to models





# FOLLOW OUR LATEST NOVELTIES

En Navarti, apostamos por un futuro más limpio. Es por ello que hemos creado este apartado con el fin de mantener actualizado el catálogo a tiempo real y poder compartir las últimas novedades de una manera más dinámica.

Escanea nuestro QR y descubre más...

At Navarti, we are committed to a brighter future cleansed. That is why we have created this section in order to keep updated the catalog in real time and being able to share the latest news in a more dynamic.

Scan our QR and discover more...

*scan me*





# NAVARTI

cerámica

**La reproducción de los colores es aproximada.**

**Navarti se reserva el derecho de alterar o modificar los productos aquí relacionados.**

The reproduction of the colors is approximate.

Navarti reserves the right to alter or amend the products here stated.

**Los códigos de precios y referencias deben verificarse ya que puede haber errores tipográficos. Es recomendable consultar la web ya que cualquier producto de este catálogo puede sufrir cambios en códigos de venta, formatos o packing.**

Price codes and product codes should be checked, since there may be typographical errors. We always recommend consulting the website as the products could undergo price code, format or packing changes.

**En la web también pueden consultar las características técnicas, consejos de colocación , elementos de merchandising o los diversos ambientes de cada una de las colecciones.**

On the website you can also find the technical specifications, installation suggestions, merchandising elements and a variety of room scene pictures for each of the inspirations.