

CATÁLOGO . CATALOG . CATALOGUE



*Valadares*

ORIGINAL BATHROOMS

SINCE 1921

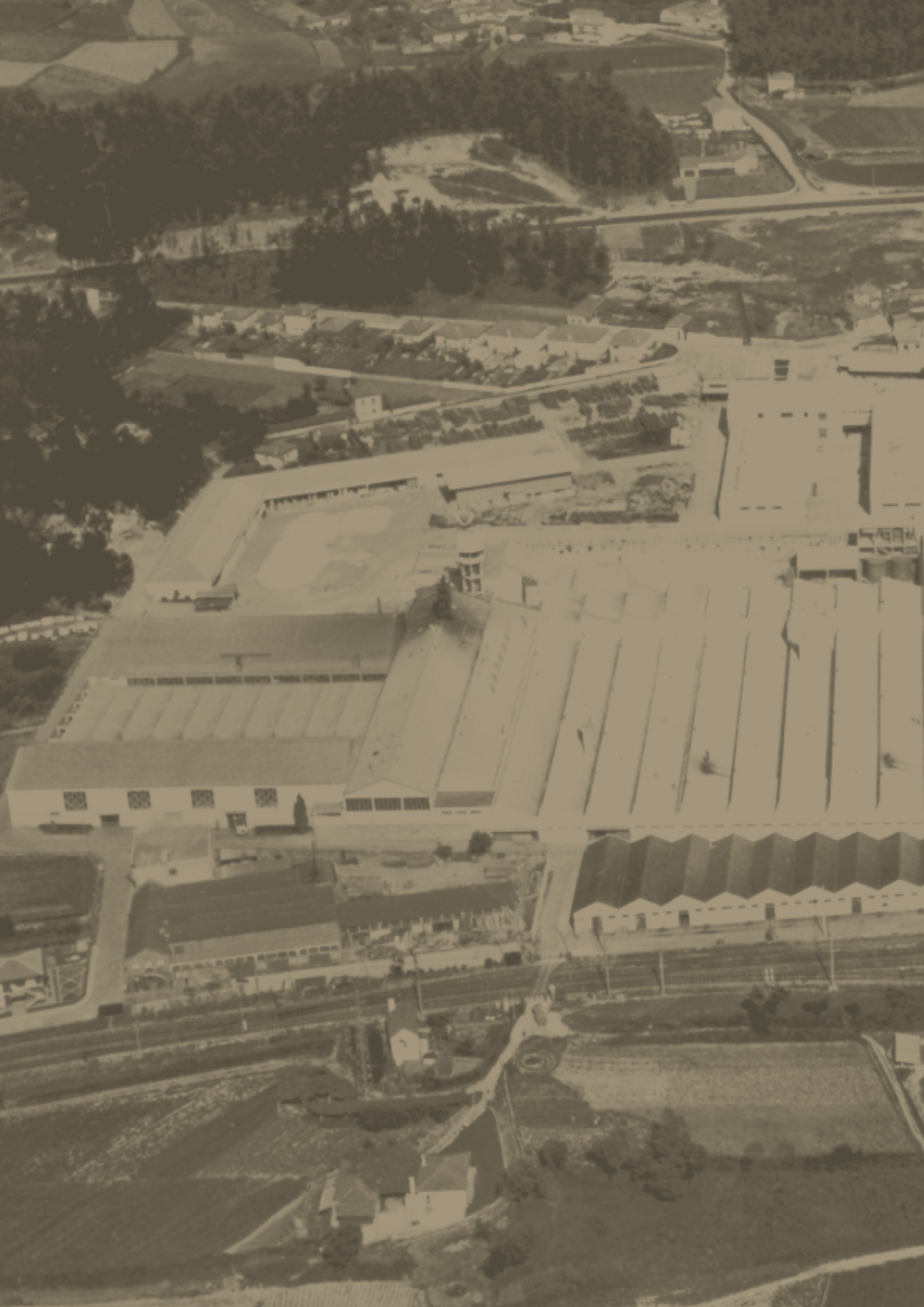



*Valadares*

ORIGINAL BATHROOMS

SINCE 1921



< 2



# CENTENÁRIO

CENTENARIO . CENTENARY . CENTENAIRE

Sediada em Valadares, Vila Nova de Gaia, a ARCH é hoje a empresa que detém, produz e comercializa a marca **Valadares** para mais de 50 países. Ao longo de mais de um século, a Valadares foi construindo uma marca sólida e é hoje internacionalmente reconhecida pela qualidade e inovação.

O projeto **ARCH – Advanced Research Ceramic Heritage** pretende elevar esse conhecimento, o design e a inovação que foram passadas de gerações em gerações e que culminaram no sucesso que hoje a marca representa.

Hoje a ARCH Valadares é a fusão entre a personalidade do seu passado e a ambição de moldar o futuro em novos caminhos. Este é o legado que nos orgulhamos e que hoje queremos continuar a honrar.

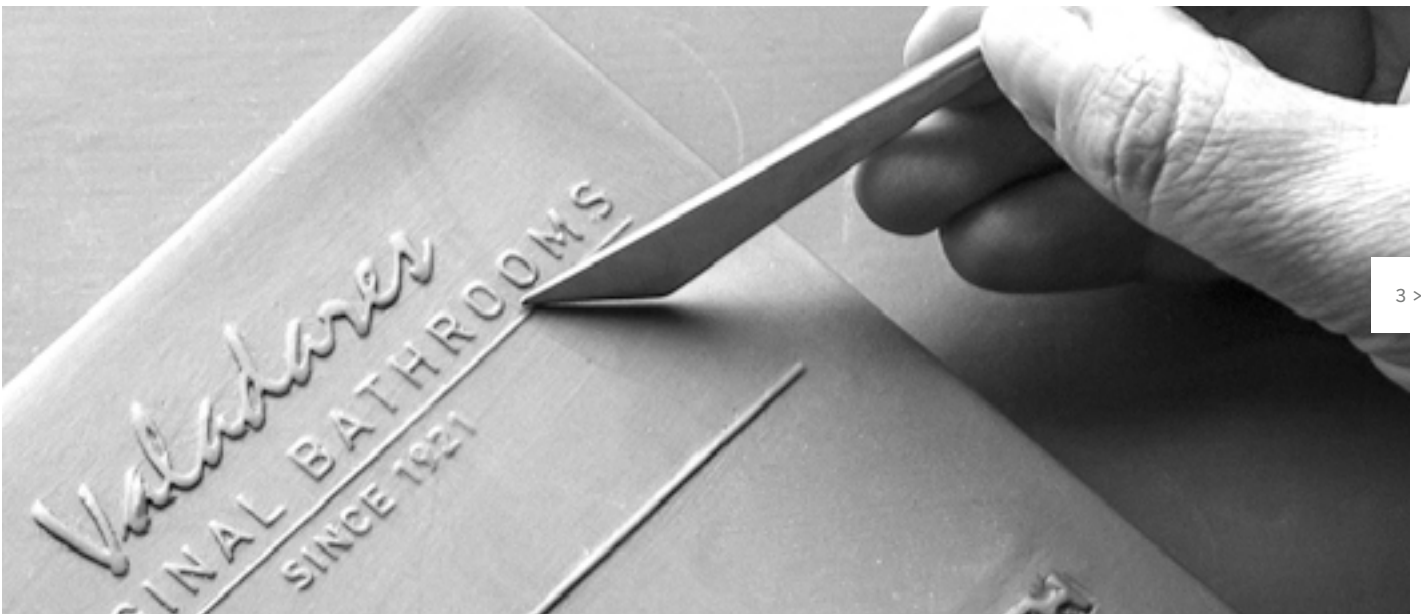

3 >

Con sede en **Valadares**, Vila Nova de Gaia, ARCH es hoy la empresa propietaria, productora y comercializadora de la marca Valadares en más de 50 países. Durante más de un siglo, Valadares ha construido una marca sólida y hoy en día es reconocida internacionalmente por su calidad e innovación.

El proyecto **ARCH – Advanced Research Ceramic Heritage** pretende elevar ese conocimiento, diseño e innovación que se han ido transmitiendo de generación en generación y que culminaron en el éxito que hoy representa la marca.

Hoy ARCH Valadares es la fusión entre la personalidad de su pasado y la ambición de dar forma al futuro de nuevas formas. Este es el legado del que estamos orgullosos y que hoy queremos seguir honrando.

ARCH houses its headquarters in **Valadares**, Vila Nova de Gaia and is nowadays the company that owns, produces and markets the Valadares brand to more than 50 countries. Over more than a century, Valadares has built a solid brand and is now internationally recognized for its quality and innovation.

The **ARCH – Advanced Research Ceramic Heritage** project, intends to elevate this knowledge, design and innovation that have been passed down from generations to generations which culminated in the success that the brand represents today.

Today ARCH Valadares is the fusion between the personality of its past and the ambition to shape the future in new ways. This is the legacy we are proud of and that we want to continue to honor to this date.

Basée à **Valadares**, Vila Nova de Gaia, ARCH est aujourd'hui la société qui possède, produit et commercialise la marque Valadares dans plus de 50 pays. Depuis plus d'un siècle, Valadares a construit une marque solide et est aujourd'hui reconnue internationalement pour sa qualité et son innovation.

Le projet **ARCH – Advanced Research Ceramic Heritage** vise à élever ce savoir, ce design et cette innovation qui se sont transmis de génération en génération et qui ont abouti au succès que la marque représente aujourd'hui.

Aujourd'hui ARCH Valadares est la fusion entre la personnalité de son passé et l'ambition de façonner une nouvelle route pour l'avenir. C'est l'héritage dont nous sommes fiers et qu'aujourd'hui nous voulons continuer à honorer.

# INOVAÇÃO

INNOVACIÓN . INNOVATION

**A sua produção 100% Portuguesa**, aposta no desenvolvimento de novos materiais – **Gresanit, Highcer e Highpor** – e soluções técnicas orientadas para a sustentabilidade e a eficiência ambiental. O conhecimento dos processos de fabrico delicados em cerâmica adquiridos pela marca Valadares, constituem a razão do domínio dos processos Cerâmicos “Hand made” de que hoje a ARCH é detentora. A este argumento acrescenta a condição excepcional de uma durabilidade atestada por **20 anos de garantia técnica**.

**Su producción 100% portuguesa** se centra en el desarrollo de nuevos materiales – **Gresanit, Highcer y Highpor** – y soluciones técnicas orientadas a la sostenibilidad y la eficiencia medioambiental. El conocimiento de los delicados procesos de fabricación en cerámica adquiridos por la marca Valadares, es la razón del dominio de los procesos Cerámicos “Hechos a Mano” del cual ARCH es hoy en día propietaria. A este argumento se suma el excepcional estado de durabilidad atestiguado por una **garantía técnica de 20 años**.

Its 100% Portuguese production focuses on the development of new materials – **Gresanit, Highcer and Highpor** – as well as on technical solutions aimed at sustainability and environmental efficiency. The knowledge of the delicate manufacturing processes in the ceramic industry acquired by the Valadares brand, constitutes the reason for the mastery of “Hand made” Ceramic processes for which ARCH is the actual owner. Added to this argument is the exceptional condition of durability attested by a **20-year technical guarantee**.

< 4

Sa production 100% portugaise se concentre sur le développement de nouveaux matériaux - **Gresanit, Highcer et Highpor** - et de solutions techniques visant la durabilité et l'efficacité environnementale. La connaissance des processus de fabrication délicats en céramique acquise par la marque Valadares, est la raison de la maîtrise des processus céramiques “faits à la main” dont ARCH est aujourd'hui propriétaire. A cet argument s'ajoute la condition exceptionnelle de durabilité attestée par une **garantie technique de 20 ans**.



### **GRESANIT® – cerâmica única no mundo**

Foi desenvolvido como resposta à necessidade de introduzir um material alternativo ao vulgar Grés para produção de artigos de grandes dimensões, mas com maior resistência e mais leves que os existentes. Tem na sua génese uma forte componente relacionada com a Sustentabilidade Ambiental também apresentando melhores características do que o Grés vulgar.

### **GRESANIT® – cerámica única en el mundo**

Nace como respuesta a la necesidad de introducir un material alternativo al gres común para la elaboración de artículos de grandes dimensiones, pero con mayor resistencia y menor peso que los hasta ahora existentes. Tiene en su génesis un fuerte componente relacionado con la Sostenibilidad Medioambiental, mostrando además mejores características que el gres ordinario.

### **GRESANIT® – unique ceramic in the world**

Was developed in response to the need to introduce an alternative material to the common stoneware used for the production of large-sized articles, thus creating a product with greater resistance and lighter than existing ones. Has in its core a strong component related to Environmental Sustainability, also showing better characteristics than ordinary stoneware.

### **GRESANIT® – céramique unique au monde**

A été développé en réponse à la nécessité d'introduire un matériau alternatif au grès commun pour la production d'articles de grande taille, mais avec une plus grande résistance et plus léger que ceux existants. Dans sa genèse une forte composante liée à la durabilité environnementale, présentant également de meilleures caractéristiques que le grès ordinaire.

### **HIGHCER® – um cerâmico altamente resistente**

A ARCH desenvolveu um material que eliminasse a necessidade do revestimento vitrificado, assim o HIGHCER®, material cerâmico com uma resistência consideravelmente superior a qualquer outro material cerâmico atualmente no mercado, destina-se ao desenvolvimento de produtos de aplicação em revestimentos técnicos ou peças sujeitas a utilização exigente.

### **HIGHCER® – un cerâmico increíblemente resistente**

ARCH ha desarrollado un material que elimina la necesidad de un revestimiento vitrificado, por lo que HIGHCER®, un material cerámico con una resistencia considerablemente mayor que cualquier otro material cerámico actualmente en el mercado, está destinado al desarrollo de productos para la aplicación en revestimientos técnicos o piezas sujetas a un uso exigente.

### **HIGHCER® – a highly resistant ceramic**

ARCH has developed a material that eliminates the need for a glazed coating. HIGHCER® is intended for the development of products for application in technical coverings or with a high tear and wear usage. It is a ceramic material with a considerably greater resistance than any other ceramic material currently on the market.

### **HIGHCER® – une céramique hautement résistante**

ARCH a développé un matériau qui élimine le besoin d'un revêtement vitrifié, donc HIGHCER®, un matériau céramique avec une résistance considérablement plus élevée que tout autre matériau céramique actuellement sur le marché, est destiné au développement de produits pour une application dans des revêtements techniques ou des pièces soumises à une utilisation exigeante.

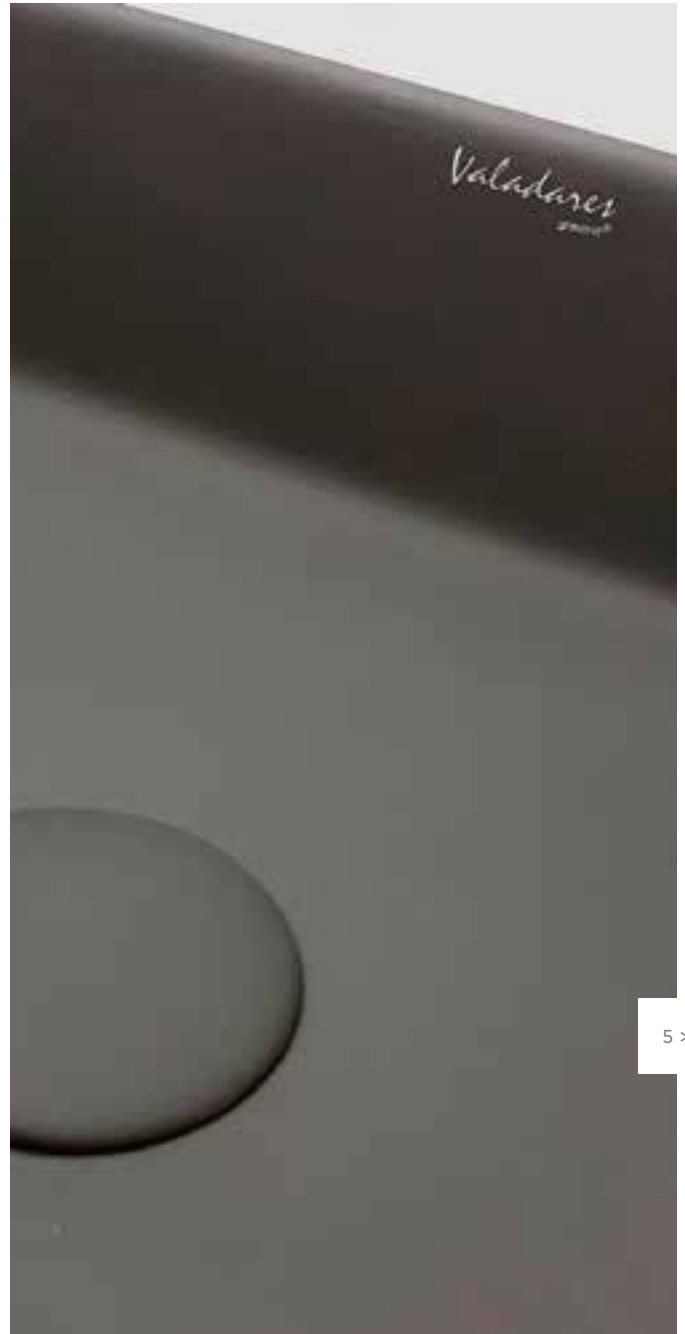
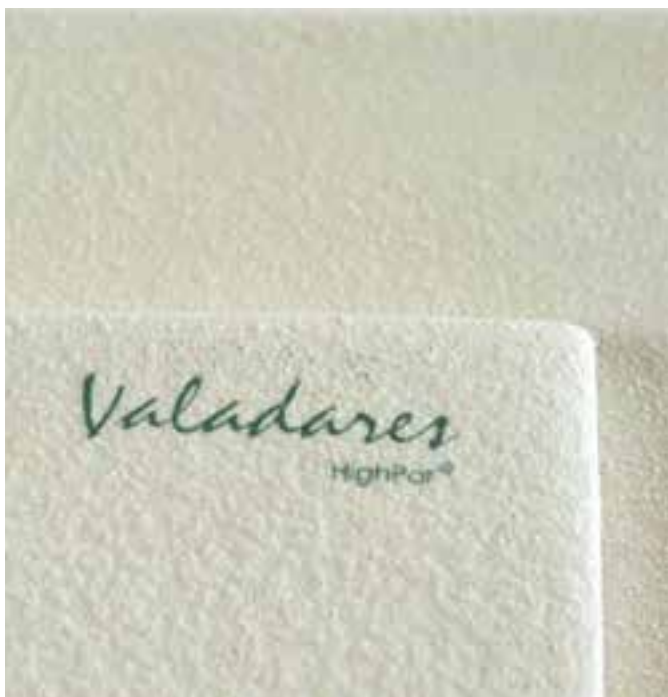

5 >

### **HIGHPOR® – um novo acabamento cerâmico**

A ARCH ainda desenvolveu mais um material, sendo este um vidrado de elevado desempenho antiderrapante, introduzido nas bases cerâmicas. Tem uma **absorção zero e classe C antiderrapante**. É **resistente a qualquer tipo de manchas, de fácil limpeza, resistente ao fogo e de alta resistência a ataques químicos**. O Highpor® é **100% reciclável**, contém **0% de polímeros** e é mais leve do que o vidrado normal.

### **HIGHPOR® – un nuevo acabado cerámico**

ARCH también ha desarrollado otro material, que es un esmalte antideslizante de altas prestaciones, que se introduce en bases cerámicas. Posee **absorción cero y antideslizante clase C**. Es **resistente a todo tipo de manchas, fácil de limpiar, resistente al fuego y muy resistente a los ataques químicos**. Highpor® es **100 % reciclable**, contiene **0 % de polímeros** y es más ligero que el esmalte estándar.

### **HIGHPOR® – a new ceramic finish**

ARCH has also developed yet another material, which is a high-performance non-slip glaze, intended to be applied onto ceramic shower trays. It has **zero absorption and class C non-slip**. It is **immune to any kind of stains, easy to clean, resistant to fire and highly resistant to chemical attacks**. Highpor® is **100% recyclable**, contains **0% polymers** and is lighter than standard glazes.

### **HIGHPOR® – une nouvelle finition céramique**

ARCH a également développé un autre matériau, qui est une glaçure antidérapante haute performance, introduite dans les bases en céramique. Il a une **absorption nulle et un antidérapant de classe C**. Il est **résistant à tout type de taches, facile à nettoyer, résistant au feu et très résistant aux attaques chimiques**. Highpor® est **100 % recyclable**, contient **0 % de polymères** et est plus léger que l'émail standard.

# SIMBOLOGIA

SIMBOLOGY . SYMBOLOGIE



**Descarga eficaz c/ 2,5L/ 4L** · Descarga efectiva c/ 2,5L/ 4L  
· Effective discharge w/ 2,5L/ 4L · Décharge efficace av/ 2,5L/ 4L



**Descarga eficaz c/ 3L/ 5L** · Descarga efectiva c/ 3L/ 5L  
· Effective discharge w/ 3L/ 5L · Décharge efficace av/ 3L/ 5L



**Sanita c/ comprimento 60cm** · Inodoro con longitud 60cm  
WC length 60cm · Toilette avec longueur de 60cm



**Resistência ao escorregamento** · Resistencia a la resbaladad  
Resistance slip · Résistance au glissement



**Estruturas de sanita suspensa com 10 anos de garantia**  
Estructuras para inodoro suspendido con 10 años de garantia  
Conceled systems for wall - hung WC with 10 year warranty  
Bâti-chasse avec garantie de 10 ans



**Artigos cerâmicos com 20 anos de garantia**  
Artículos cerámicos con 20 años de garantia  
Ceramic articles with 20 years warranty  
Articles céramiques avec garantie de 20 an



**Certificação hídrica do autoclismo** · Certificación hidrica  
Hydic certification toilet · Certification hydrique



**Tampo soft-close** · Tapa soft-close  
Soft-close toilet seat · Abattant soft-close



## ABREVIATURAS

ABBREVIATIONS . ABRÉVIATIONS

**SC** - Tampo Soft Close · Tapa Soft-close · Soft-close toilet seat · Soft-close abattant toilette

**CM** - Tampo em contraplacado marítimo · Tapa en laminado marino · Toilet seat in marine plywood · Siège de toilette en contreplaqué marine

**V** - Sanita de descarga vertical · Inodoro de descarga vertical · Vertical outlet toilet · Toilette à décharge verticale

**H** - Sanita de descarga horizontal · Inodoro de descarga horizontal · Horizontal outlet toilet · Toilette à décharge horizontale

**PMR** - Pessoas com mobilidade reduzida · Personas con movilidad reducida · People with reduced mobility · Personnes à mobilité réduite



# CORES

COLORES . COLORS . COULEURS

|    |   |    |   |
|----|---|----|---|
| 23 | Branco Ártico . Blanco ártico . White arctic . Blanc arctique | 00 | Branco . Blanco . White . Blanche                     |
| 46 | Marfim . Marfil . Ivory . Ivoire                              | 10 | Highpor   |
| 18 | Amarilo Saara . Amarillo saara . Yellow saara . Saara jaune   | 20 | Pergamon  |
| 21 | Azul Capri . Azul capri . Blue capri . Bleu capri             | 41 | Rosa Quartz . Rosa cuarzo . Rose quartz . Quartz rose |
| 28 | Verde Jade . Jade verde . Jade green . Vert jade              | 15 | Cappuccino  |
| 13 | Rosa Imperial . Imperial rose . Rose impériale                | 33 | Cereja . Cereza . Cherry . Cerise                     |
| 38 | Cinza Bruma . Gris bruma . Grey bruma . Brume grise           | 50 | Cacau . Cacao . Cocoa . Cacao                         |
| 12 | Azul Pastel . Blue pastel . Bleu pastel                       | 60 | Highcer   |
| 27 | Verde Amazônia . Amazon green . Vert amazone                  | 44 | Azul Petróleo . Blue pétroleum . Bleu pétrole         |
| 37 | Cinza Basalto . Gris basalto . Grey basalt . Gris basalte     | 07 | Azul York . Blue york . Bleu york                     |
| 47 | Ardósia . Pizarra . Slate . Ardoise                           | 48 | Preto . Negro . Black . Noir                          |

7 >

FIND YOUR FAVOURITE **COLOR** TO YOUR BATHROOM

|  | 00                                   | 23  | 46                                  | 20       | 18   | 41  | 21   | 28  | 15         |
|--|--------------------------------------|---|-------------------------------------|----------|--|---|--|---|------------|
|  | BRANCO<br>BLANCO<br>WHITE<br>BLANCHE | BRANCO ÁRTICO<br>BLANCO ÁRTICO<br>WHITE ARTIC<br>BLANC ARCTIQUE | MARFIM<br>MARFIL<br>IVORY<br>IVOIRE | PERGAMON | AMARELO SAARA<br>AMARILLO SAARA<br>YELLOW SAARA<br>SAARA JAUNE | ROSA QUARTZO<br>ROSA CUARZO<br>ROSE QUARTZ<br>QUARTZ ROSE | AZUL CAPRI<br>AZUL CAPRI<br>BLUE CAPRI<br>BLEU CAPRI | VERDE JADE<br>JADE VERDE<br>JADE GREEN<br>VERT JADE | CAPPUCCINO |
| EGG  | •                                    | •   |                                     |          | •  | •   |  |   | •          |
| NAUTILUS   | •                                    | •   |                                     |          |  |   |  |   | •          |
| ONE  | •                                    | •   | •                                   |          | •  | •   |  |   | •          |
| NEOCLÁSSICA  | •                                    | •   |                                     | •        |  |   |  |   |            |
| TWO  | •                                    | •   |                                     |          |  |   |  |   |            |
| LIGHT  | •                                    | •   |                                     |          |  |   |  |   |            |
| 100  | •                                    |   |                                     |          |  |   |  |   |            |
| OPUS   | •                                    |   |                                     |          |  |   |  |   |            |
| OCEANUS  | •                                    |   |                                     |          |  |   |  |   |            |
| JUNIÓR   | •                                    |   |                                     |          |  |   |  |   |            |
| PMR  | •                                    |   |                                     |          |  |   |  |   |            |
| URINÓIS<br>URINARIOS<br>URINALS  | •                                    |   |                                     |          |  |   |  |   |            |
| LAVATÓRIOS POUSAR<br>LAVABOS SOBRE MUEBLE<br>STANDING WASHBASINS<br>LAVABOS À POSER  | •                                    | •   | •                                   |          | •  | •   | •  | •   | •          |
| LAVATÓRIOS ESPECIAIS<br>LAVABOS ESPECIALES<br>SPECIAL WASHBASINS<br>LAVABOS SPÉCIAUX | •                                    | •   |                                     |          |  |   |  |   |            |
| OUTROS LAVATÓRIOS<br>OTROS LAVABOS<br>OTHER WASHBASINS<br>AUTRES LAVABOS             | •                                    |   |                                     |          |  |   |  |   |            |
| BASES DE CHUVEIRO<br>PLATOS DE DUCHA<br>SHOWER TRAYS<br>RECEVEURS DE DOUCHE          | •                                    |   |                                     |          |  |   |  |   |            |
| PEÇAS TÉCNICAS<br>PIEZAS TÉCNICAS<br>TECHNICAL PIECES<br>PIÈCES TECHNIQUES           | •                                    |   |                                     |          |  |   |  |   |            |
| ACESSÓRIOS<br>ACCESORIOS<br>ACCESSORIES<br>ACCESSOIRES                               | •                                    |   |                                     |          |  |   |  |   |            |
| TORNEIRAS LUNA<br>GRIFOS LUNA<br>LUNA TAPS<br>ROBINETS LUNA                          | •                                    | •   |                                     |          |  |   |  |   |            |
| PLACA CERÂMICA<br>ENCIMERA EN CERÁMICA<br>CERAMIC TOP<br>ASSIETTE EN CÉRAMIQUE       | •                                    | •   |                                     |          |  |   |  |   |            |

< 8

## torneiras e estruturas para lavatórios

grifería y estructuras para lavabos .  
taps and structures for washbasins .  
robinets et bâti-chasse pour lavabos



0 Níquel escovado . Niquel pulido .  
Brushed nickel . Nickel brossé



3 Preto mate . Negro mate .  
Black matt . Noir mat



1 Branco . Blanco .  
White . Blanc



4 Dourado . Dorado .  
Gold . D'or



2 Cromado .  
Cromo . Chrome



5 Dourado mate . Dorado mate .  
Gold matt . D'or mat

# MAPA DE CORES

MAPA DE COLORES . COLORS MAP . CARTE DES COULEURS

| 13   | 33                                   | 38   | 12                                       | 50                                 | 27   | 44  | 07                                  | 37   | 47                                     | 98                | 48                              | 10      | 60      |
|--|--------------------------------------|--|--|------------------------------------|--|---|-------------------------------------|--|--|-------------------|---------------------------------|---------|---------|
| ROSA IMPERIAL<br>IMPERIAL ROSE<br>ROSE IMPÉRIALE | CEREJA<br>CEREZA<br>CHERRY<br>CERISE | CINZA BRUMA<br>GRIS BRUMA<br>GREY BRUMA<br>BRUME GRISE | AZUL PASTEL<br>BLUE PASTEL<br>BLEU ASTEL | CACAU<br>CACCAO<br>COCCOA<br>CACAO | VERDE AMAZÔNIA<br>AMAZON GREEN<br>VERT AMAZONE | AZUL PETRÓLEO<br>BLUE PETROLEUM<br>BLEU PÉTROLE | AZUL YORK<br>BLUE YORK<br>BLEU YORK | CINZA BASALTO<br>GRIS BASALTO<br>GREY BASALT<br>GRIS BASALTE | ARDÓSIA<br>PIZARRA<br>SLATE<br>ARDOISE | P&B<br>N&B<br>B&W | PRETO<br>NEGRO<br>BLACK<br>NOIR | HIGHPOR | HIGHCER |
| •  |                                      | •  |  |                                    |  | •   | •                                   | •  | •                                      |                   | •                               |         |         |
|  |                                      | •  |  |                                    |  |   |                                     |  | •                                      |                   | •                               |         |         |
|  |                                      | •  |  |                                    |  | •   | •                                   | •  | •                                      |                   | •                               |         |         |
|  |                                      |  |  |                                    |  |   | •                                   |  | •                                      | •                 | •                               |         |         |
|  |                                      |  |  |                                    |  |   |                                     |  | •                                      | •                 | •                               |         |         |
|  |                                      |  |  |                                    |  |   |                                     |  |  |                   |                                 |         |         |
|  |                                      |  |  |                                    |  |   |                                     |  |  |                   |                                 |         |         |
| •  | •                                    | •  | •  | •                                  | •  | •   | •                                   | •  | •                                      |                   | •                               |         |         |
|  |                                      |  |  |                                    |  | •   |                                     | •  | •                                      |                   | •                               |         |         |
|  |                                      |  |  |                                    |  |   |                                     |  |  |                   |                                 |         |         |
|  |                                      |  |  |                                    |  |   |                                     |  | •                                      |                   |                                 | •       | •       |
|  |                                      |  |  |                                    |  |   |                                     |  |  |                   |                                 |         |         |
|  |                                      |  |  |                                    |  |   |                                     |  | •                                      |                   | •                               |         |         |
|  |                                      |  |  |                                    |  |   |                                     |  | •                                      |                   | •                               |         |         |

9 >

Outras cores sob consulta  
Otros colores bajo consulta  
Other colours on request  
Autres couleurs sur demande



8 **Inox escovado . Acero cepillado .**  
Brushed stainless steel . Acier inoxydable brossé

original bathrooms since 1921

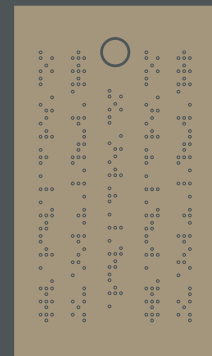

ORIGINAL BA

# ÍNDICE

INDEX

|  |     |
|--|-----|
| <b>COLEÇÕES SANITÁRIAS</b><br>COLECCIONES SANITARIAS . SANITARY COLLECTIONS . COLLECTIONS SANITAIRES   | 13  |
| <b>ESTRUTURAS</b><br>ESTRUCTURAS . STRUCTURES . BÂTI-CHASSE  | 95  |
| <b>LAVATÓRIOS</b><br>LAVABOS . WASHBASINS  | 103 |
| <b>PLACA CERÂMICA   ESTRUTURAS DE BANCADA   MÓVEIS</b><br>ENCIMERA EN CERÁMICA . CERAMIC TOP . ASSIETTE EN CÉRAMIQUE  <br>ESTRUCTURAS DE ENCIMERA . TOP FRAMES . STRUCTURES POUR ASSIETTES   MUEBLES . FURNITURE . MEUBLES | 129 |
| <b>TORNEIRAS</b><br>GRIFERIA . TAPS . ROBINETS   | 139 |
| <b>ESPAÇOS PÚBLICOS</b><br>ESPACIOS PÚBLICOS . PUBLIC SPACES . ESPACES PUBLICS   | 179 |
| <b>BASES DE CHUVEIRO</b><br>PLATOS DE DUCHA . SHOWER TRAYS . RECEVEURS DE DOUCHE   | 195 |
| <b>BANHEIRAS</b><br>BAÑERAS . BATHTUBS . BAINOIRES   | 203 |
| <b>RESGUARDOS</b><br>MAMPARAS . SHOWER CABINS . PANNEAUX DOUCHE  | 209 |
| <b>ACESSÓRIOS CERÂMICOS</b><br>ACCESORIOS CERÁMICA . CERAMIC ACCESSORIES . ACCESOIRES CÉRAMIQUES   | 215 |
| <b>CONDIÇÕES GERAIS DE VENDA</b><br>CONDICIONES GENERALES DE VENTA . GENERAL CONDITIONS OF SALE . CONDITIONS GÉNÉRALES DE VENTE  | 223 |

*Valadares*



# COLEÇÕES SANITÁRIAS

COLECCIONES SANITARIAS . SANITARY COLLECTIONS . COLLECTIONS SANITAIRES

EGG

*p. 14 - 21*

NAUTILUS

*p. 22 - 29*

ONE

*p. 30 - 37*

TWO

*p. 38 - 49*

LIGHT

*p. 50 - 53*

NEOCLÁSSICA

*p. 54 - 69*

100

*p. 70 - 77*

OPUS

*p. 78 - 85*

OCEANUS

*p. 86 - 93*



< 14

A nossa EGG, desenhada pela designer de interiores Gracinha Viterbo, que com o seu toque pessoal, conferiu-lhe a sumptuosidade das linhas intemporais circulares. A nossa gama mais exclusiva.

Nuestra colección EGG fue diseñada por la interiorista Gracinha Viterbo, quien con su toque personal ha conseguido transmitir una suntuosidad de líneas intemporales circulares. Es nuestra colección más exclusiva

Our EGG, designed by the interior designer Gracinha Viterbo, who, with her personal touch, gave it the sumptuousness of the timeless circular lines. Our most exclusive range.

Notre EGG, conçu par l'architecte d'intérieur Gracinha Viterbo, qui, avec sa touche personnelle, lui a donné la somptuosité des lignes circulaires intemporelles. Notre gamme la plus exclusive.



# EGG

compacta . para tanque bajo . close coupled . compacte



15 >

CDR . COLOR  
COULEUR

13

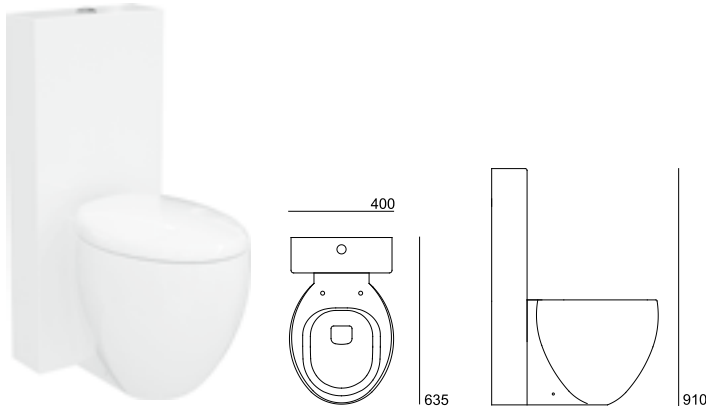

Sanita . Inodoro . Toilet . Toilette  
**39071XX2V**  
**39071XX2H**

Tanque . Cistern . Réservoir  
**39142XX2K**

Tampo . Tapa . Cover . Abattant  
**50264XX5 [SC]**

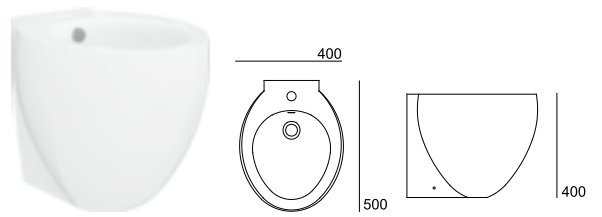

Bidé . Bidet  
**39411XX2K**

< 16

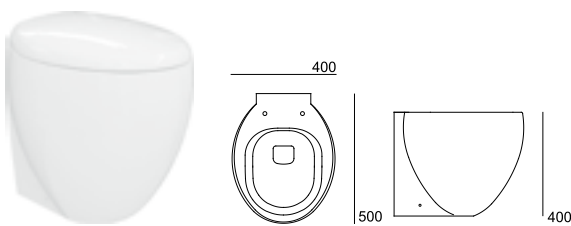

Sanita BTW . Inodoro BTW . BTW Toilet . Toilette BTW  
**39071XX2K [V]**  
**39071XX2W [H]**

Tampo . Tapa . Cover . Abattant  
**50264XX5 [SC]**

Alternativa ao produto apresentado em ambiente .  
 Alternativa al producto presentado en ambiente .  
 Alternative to the product presented in the environment .  
 Alternative au produit présenté dans l'environnement



Banheira . Bañera . Bath tub . Baignoire  
**52100000**

## cores

colores . colors . couleurs

sanitários . sanitarios .  
 sanitary ware . toilettes



torneiras . griferia .  
 taps . robinets



Outras cores sob consulta  
 Otros colores bajo consulta  
 Other colours on request  
 Autres couleurs sur demande

# EGG

compacta . para tanque baixo . close coupled . compacte

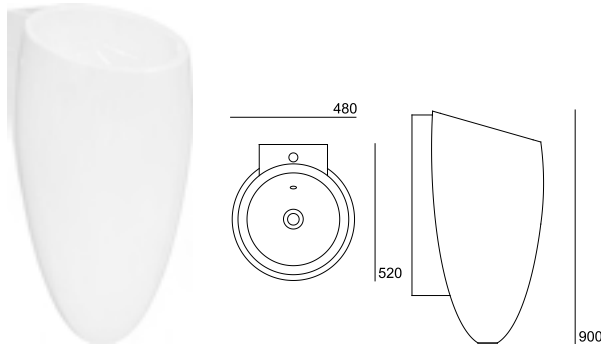

**Lavatório de coluna . Lavabo de columna . Washbasin with pedestal . Lavabo de colonne**  
**39881XX2C**



**Lavatório . Lavabo . Washbasin**  
**39357XX2C**

Alternativa ao produto apresentado em ambiente .  
Alternativa al producto presentado en ambiente .  
Alternative to the product presented in the environment .  
Alternative au produit présenté dans l'environnement

17 >



**Cayenne Lavatório . Lavabo . Washbasin**  
**5061502X**



**Cayenne Bidé . Bidet**  
**5061504X**



**Luna Banheira . Bañera . Bathtub . Baignoire**  
**50621152XX**



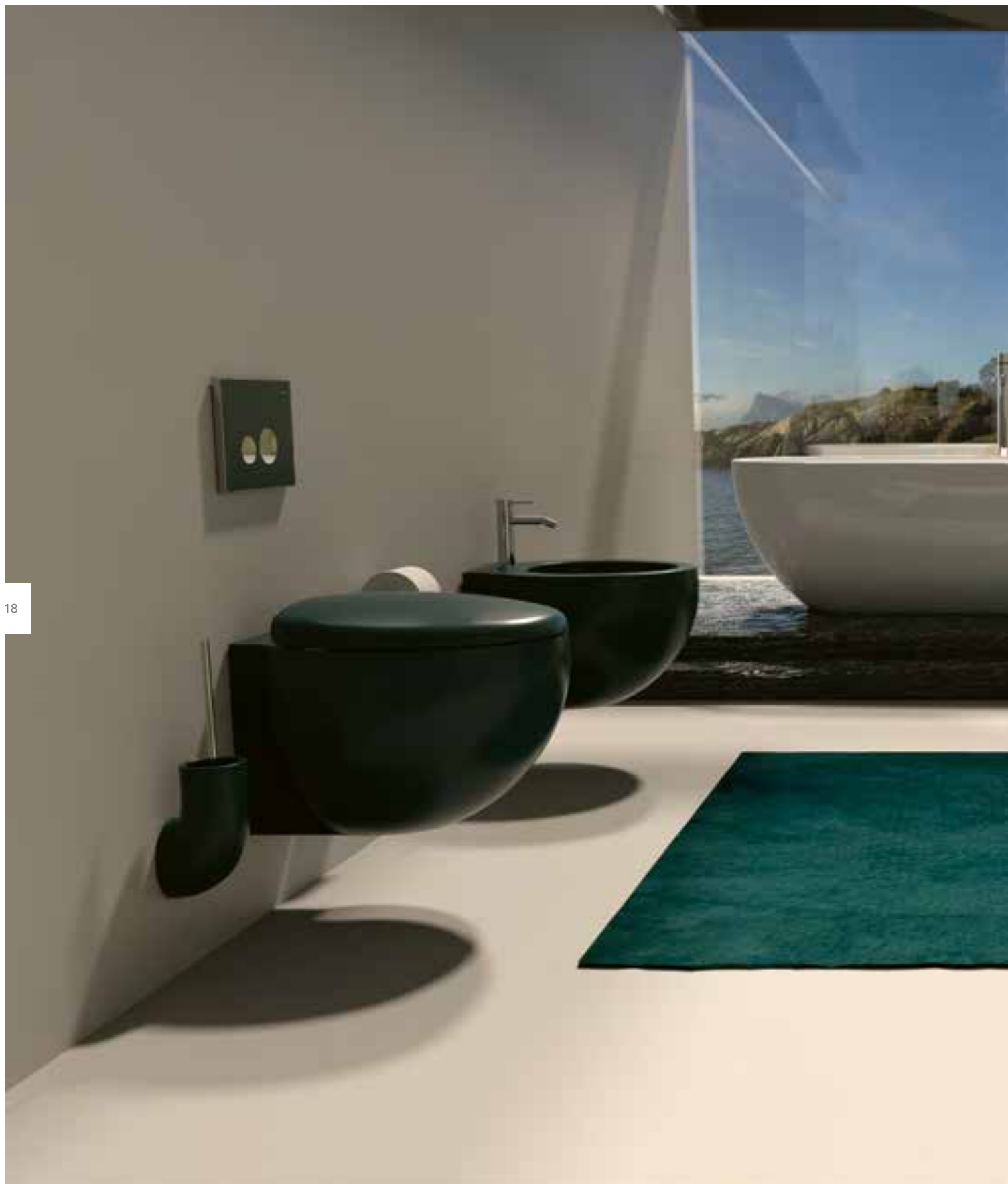

< 18

A nossa EGG, desenhada pela designer de interiores Gracinha Viterbo, que com o seu toque pessoal, conferiu-lhe a sumptuosidade das linhas intemporais circulares. A nossa gama mais exclusiva.

Nuestra colección EGG fue diseñada por la interiorista Gracinha Viterbo, quien con su toque personal ha conseguido transmitir una suntuosidad de líneas intemporales circulares. Es nuestra colección más exclusiva.

Our EGG, designed by the interior designer Gracinha Viterbo, who, with her personal touch, gave it the sumptuousness of the timeless circular lines. Our most exclusive range.

Notre EGG, conçu par l'architecte d'intérieur Gracinha Viterbo, qui, avec sa touche personnelle, lui a donné la somptuosité des lignes circulaires intemporelles. Notre gamme la plus exclusive.

# EGG

suspensa . suspendida . wall hung . suspendue



19 >

CDR . COLOR  
COULEUR

44

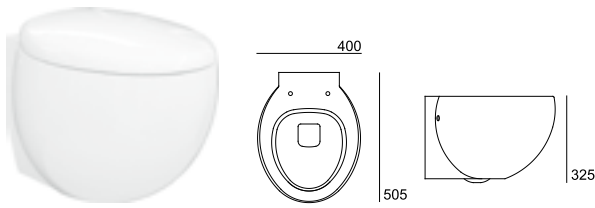

**Sanita . Inodoro . Toilet . Toilette**  
**39001XX2K**

**Tampo . Tapa . Cover . Abattant**  
**50268XX5 [SC]**

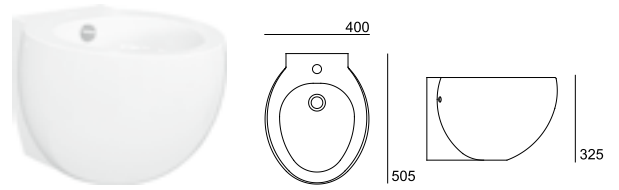

**Bidé . Bidet**  
**39401XX2K**

< 20

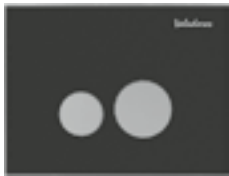

**Tile Placa de comando . Paneles de control .**  
**Command panels . Plaques de commande**  
**55038XXY**

Ver página 97 . See page 97 . Voir page 97

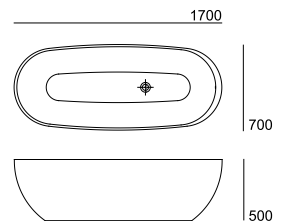

**Banheira . Bañera . Bathtub . Baignoire**  
**52100000**

## cores

colores . colors . couleurs

sanitários . sanitarios .  
sanitary ware . toilettes



torneiras . griferia .  
taps . robinets



**Outras cores sob consulta**  
Otros colores bajo consulta  
Other colours on request  
Autres couleurs sur demande

# EGG

suspensa . suspendida . wall hung . suspendue

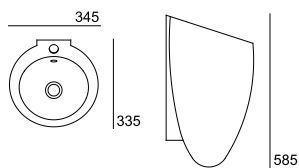

Lavatório . Lavabo . Washbasin  
**39871XX2K**

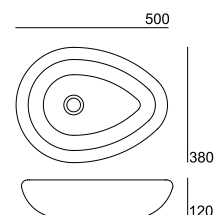

Lavatório . Lavabo . Washbasin  
**39357XX2C**

Alternativa ao produto apresentado em ambiente .  
Alternativa al producto presentado en ambiente .  
Alternative to the product presented in the environment .  
Alternative au produit présenté dans l'environnement

21 >



Cayenne Lavatório .  
Lavabo . Washbasin  
**5061532X**



Cayenne Bidé . Bidet  
**5061504X**



Fidji Banheira . Bañera .  
Bathtub . Baignoire  
**5069525XC**





*Inspirada no molúsculo mais antigo do mundo, existente nas profundezas do oceano pacífico transmite-nos a pureza das linhas elegantes eternizadas num design distinto.*  
*Inspirada en el molusco más antiguo del mundo que habita en las profundidades del océano Pacífico, nos transmite la pureza de las líneas elegantes eternizadas en un diseño distinguido.*  
*Inspired by the oldest mollusk in the world, existing in the depths of the Pacific Ocean, it conveys the purity of elegant lines eternalized in a distinctive design.*  
*Inspiré du plus ancien mollusque du monde, existant dans les profondeurs de l'océan Pacifique, il transmet la pureté de lignes élégantes éternisées dans un design distinctif.*



# NAUTILUS

compacta . para tanque bajo . close coupled . compacte



23 >

COB . COLOR  
COULEUR

00

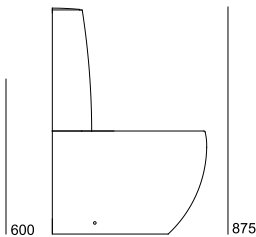
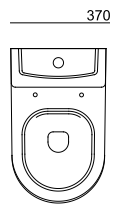

**Sanita . Inodoro . Toilet . Toilette**  
**34554XX2V**  
**34554XX2H**  
**Tanque . Cistern . Réservoir**  
**34192XX2K**  
**Tampo . Tapa . Cover . Abattant**  
**50212XX0 [SC]**  
**50213XX0**

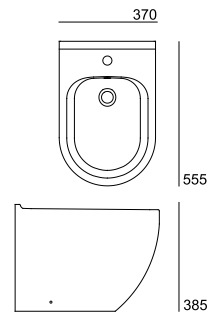

**Bidé . Bidet**  
**34414XX2K**

< 24



**Cayenne Lavatório . Lavabo . Washbasin**  
**5061502X**



**Cayenne Bidé . Bidet**  
**5061504X**

**cores**

colores . colors . couleurs

sanitários . sanitarios .  
 sanitary ware . toilettes



torneiras . griferia .  
 taps . robinets



**Outras cores sob consulta**  
 Otros colores bajo consulta  
 Other colours on request  
 Autres couleurs sur demande

# NAUTILUS

compacta . para tanque baixo . close coupled . compacte

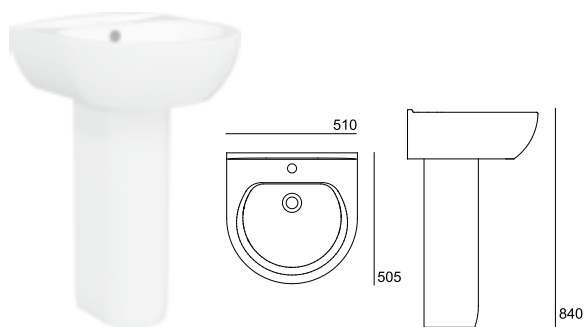

Lavatório . Lavabo . Washbasin  
**34331XX2C**

Coluna . Columna . Pedestal . Colonne  
**34200XX2K**

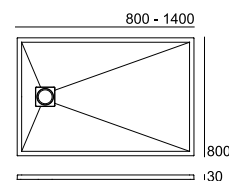
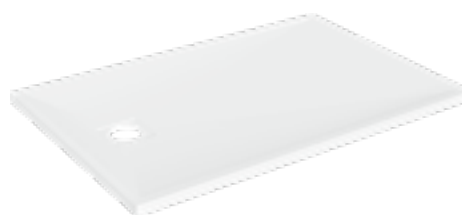

Flow Base chuveiro . Plato de Ducha .  
Shower Tray . Receveur de Douche

- 78686102K** [140x80x3cm]
- 78684102K** [120x80x3cm]
- 78683102K** [110x80x3cm]
- 78682102K** [100x80x3cm]
- 78681102K** [90x80x3cm]
- 78680102K** [80x80x3cm]

25 >



Cayenne Duche . Ducha . Shower . Douche  
**5062557X - 2 Saídas** . Salidas . Ways out . Sorties



Chuveiro . Ducha . Shower . Douche  
**5068308X**





*Inspirada no molúsculo mais antigo do mundo, existente nas profundezas do oceano pacífico transmite-nos a pureza das linhas elegantes eternizadas num design distinto.*  
*Inspirada en el molusco más antiguo del mundo que habita en las profundidades del océano Pacífico, nos transmite la pureza de las líneas elegantes eternizadas en un diseño distinguido.*  
*Inspired by the oldest mollusk in the world, existing in the depths of the Pacific Ocean, it conveys the purity of elegant lines eternalized in a distinctive design.*  
*Inspiré du plus ancien mollusque du monde, existant dans les profondeurs de l'océan Pacifique, il transmet la pureté de lignes élégantes éternisées dans un design distinctif.*

# NAUTILUS

suspensa . suspendida . wall hung . suspendue



27 >

COI . COLOR  
COULEUR

15

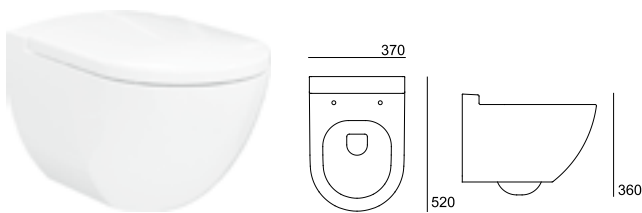

**Sanita . Inodoro . Toilet . Toilette**  
**34504XX2K [RIMLESS]**  
**34004XX2K**  
**Tampo . Tapa . Cover . Abattant**  
**50239XX0 [SC]**  
**50235XX0**

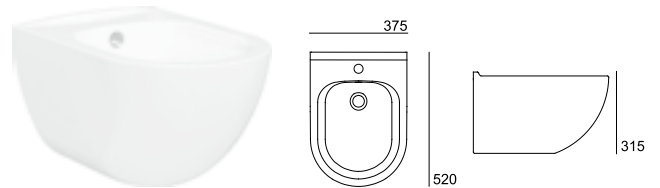

**Bidé . Bidet**  
**34404XX2K**

< 28



**Plat2 Placa de comando . Paneles de control .**  
**Command panels . Plaques de commande**  
**5503421X**

Ver página 97 . See page 97 . Voir page 97

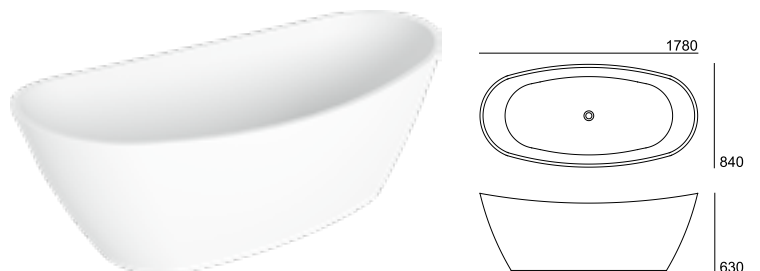

**Star Banheira . Bañera . Bathtub . Baignoire**  
**51100201**

## cores

colores . colors . couleurs

sanitários . sanitarios .  
 sanitary ware . toilettes



torneiras . griferia .  
 taps . robinets



**Outras cores sob consulta**  
 Otros colores bajo consulta  
 Other colours on request  
 Autres couleurs sur demande

# NAUTILUS

suspensa . suspendida . wall hung . suspendue

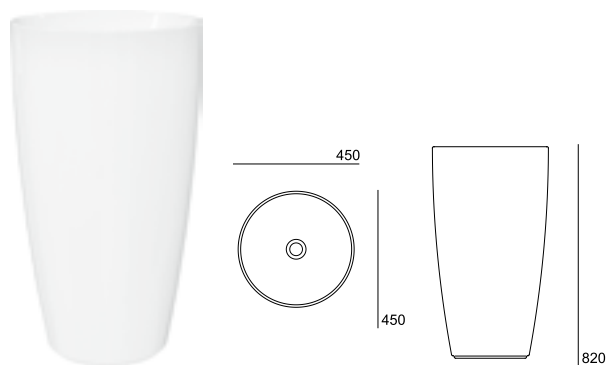

**Kobe Lavatório . Lavabo . Washbasin**  
**79910XX2C** - com saída inferior . con salida inferior .  
 with bottom outlet . avec sortie inférieure  
**79911XX2C** - com saída lateral . con salida lateral .  
 with side outlet . avec sortie latérale

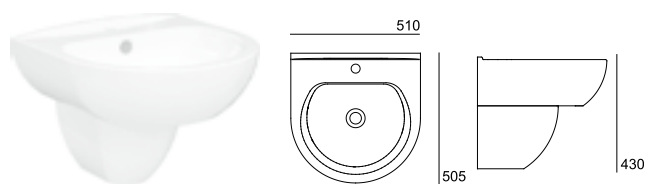

**Lavatório . Lavabo . Washbasin**  
**34331XX2C**  
**Coluna . Columna . Pedestal . Colonne**  
**34220XX2K**

Alternativa ao produto apresentado em ambiente .  
 Alternativa al producto presentado en ambiente .  
 Alternative to the product presented in the environment .  
 Alternative au produit présenté dans l'environnement

29 >



**Fidji Lavatório mural . Lavabo mural .**  
 Wall mounted washbasin . Lavabo au mur  
**5069582XC**



**Fidji Bidé . Bidet**  
**5069504X**



**Fidji Banheira . Bañera .**  
 Bathtub . Baignoire  
**5069525XC**





*O equilíbrio entre a estética e o design, foi a primeira série desenvolvida pela ARCH. Abrindo caminho à mostra do que seria a nova Valadares.*

*El equilibrio entre la estética y el diseño. Fue la primera colección desarrollada por ARCH lo que abrió el camino para demostrar en lo que se convertiría la nueva Valadares.*

*The balance between aesthetics and design was the first series developed by ARCH. Opening the way to show what the new Valadares would be.*

*L'équilibre entre esthétique et design a été la première série développée par ARCH. Ouvrant la voie pour montrer ce que seraient la nouvelle Valadares.*



# ONE

compacta . para tanque bajo . close coupled . compacte

31 >

CDR . COLOR  
COULEUR

00

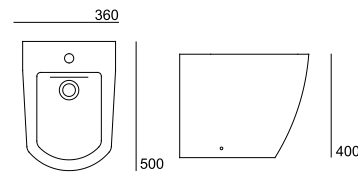
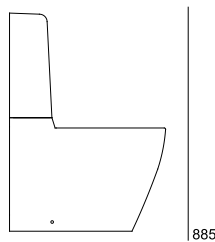
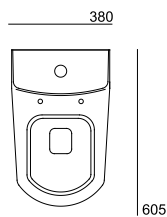

Sanita . Inodoro . Toilet . Toilette  
**40051XX2V**  
**40051XX2H**

Bidé . Bidet  
**40411XX2K**

Tanque . Cistern . Réservoir  
**40182XX2K**

Tampo . Tapa . Cover . Abattant  
**50202XX0 [SC]**  
**50203XX0**

< 32



Line Lavatório . Lavabo . Washbasin  
**5061302X**



Line Bidé . Bidet  
**5061304X**



Line Banheira . Bañera .  
 Bathtub . Baignoire  
**5061315X**

## cores

colores . colors . couleurs

sanitários . sanitarios .  
 sanitary ware . toilettes

xx=

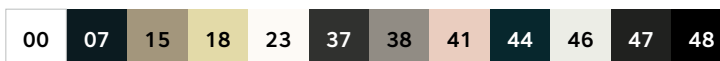

torneiras . griferia .  
 taps . robinets

x=

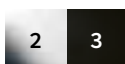

Outras cores sob consulta  
 Otros colores bajo consulta  
 Other colours on request  
 Autres couleurs sur demande

# ONE

compacta . para tanque bajo . close coupled . compacte

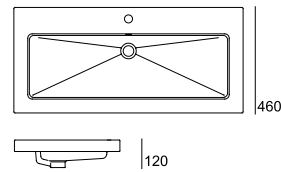

**Rafael Lavatório . Lavabo . Washbasin**  
**79831XX2C** [120x46x12cm]  
**79821XX2C** [100x46x12cm]  
**79811XX2C** [80x46x12cm]  
**79801XX2C** [60x46x12cm]  
**79861XX2C** [50x46x12cm]

33 >

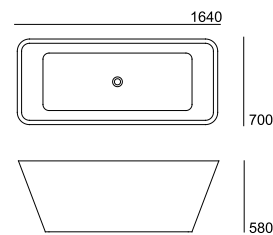

**Lux Banheira . Bañera . Bathtub . Baignoire**  
**51100202**





< 34

*O equilíbrio entre a estética e o design, foi a primeira série desenvolvida pela ARCH. Abrindo caminho à mostra do que seria a nova Valadares.*

*El equilibrio entre la estética y el diseño. Fue la primera colección desarrollada por ARCH lo que abrió el camino para demostrar en lo que se convertiría la nueva Valadares.*

*The balance between aesthetics and design was the first series developed by ARCH. Opening the way to show what the new Valadares would be.*

*L'équilibre entre esthétique et design a été la première série développée par ARCH. Ouvrant la voie pour montrer ce que seraient la nouvelle Valadares.*

# ONE

suspensa . suspendida . wall hung . suspendue



35 >

COPR. COLOR  
COULEUR

15



**Sanita . Inodoro . Toilet . Toilette**  
**40001XX2K**  
**Tampo . Tapa . Cover . Abattant**  
**50202XX0 [SC]**  
**50203XX0**

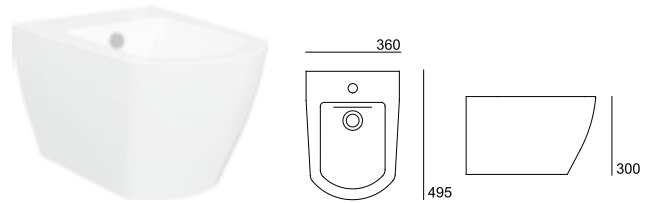

**Bidé . Bidet**  
**40401XX2K**

< 36



**Square Placa de comando .**  
*Paneles de control . Command panels .*  
*Plaques de commande*  
**5503430X**

Ver página 97 . See page 97 . Voir page 97



**Cayenne Lavatório .**  
*Lavabo . Washbasin*  
**5061512X**



**Cayenne Bidé . Bidet**  
**5061504X**

## cores

colores . colors . couleurs

sanitários . sanitarios .  
 sanitary ware . toilettes



torneiras . griferia .  
 taps . robinets



**Outras cores sob consulta**  
*Otros colores bajo consulta*  
*Other colours on request*  
*Autres couleurs sur demande*

# ONE

suspensa . suspendida . wall hung . suspendue



**One Slim Lavatório . Lavabo . Washbasin**  
**40357XX2C**



**Pádua Base chuveiro . Plato de Ducha . Shower Tray . Receveur de Douche**  
**78636002K** [120x80x5cm]  
**78635002K** [100x80x5cm]



**Lotto Duche . Ducha . Shower . Douche**  
**5066247X**

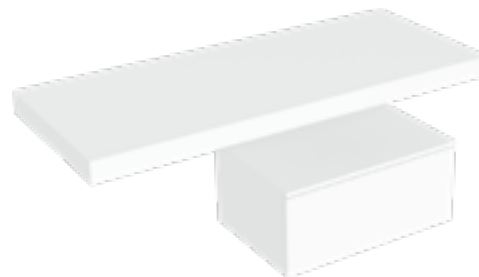

**Table**

Ver página 137 . See page 137 . Voir page 137

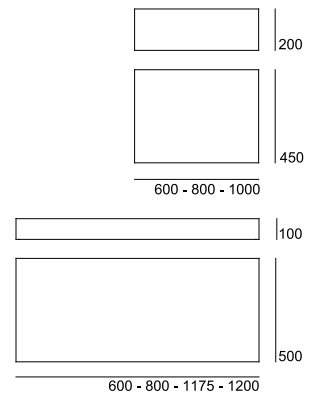

37 >





*Conferindo tecnologia, design e inovação, a série TWO reforça a simplicidade, conforto e comodidade nas suas linhas.  
La colección TWO refuerza la sencillez, bienestar y comodidad en sus líneas a través de la tecnología, diseño e innovación.  
Offering technology, design and innovation, the TWO series reinforces simplicity, comfort and convenience in its lines.  
Offrant technologie, design et innovation, la série TWO renforce la simplicité, le confort et la commodité dans ses lignes.*



# TWO

compacta . para tanque bajo . close coupled . compacte



39 >

COB . COLOR  
COULEUR

23

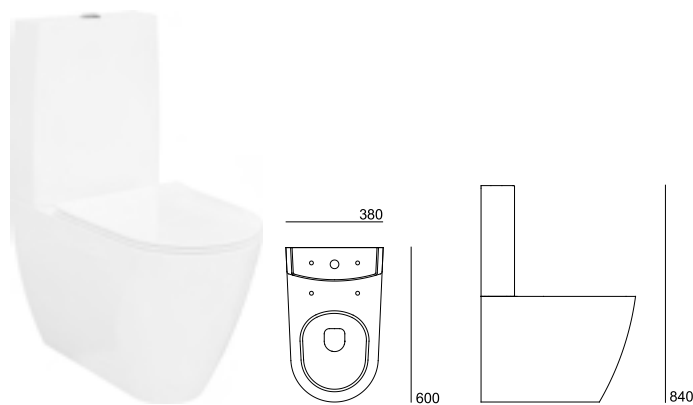

Sanita . Inodoro . Toilet . Toilette  
**41051XX2V**  
**41051XX2H**

Tanque . Cistern . Réservoir  
**41182XX2K**

Tampo . Tapa . Cover . Abattant  
**50204XX0 [SLIM SC]**  
**50205XX0 [SLIM]**  
**50210XX0 [SC]**  
**50211XX0**

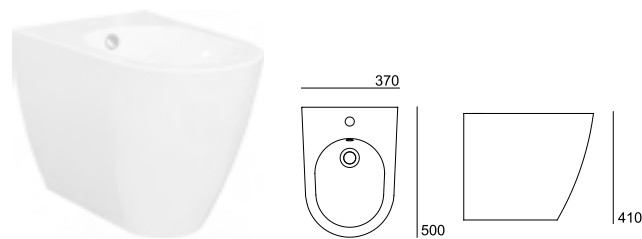

Bidé . Bidet  
**41411XX2K**

< 40



Lotto Lavatório mural . Lavabo mural .  
 Wall mounted washbasin . Lavabo au mur  
**5066222X**



Lotto Bidé . Bidet  
**5066204X**

## cores

colores . colors . couleurs

sanitários . sanitarios .  
 sanitary ware . toilettes

xx=



torneiras . griferia .  
 taps . robinets

x=

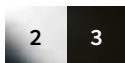

**Outras cores sob consulta**  
 Otros colores bajo consulta  
 Other colours on request  
 Autres couleurs sur demande

# TWO

compacta . para tanque baixo . close coupled . compacte

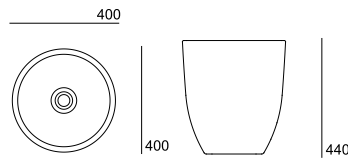

**Rubens Lavatório . Lavabo . Washbasin**  
**79900XX2C**

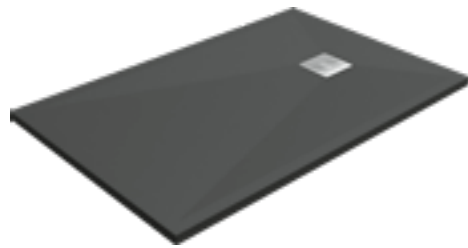

**Iko Slate**

Disponível em vários tamanhos (consultar tabela de preços) .  
Disponible en varios tamaños (ver tarifa de precios) .  
Available in various sizes (see prices list) .  
Disponible en différentes tailles (voir liste de prix)

Ver página 201 . See page 201 . Voir page 201

41 >



**Chuveiro . Ducha . Shower . Douche**  
**5068313X**



**Lotto Duche mural . Ducha mural .**  
**Wall mounted Shower . Douche murale**  
**5066207X**





*Conferindo tecnologia, design e inovação, a série TWO reforça a simplicidade, conforto e comodidade nas suas linhas.  
La colección TWO refuerza la sencillez, bienestar y comodidad en sus líneas a través de la tecnología, diseño e innovación.  
Offering technology, design and innovation, the TWO series reinforces simplicity, comfort and convenience in its lines.  
Offrant technologie, design et innovation, la série TWO renforce la simplicité, le confort et la commodité dans ses lignes.*

# TWO

BTW Rimless



43 >

CON. COLOR  
COLLETTA

47

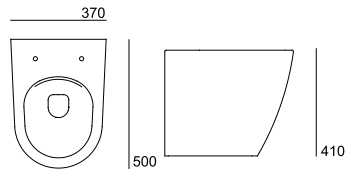

Sanita . Inodoro . Toilet . Toilette  
**41541XX2V**  
**41541XX2H**

Tampo . Tapa . Cover . Abattant  
**50204XX0 [SLIM SC]**  
**50205XX0 [SLIM]**  
**50210XX0 [SC]**  
**50211XX0**

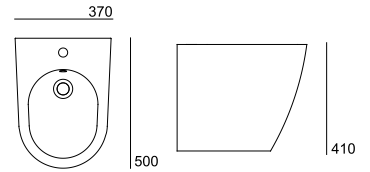

Bidé . Bidet  
**41411XX2K**

< 44



Tile Placa de comando .  
 Paneles de control .  
 Command panels .  
 Plaques de commande  
**55038XXY**

Ver página 97 . See page 97 . Voir page 97



Lotto Lavatório mural . Lavabo mural .  
 Wall mounted washbasin . Lavabo au mur  
**5066222X**



Lotto Bidé . Bidet  
**5066204X**

## cores

colores . colors . couleurs

sanitários . sanitarios .  
 sanitary ware . toilettes

xx=



torneiras . griferia .  
 taps . robinets

x=

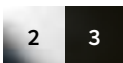

Outras cores sob consulta  
 Otros colores bajo consulta  
 Other colours on request  
 Autres couleurs sur demande

# TWO

BTW Rimless

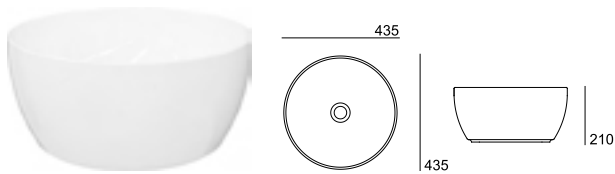

**Zen Lavatório** . *Lavabo . Washbasin*  
**79920XX2C**



**Pádua Base chuveiro** . *Plato de Ducha . Shower Tray . Receveur de Douche*  
**78636002K** [120x80x5cm]  
**78635002K** [100x80x5cm]

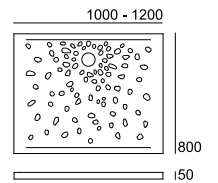

**Lotto Duche** . *Ducha . Shower . Douche*  
**5066247X**



**Lis Estrutura** . *Estructura . Frame . Structure*  
**5287X123** [120x50cm]  
**5287X103** [100x50cm]  
**5287X083** [80x50cm]

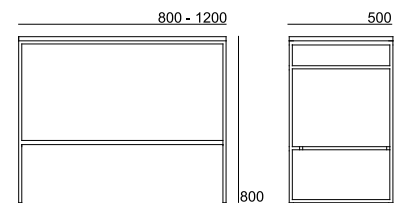

Ver página 132 . See page 132 . Voir page 132

45 >





< 46

*Conferindo tecnologia, design e inovação, a série TWO reforça a simplicidade, conforto e comodidade nas suas linhas.  
La colección TWO refuerza la sencillez, bienestar y comodidad en sus líneas a través de la tecnología, diseño e innovación.  
Offering technology, design and innovation, the TWO series reinforces simplicity, comfort and convenience in its lines.  
Offrant technologie, design et innovation, la série TWO renforce la simplicité, le confort et la commodité dans ses lignes.*



# TWO

suspensa . suspendida . wall hung . suspendue



47 >

COB . COLOR  
COULEUR

00

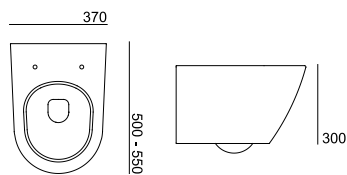

**Sanita . Inodoro . Toilet . Toilette**  
**41505XX2K [RIMLESS 55]**  
**41502XX2K [RIMLESS]**  
**41001XX2K**

**Tampo . Tapa . Cover . Abattant**  
**50204XX0 [SLIM SC]**  
**50205XX0 [SLIM]**  
**50210XX0 [SC]**  
**50211XX0**

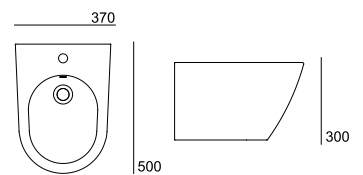

**Bidé . Bidet**  
**41401XX2K**

< 48

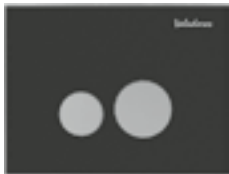

**Tile Placa de comando . Paneles de control . Command panels . Plaques de commande**  
**55038XXY**

Ver página 97 . See page 97 . Voir page 97



**Cayenne Lavatório . Lavabo . Washbasin**  
**5061512X**



**Cayenne Bidé . Bidet**  
**5061504X**

## cores

colores . colors . couleurs

sanitários . sanitarios . sanitary ware . toilettes

xx= 

|    |    |    |    |
|----|----|----|----|
| 00 | 23 | 47 | 48 |
|----|----|----|----|

torneiras . griferia . taps . robinets

x= 

|   |   |   |
|---|---|---|
| 2 | 3 | 0 |
|---|---|---|

**Outras cores sob consulta**  
 Otros colores bajo consulta  
 Other colours on request  
 Autres couleurs sur demande

# TWO

suspensa . suspendida . wall hung . suspendue

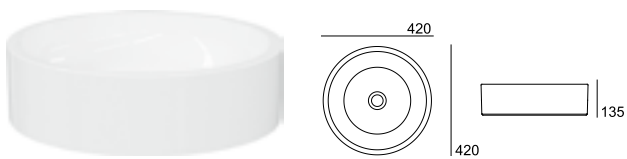

**Malibu Lavatório . Lavabo . Washbasin**  
**78737XX2C**



**Flow Base chuveiro . Plato de Ducha . Shower Tray . Receveur de Douche**

- 78686102K** [140x80x3cm]
- 78684102K** [120x80x3cm]
- 78683102K** [110x80x3cm]
- 78682102K** [100x80x3cm]
- 78681102K** [90x80x3cm]
- 78680102K** [80x80x3cm]

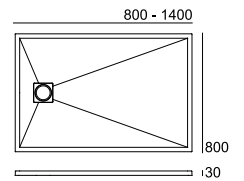

49 >



**Cayenne Duche . Ducha . Shower . Douche**  
**5062557X - 2 Saídas .**  
Salidas . Ways out . Sorties

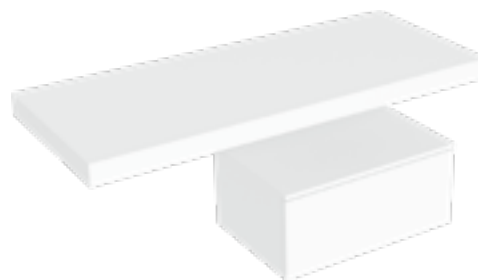

**Table Móvel**

Ver página 137 . See page 137 . Voir page 137

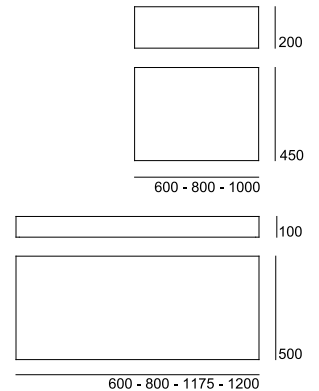



< 50

*Desenhada pelo Arqu. Luis Rebelo de andrade, confere a leveza que o seu nome indica. A série que demarca a bipolaridade perfeita entre cores.*

*Una colección diseñada por el arquitecto Luis Rebelo de Andrade que representa la levedad que su nombre indica. Esta serie se destaca por el binómio perfecto entre los colores.*

*Designed by the architect Luis Rebelo de Andrade, it provides the lightness that its name indicates. The series that marks the perfect bipolarity between colors.*

*Conçu par l'architecte Luis Rebelo de Andrade, confère la légèreté que son nom indique. La série qui marque la bipolarité parfaite entre les couleurs.*

# LIGHT

suspensa . suspendida . wall hung . suspendue



51 >

CON . COLOR  
COULEUR  
98



Sanita . Inodoro . Toilet . Toilette  
**36001XX2K**

Tampo . Tapa . Cover . Abattant  
**50243XX0 [CM SC]**  
**50242XX0 [CM]**



Bidé . Bidet  
**36401XX2K**

< 52



Tile Placa de comando . Paneles de control .  
Command panels . Plaques de commande  
**55038XXY**

Ver página 97 . See page 97 . Voir page 97

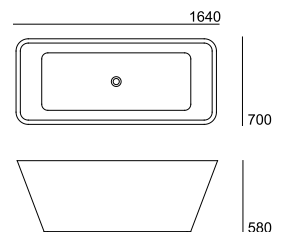

Lux Banheira . Bañera . Bathtub . Baignoire  
**51100202**

## cores

colores . colors . couleurs

sanitários . sanitarios .  
sanitary ware . toilettes



torneiras . griferia .  
taps . robinets

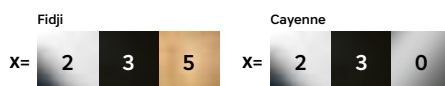

**Outras cores sob consulta**  
Otros colores bajo consulta  
Other colours on request  
Autres couleurs sur demande

# LIGHT

suspensa . suspendida . wall hung . suspendue



Lavatório . Lavabo . Washbasin  
**36331XX2C**

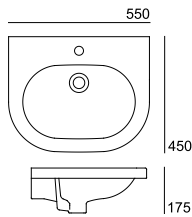

Cayenne Lavatório . Lavabo . Washbasin  
**5061502X**

53 >



Cayenne Bidé . Bidet  
**5061504X**



Fidji Banheira . Bañera . Bathtub  
**5069525XC**





*Representativa de mais de 100 anos de história em Tecnologia, inovação, fabricação e comercialização de produtos cerâmicos, a nossa Série Neoclassica é um ícone que nos distingue.*

*Símbolo de más de 100 años de historia tecnológica, innovación, fabricación y comercialización de productos cerámicos. Nuestra colección Neoclassica es un ícono que nos distingue.*

*Representative of more than 100 years of history in technology, innovation, manufacturing and commercialization of ceramic products, our Neoclassica Series is an icon that distinguishes us.*

*Représentant plus de 100 ans d'histoire dans la technologie, l'innovation, la fabrication et la commercialisation de produits céramiques, notre série Neoclassica est un icône qui nous distingue.*



# NEOCLÁSSICA

compacta . para tanque bajo . close coupled . compacte



55 >

COB . COLOR  
COULEUR

00



Sanita . Inodoro . Toilet . Toilette  
**16024XX2K [V]**  
**16021XX2K [H]**

Tanque . Cistern . Réservoir  
**16163XX2K [↓]**  
**16161XX2K [→]**

Tampo . Tapa . Cover . Abattant  
**50376XX0 [CM SC]**  
**50343XX0 [CM]**

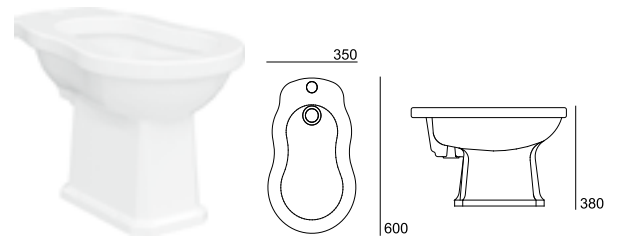

Bidé . Bidet  
**16411XX2K**

< 56



Classic Banheira . Bañera .  
 Bathtub . Baignoire  
**5063515X**



Classic banheira . Bañera . Bathtub . Baignoire  
**51100002** [175x82cm]  
**51100001** [168x76cm]

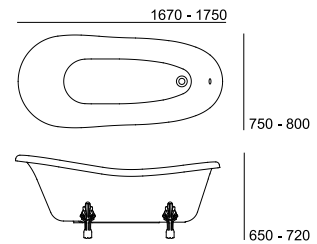

## cores

colores . colors . couleurs

sanitários . sanitarios .  
 sanitary ware . toilettes

xx= 

|    |    |    |    |    |    |
|----|----|----|----|----|----|
| 00 | 07 | 20 | 23 | 47 | 48 |
|----|----|----|----|----|----|

torneiras . griferia .  
 taps . robinets

x= 

|   |   |   |
|---|---|---|
| 2 | 4 | 5 |
|---|---|---|

**Outras cores sob consulta**  
 Otros colores bajo consulta  
 Other colours on request  
 Autres couleurs sur demande

# NEOCLÁSSICA

compacta . para tanque bajo . close coupled . compacte

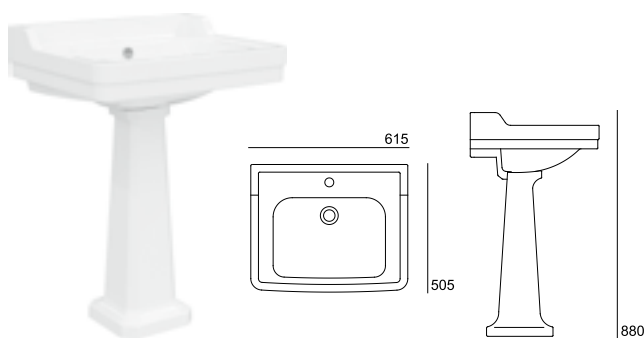

**Lavatório médio c/ espaldar .**  
*Lavabo médio con espaldar .*  
*Washbasin medium w/ back splash .*  
*Lavabo moyen avec dossier .*  
**16351XX2C**

**Coluna . Columna . Pedestal . Colonne**  
**16200XX2K**

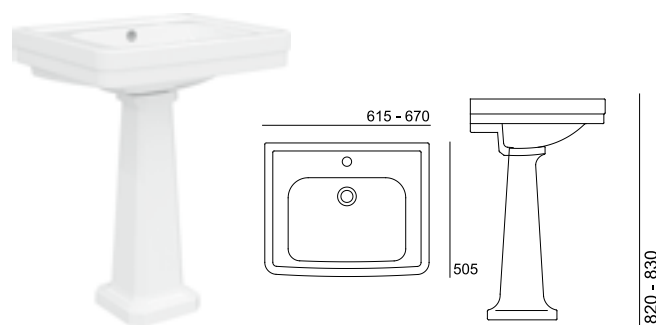

**Lavatório . Lavabo . Washbasin**  
**16321XX2C** [67x50x23cm]  
**16331XX2C** [61x50x23cm]

**Coluna . Columna . Pedestal . Colonne**  
**16200XX2K**

**Alternativa ao produto apresentado em ambiente .**  
*Alternativa al producto presentado en ambiente .*  
*Alternative to the product presented in the environment .*  
*Alternative au produit présenté dans l'environnement*

57 >



**Classic Lavatório .**  
*Lavabo . Washbasin*  
**5063502X**



**Classic Bidé . Bidet**  
**5063504X**

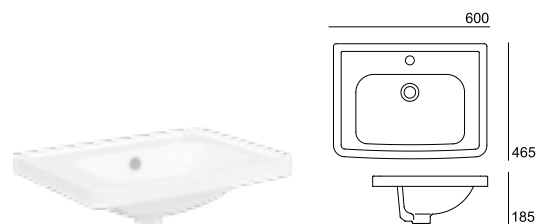

**Lavatório . Lavabo . Washbasin**  
**16381XX2C**

**Alternativa ao produto apresentado em ambiente .**  
*Alternativa al producto presentado en ambiente .*  
*Alternative to the product presented in the environment .*  
*Alternative au produit présenté dans l'environnement*

**Ver estrutura página 137 . Ver estructura en la página 137 .**  
*See structure page 137 . Voir la structure à la page 137*





< 58

*Representativa de mais de 100 anos de história em Tecnologia, inovação, fabricação e comercialização de produtos cerâmicos, a nossa Série Neoclassica é um ícone que nos distingue.*

*Símbolo de más de 100 años de história tecnológica, innovación, fabricación y comercialización de productos cerámicos. Nuestra colección Neoclassica es un ícono que nos distingue.*

*Representative of more than 100 years of history in technology, innovation, manufacturing and commercialization of ceramic products, our Neoclassica Series is an icon that distinguishes us.*

*Représentant plus de 100 ans d'histoire dans la technologie, l'innovation, la fabrication et la commercialisation de produits céramiques, notre série Neoclassica est une icône qui nous distingue.*

# NEOCLÁSSICA

normal

59 >

001 COLOR  
001111

00

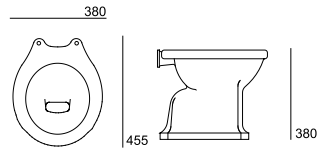

Sanita . Inodoro . Toilet . Toilette  
**16014XXK [V]**  
**16011XXK [H]**

Tanque . Cistern . Réservoir

**16131XX2K** [Alto . High level . Haut niveau]

**16163XX2SK** [↓]

**16161XX2SK** [→]

Tampo . Tapa . Cover . Abattant

**50377XX0 [CM SC]**

**50344XX0 [CM]**

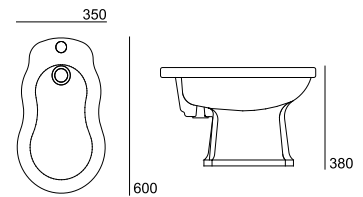

Bidé . Bidet  
**16411XX2K**

< 60



Classic Banheira . Bañera .  
 Bathtub . Baignoire  
**5063515X**



Classic banheira . Bañera . Bathtub . Baignoire  
**51100002** [175x82cm]  
**51100001** [168x76cm]

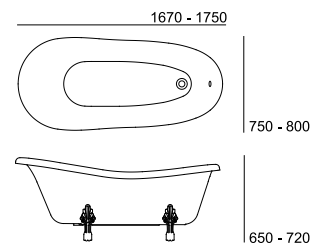

## cores

colores . colors . couleurs

sanitários . sanitarios .  
 sanitary ware . toilettes

xx= 

|    |    |    |    |    |    |
|----|----|----|----|----|----|
| 00 | 07 | 20 | 23 | 47 | 48 |
|----|----|----|----|----|----|

torneiras . griferia .  
 taps . robinets

x= 

|   |   |   |
|---|---|---|
| 2 | 4 | 5 |
|---|---|---|

**Outras cores sob consulta**  
 Otros colores bajo consulta  
 Other colours on request  
 Autres couleurs sur demande

# NEOCLÁSSICA

normal

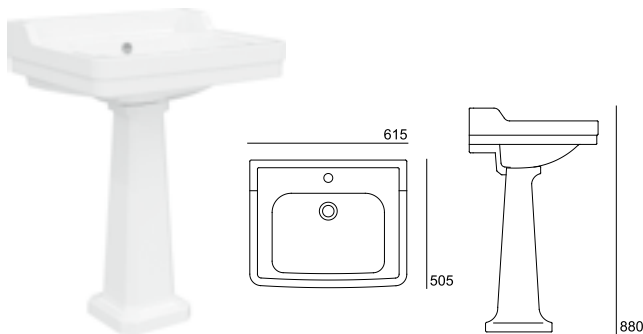

**Lavatório médio c/ espaldar .**  
*Lavabo médio con espaldar .*  
*Washbasin medium w/ back splash .*  
*Lavabo moyen avec dossier .*  
**16351XX2C**  
**Coluna . Columna . Pedestal . Colonne**  
**16200XX2K**

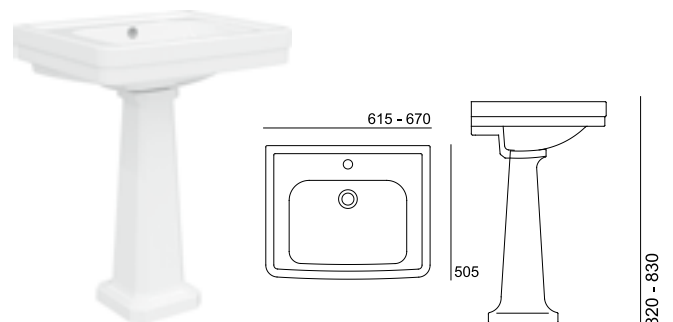

**Lavatório . Lavabo . Washbasin**  
**16321XX2C** [67x50x23cm]  
**16331XX2C** [61x50x23cm]  
**Coluna . Columna . Pedestal . Colonne**  
**16200XX2K**

**Alternativa ao produto apresentado em ambiente .**  
*Alternativa al producto presentado en ambiente .*  
*Alternative to the product presented in the environment .*  
*Alternative au produit présenté dans l'environnement*

61 >



**Classic Lavatório .**  
*Lavabo . Washbasin*  
**5063502X**



**Classic Bidé . Bidet**  
**5063504X**

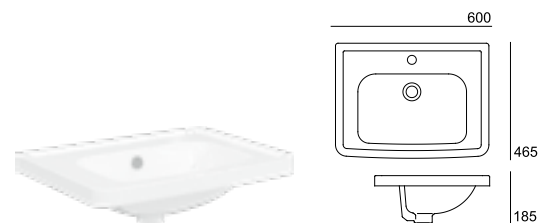

**Lavatório . Lavabo . Washbasin**  
**16381XX2C**

**Alternativa ao produto apresentado em ambiente .**  
*Alternativa al producto presentado en ambiente .*  
*Alternative to the product presented in the environment .*  
*Alternative au produit présenté dans l'environnement*

**Ver estrutura página 137 . Ver estructura en la página 137 .**  
*See structure page 137 . Voir la structure à la page 137*





*Representativa de mais de 100 anos de história em Tecnologia, inovação, fabricação e comercialização de produtos cerâmicos, a nossa Série Neoclassica é um ícone que nos distingue.*

*Símbolo de más de 100 años de historia tecnológica, innovación, fabricación y comercialización de productos cerámicos. Nuestra colección Neoclassica es un ícono que nos distingue.*

*Representative of more than 100 years of history in technology, innovation, manufacturing and commercialization of ceramic products, our Neoclassica Series is an icon that distinguishes us.*

*Représentant plus de 100 ans d'histoire dans la technologie, l'innovation, la fabrication et la commercialisation de produits céramiques, notre série Neoclassica est une icône qui nous distingue.*



# NEOCLÁSSICA

BTW



63 >

COB - COLOR  
COULEUR

00

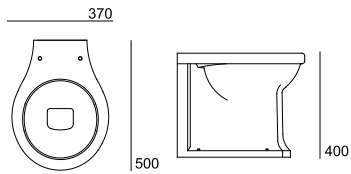

**Sanita . Inodoro . Toilet . Toilette**  
**16041XX2K**

**Tampo . Tapa . Cover . Abattant**  
**50376XX0 [CM SC]**  
**50343XX0 [SC]**

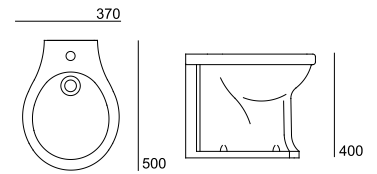

**Bidé . Bidet**  
**16441XX2K**

< 64



**Tile Placa de comando . Paneles de control . Command panels . Plaques de commande**  
**55038XXY**

Ver página 97 . See page 97 . Voir page 97



**Luna Lavatório . Lavabo . Washbasin**  
**50621322XX**



**Luna Bidé . Bidet**  
**50621042XX**

## cores

colores . colors . couleurs

sanitários . sanitarios . sanitary ware . toilettes

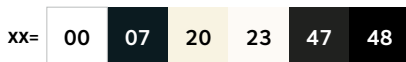

torneiras . griferia . taps . robinets



**Outras cores sob consulta**  
Otros colores bajo consulta  
Other colours on request  
Autres couleurs sur demande

# NEOCLÁSSICA

BTW



**Apoio Lavatório . Lavabo . Washbasin**  
**78331XX2C** [120x55x25cm]  
**78321XX2C** [100x55x25cm]  
**78311XX2C** [80x55x25cm]

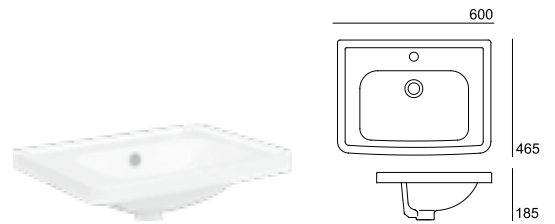
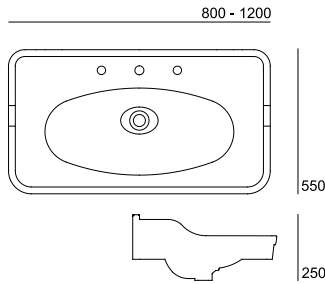

**Lavatório . Lavabo . Washbasin**  
**16381XX2C**

**Alternativa ao produto apresentado em ambiente .**  
*Alternativa al producto presentado en ambiente .*  
*Alternative to the product presented in the environment .*  
*Alternative au produit présenté dans l'environnement*

**Ver estrutura página 137 . Ver estructura en la página 137 .**  
*See structure page 137 . Voir la structure à la page 137*

65 >



**Estrutura p/ Apolo . Estructura p/ Apolo .**  
**Console f/ Apolo . Structure p/ Apolo**  
**507000YX**

**Ver estrutura página 134 . Ver estructura en la página 134 .**  
*See structure page 134 . Voir la structure à la page 134*



**Lavatório . Lavabo . Washbasin**  
**16321XX2C** [67x50x23cm]  
**16331XX2C** [61x50x23cm]

**Coluna . Columna . Pedestal . Colonne**  
**16200XX2K**

**Alternativa ao produto apresentado em ambiente .**  
*Alternativa al producto presentado en ambiente .*  
*Alternative to the product presented in the environment .*  
*Alternative au produit présenté dans l'environnement*

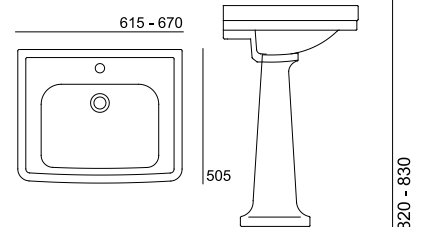



< 66

*Representativa de mais de 100 anos de história em Tecnologia, inovação, fabricação e comercialização de produtos cerâmicos, a nossa Série Neoclassica é um ícone que nos distingue.*

*Símbolo de más de 100 años de historia tecnológica, innovación, fabricación y comercialización de productos cerámicos. Nuestra colección Neoclassica es un ícono que nos distingue.*

*Representative of more than 100 years of history in technology, innovation, manufacturing and commercialization of ceramic products, our Neoclassica Series is an icon that distinguishes us.*

*Représentant plus de 100 ans d'histoire dans la technologie, l'innovation, la fabrication et la commercialisation de produits céramiques, notre série Neoclassica est un icône qui nous distingue.*

# NEOCLÁSSICA

suspensa . suspendida . wall hung . suspendue



67 >

COI, COLOR  
COULEUR

20

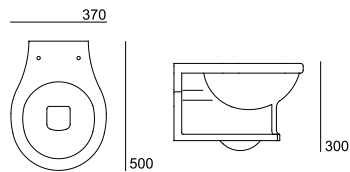

**Sanita . Inodoro . Toilet . Toilette**  
**16001XX2K**

**Tampo . Tapa . Cover . Abattant**  
**50376XX0 [CM SC]**  
**50343XX0 [CM]**

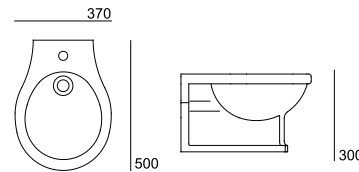

**Bidé . Bidet**  
**16401XX2K**

< 68

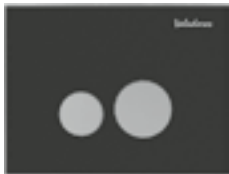

**Tile Placa de comando . Paneles de control . Command panels . Plaques de commande**  
**55038XXY**

Ver página 97 . See page 97 . Voir page 97



**Classic Lavatório . Lavabo . Washbasin**  
**5063502X**

## cores

colores . colors . couleurs

sanitários . sanitarios . sanitary ware . toilettes

xx=



torneiras . griferia . taps . robinets

x=



**Outras cores sob consulta**  
Otros colores bajo consulta  
Other colours on request  
Autres couleurs sur demande

# NEOCLÁSSICA

suspensa . suspendida . wall hung . suspendue

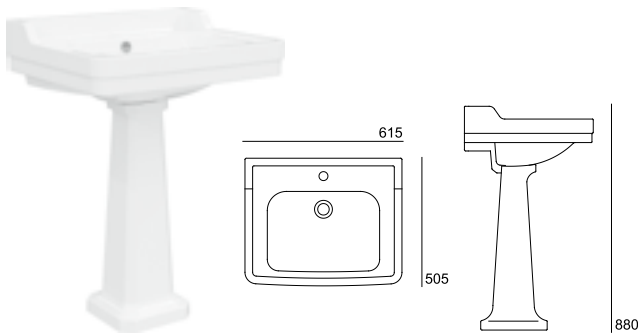

**Lavatório médio c/ espaldar .**

*Lavabo médio con espaldar .*

*Washbasin medium w/ back splash .*

*Lavabo moyen avec dossier .*

**16351XX2C**

**Coluna . Columna . Pedestal . Colonne**

**16200XX2K**

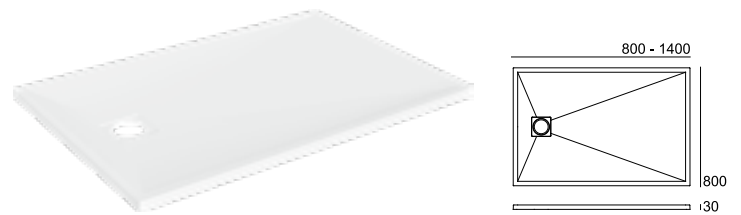

**Flow Base chuveiro . Plato de Ducha .**

*Shower Tray . Receveur de Douche*

**78686102K** [140x80x3cm]

**78684102K** [120x80x3cm]

**78683102K** [110x80x3cm]

**78682102K** [100x80x3cm]

**78681102K** [90x80x3cm]

**78680102K** [80x80x3cm]

69 >



**Classic Bidé . Bidet**

**5063504X**



**Classic Duche mural . Ducha mural .**

*Wall mounted Shower . Douche murale*

**5063507X - 1 Saída .**

*Salida . Way out . Sortie*



**Chuveiro . Ducha . Shower . Douche**

**5068308X**





< 70

*As linhas simples e delicadas, traduzem a leveza de uma marca. Esta é a série que representa um centenário. Este é o orgulho de um legado.  
Las líneas sencillas y dedicadas traducen la levedad de una marca. Esta colección representa un centenário. Es el orgullo de un legado.  
The simple and delicate lines translate the lightness of a brand. This is the series that represents a centenary. This is the pride of a legacy.  
Les lignes simples et délicates traduisent la légèreté d'une marque. C'est la série qui représente un centenaire. C'est la fierté d'un héritage.*



# 100

compacta . para tanque bajo . close coupled . compacte



71 >

CCR - COLOR  
COULEUR

**00**

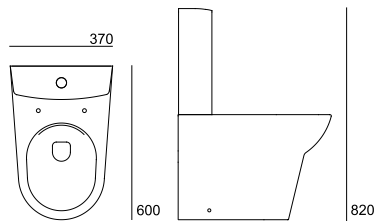

Sanita . Inodoro . Toilet . Toilette  
**42551XX2V**  
**42551XX2H**

Tanque . Cistern . Réservoir  
**42182XX2K**

Tampo . Tapa . Cover . Abattant  
**50204XX0 [SLIM SC]**  
**50205XX0 [SLIM]**  
**50210XX0 [SC]**  
**50211XX0**

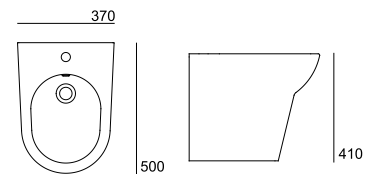

Bidé . Bidet  
**42411XX2K**

< 72



Fidji Banheira . Bañera .  
 Bathtub . Baignoire  
**5069525XC**

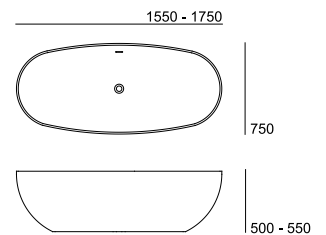

Light Banheira . Bañera . Bathtub . Baignoire  
**51200005** [170x75cm]  
**51200004** [155x75cm]

## cores

colores . colors . couleurs

sanitários . sanitarios .  
 sanitary ware . toilettes

xx= 00

torneiras . griferia .  
 taps . robinets

x= 2 3 5

**Outras cores sob consulta**  
 Otros colores bajo consulta  
 Other colours on request  
 Autres couleurs sur demande

# 100

compacta . para tanque baixo . close coupled . compacte

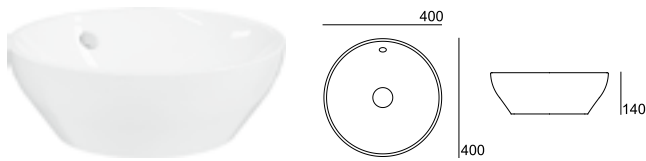

Lavatório . Lavabo . Washbasin  
**42350XX2C**

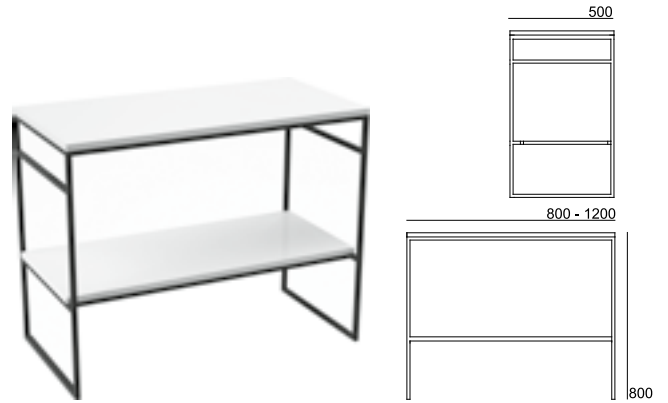

Lis Estrutura . Estructura . Frame . Structure  
**5287X123** [120x50cm]  
**5287X103** [100x50cm]  
**5287X083** [80x50cm]

Ver página 132 . See page 132 . Voir page 132

73 >



Fidji Lavatório mural . Lavabo mural .  
Wall mounted washbasin . Lavabo au mur  
**5069582XC**



Fidji Bidé . Bidet  
**5069504X**





< 74

As linhas simples e delicadas, traduzem a leveza de uma marca. Esta é a série que representa um centenário. Este é o orgulho de um legado.  
Las líneas sencillas y dedicadas traducen la levedad de una marca. Esta colección representa un centenário. Es el orgullo de un legado.  
The simple and delicate lines translate the lightness of a brand. This is the series that represents a centenary. This is the pride of a legacy.  
Les lignes simples et délicates traduisent la légèreté d'une marque. C'est la série qui représente un centenaire. C'est la fierté d'un héritage.

# 100

suspensa . suspendida . wall hung . suspendue



75 >

COR . COLOR  
COULEUR

00

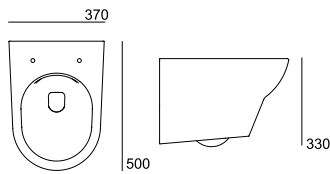

Sanita . Inodoro . Toilet . Toilette  
**42501XX2K**

Tampo . Tapa . Cover . Abattant  
**50204XX0 [SLIM SC]**  
**50205XX0 [SLIM]**  
**50210XX0 [SC]**  
**50211XX0**

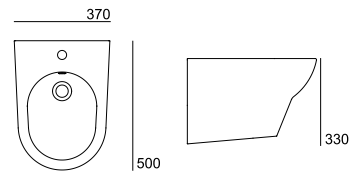

Bidé . Bidet  
**42401XX2K**

< 76



Square Placa de comando .  
Paneles de control . Command panels .  
Plaques de commande  
**5503430X**

Ver página 97 . See page 97 . Voir page 97



Cayenne Lavatório mural .  
Lavabo mural .  
Wall mounted washbasin .  
Lavabo au mur  
**5061562X**



Cayenne Bidé . Bidet  
**5061504X**

## cores

colores . colors . couleurs

sanitários . sanitarios .  
sanitary ware . toilettes

xx= 00

torneiras . griferia .  
taps . robinets

x= 2 3 0

Outras cores sob consulta  
Otros colores bajo consulta  
Other colours on request  
Autres couleurs sur demande

# 100

suspensa . suspendida . wall hung . suspendue

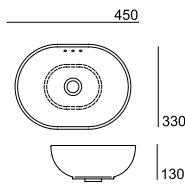

**Ticiano Lavatório . Lavabo . Washbasin**  
**78891XX2C**

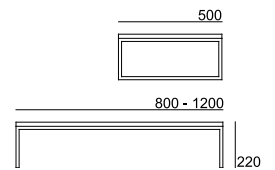

**Onor Estrutura . Estructura . Frame . Structure**  
**5287X123** [120x50cm]  
**5287X103** [100x50cm]  
**5287X083** [80x50cm]

Ver página 133 . See page 133 . Voir page 133

77 >



**Cayenne Duche . Ducha . Shower . Douche**  
**5062557X - 2 Saídas .**  
Salidas . Ways out . Sorties



**Chuveiro . Ducha . Shower . Douche**  
**5068308X**



**Flow Base chuveiro . Plato de Ducha . Shower Tray . Receveur de Douche**  
**78686102K** [140x80x3cm]  
**78684102K** [120x80x3cm]  
**78683102K** [110x80x3cm]  
**78682102K** [100x80x3cm]  
**78681102K** [90x80x3cm]  
**78680102K** [80x80x3cm]

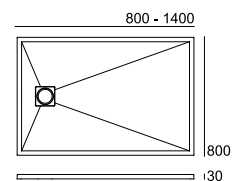



< 78

*Refletindo linhas puras e simples, a Opus personaliza volumetrias necessárias a espaços de banho mais reduzidos.*

*Al reflejar la líneas puras y sencillas, Opus personaliza volumetrias necesarias en los espacios de baño más reducidos.*

*Reflecting pure and simple lines, Opus customizes the volumes necessary for smaller bathroom spaces.*

*Reflétant des lignes pures et simples, Opus personnalise les volumes nécessaires aux petits espaces de salle de bain.*



# OPUS

compacta . para tanque bajo . close coupled . compacte



79 >

CDR . COLOR  
COULEUR

00



**Sanita . Inodoro . Toilet . Toilette**  
**37051XX2V**  
**37051XX2H**

**Tanque . Cistern . Réservoir**  
**37182XX2K [↓]**  
**37181XX2K [→]**

**Tampo . Tapa . Cover . Abattant**  
**50206XX0 [SC]**  
**50207XX0**

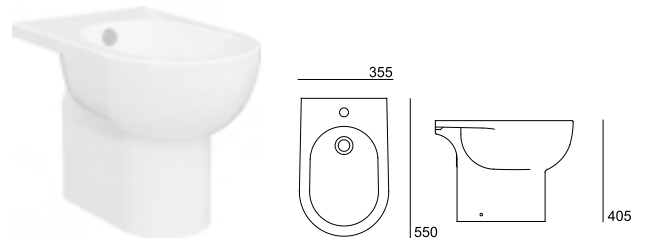

**Bidé . Bidet**  
**37411XX2K**

**Alternativa ao produto apresentado em ambiente .**  
*Alternativa al producto presentado en ambiente ·*  
*Alternative to the product presented in the environment ·*  
*Alternative au produit présenté dans l'environnement*

< 80



**Sanita BTW . Inodoro BTW . BTW Toilet . Toilette BTW**  
**37071XX2V**  
**37071XX2H**

**Tampo . Tapa . Cover . Abattant**  
**50206XX0 [SC]**  
**50207XX0**

**Alternativa ao produto apresentado em ambiente .**  
*Alternativa al producto presentado en ambiente ·*  
*Alternative to the product presented in the environment ·*  
*Alternative au produit présenté dans l'environnement*

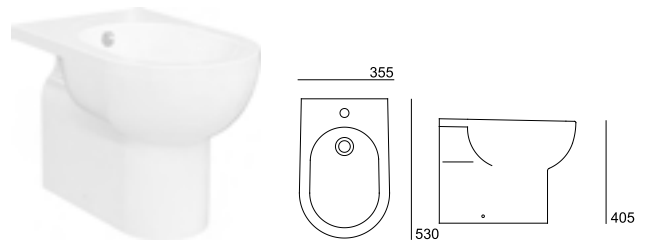

**Bidé BTW . Bidet BTW**  
**37441XX2K**

## cores

colores . colors . couleurs

**sanitários . sanitarios .**  
*sanitary ware . toilettes*

xx= 00

**torneiras . griferia .**  
*taps · robinets*

x= 2

**Outras cores sob consulta**  
*Otros colores bajo consulta*  
*Other colours on request*  
*Autres couleurs sur demande*

# OPUS

compacta . para tanque bajo . close coupled . compacte

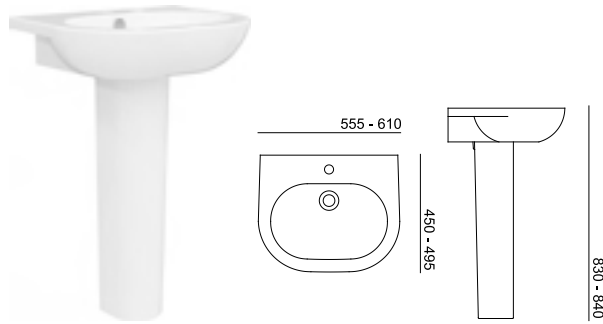

Lavatório . Lavabo . Washbasin

**37331XX2C** [61x50x19cm]

**37311XX2C** [56x45x18cm]

Coluna . Columna . Pedestal . Colonne

**37200XX2K**

81 >



**OLO Lavatório** . Lavabo . Basin  
**5061202X**



**OLO Bidé** . Bidet  
**5061204X**





*Refletindo linhas puras e simples, a Opus personaliza volumetrias necessárias a espaços de banho mais reduzidos.*

*Al reflejar la líneas puras y sencillas, Opus personaliza volumetrias necesarias en los espacios de baño más reducidos.*

*Reflecting pure and simple lines, Opus customizes the volumes necessary for smaller bathroom spaces.*

*Reflétant des lignes pures et simples, Opus personnalise les volumes nécessaires aux petits espaces de salle de bain.*

# OPUS

suspensa . suspendida . wall hung . suspendue



83 >

CDR - COLOR  
COULEUR

00

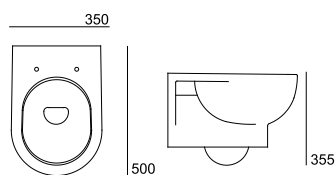

**Sanita . Inodoro . Toilet . Toilette**  
**37001XX2K**

**Tampo . Tapa . Cover . Abattant**  
**50208XX0 [SC]**  
**50209XX0**

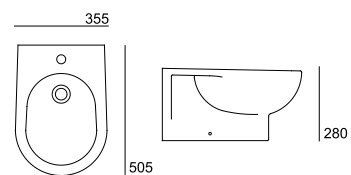

**Bidé . Bidet**  
**37401XX2K**

< 84



**Tile Placa de comando . Paneles de control .**  
**Command panels . Plaques de commande**  
**55038XXY**

Ver página 97 . See page 97 . Voir page 97

## cores

colores . colors . couleurs

sanitários . sanitarios .  
sanitary ware . toilettes

xx= 00

torneiras . griferia .  
taps . robinets

x= 2 3 0

**Outras cores sob consulta**  
Otros colores bajo consulta  
Other colours on request  
Autres couleurs sur demande

# OPUS

suspensa . suspendida . wall hung . suspendue

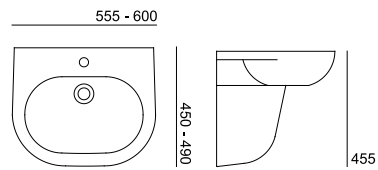

Lavatório . *Lavabo* . *Washbasin*  
**37331XX2C** [61x50x19cm]  
**37311XX2C** [56x45x18cm]

Coluna . *Columna* . *Pedestal* . *Colonne*  
**37220XX2K**

85 >



**Cayenne Lavatório .**  
*Lavabo* . *Washbasin*  
**5061502X**



**Cayenne Bidé .** *Bidet*  
**5061504X**





*Pensando nas necessidades funcionais de todos os utilizadores, a Oceanus oferece soluções para espaços mais simples.  
Al pensar en las necesidades funcionales de todos los usuarios, Oceanus ofrece soluciones para espacios más sencillos.  
Thinking about the functional needs of all users, Oceanus offers solutions for simpler spaces.  
En pensant aux besoins fonctionnels de tous les utilisateurs, Oceanus propose des solutions pour des espaces plus simples.*



# OCEANUS

compacta . para tanque bajo . close coupled . compacte



87 >

CDR . COLOR  
COULEUR

00

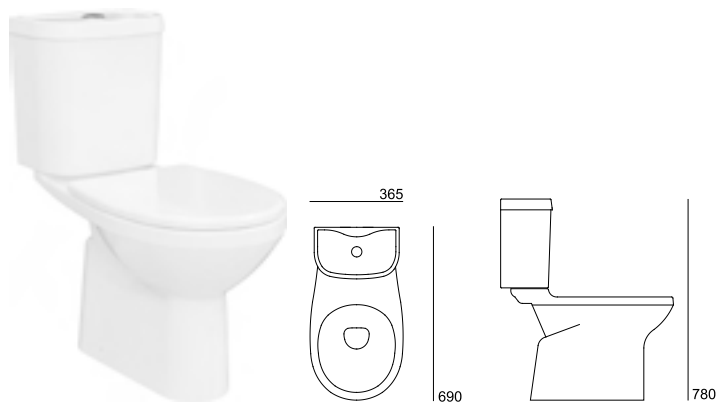

Sanita . Inodoro . Toilet . Toilette  
**13023XX2K [V]**  
**13021XX2K [H]**

Tanque . Cistern . Réservoir  
**13182XX2K [↓]**  
**13181XX2K [→]**

Tampo . Tapa . Cover . Abattant  
**50340XX0**

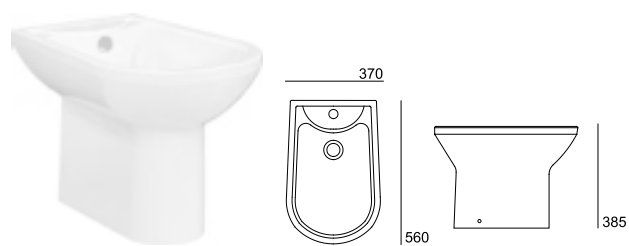

Bidé . Bidet  
**13411XX2K**

< 88



Sanita . Inodoro . Toilet . Toilette  
**13013XX2K [V]**

Tampo . Tapa . Cover . Abattant  
**50340XX0**

Alternativa ao produto apresentado em ambiente .  
 Alternativa al producto presentado en ambiente .  
 Alternative to the product presented in the environment .  
 Alternative au produit présenté dans l'environnement

## cores

colores . colors . couleurs

sanitários . sanitarios .  
 sanitary ware . toilettes

xx= 00

torneiras . griferia .  
 taps . robinets

x= 2

**Outras cores sob consulta**  
 Otros colores bajo consulta  
 Other colours on request  
 Autres couleurs sur demande

# OCEANUS

compacta . para tanque bajo . close coupled . compacte



Lavatório . Lavabo . Washbasin

**13321XX2C** [68x49x21 cm]

**13331XX2C** [61x47x21 cm]

**13311XX2C** [55x43x21 cm]

Coluna . Columna . Pedestal . Colonne

**37200XX2K**

89 >



**OLO Lavatório . Lavabo . Basin**  
**5061202X**



**OLO Bidé . Bidet**  
**5061204X**





< 90

*Pensando nas necessidades funcionais de todos os utilizadores, a Oceanus oferece soluções para espaços mais simples.  
Al pensar en las necesidades funcionales de todos los usuarios, Oceanus ofrece soluciones para espacios más sencillos.  
Thinking about the functional needs of all users, Oceanus offers solutions for simpler spaces.  
En pensant aux besoins fonctionnels de tous les utilisateurs, Oceanus propose des solutions pour des espaces plus simples.*

# OCEANUS

suspensa . suspendida . wall hung . suspendue



91 >

COB . COLOR  
COULEUR

00

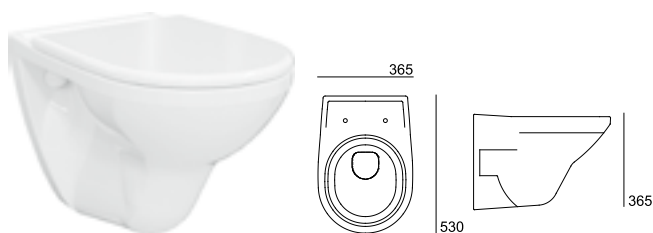

**Sanita . Inodoro . Toilet . Toilette**  
**13002XX2K**  
**Tampo . Tapa . Cover . Abattant**  
**50340XX0**

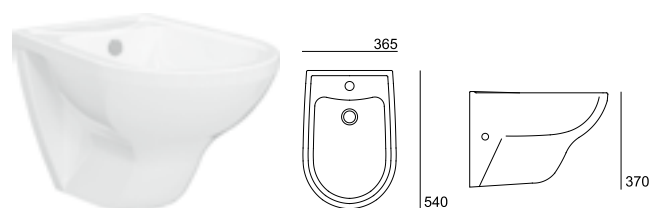

**Bidé . Bidet**  
**13401XX2K**

< 92



**Tile Placa de comando . Paneles de control .**  
**Command panels . Plaques de commande**  
**55038XXY**

Ver página 97 . See page 97 . Voir page 97

## cores

colores . colors . couleurs

sanitários . sanitarios .  
 sanitary ware . toilettes

xx= 00

torneiras . griferia .  
 taps . robinets

x= 2 3 0

**Outras cores sob consulta**  
 Otros colores bajo consulta  
 Other colours on request  
 Autres couleurs sur demande

# OCEANUS

suspensa . suspendida . wall hung . suspendue

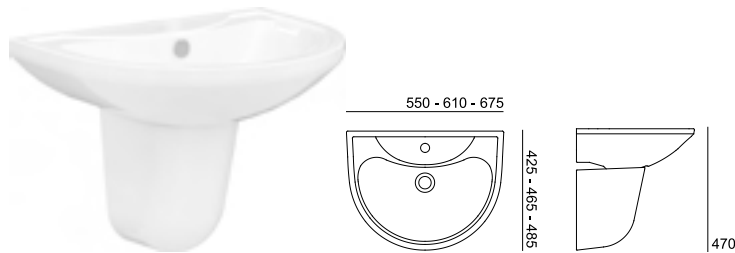

Lavatório . Lavabo . Washbasin

**13321XX2C** [68x49x21 cm]

**13331XX2C** [61x47x21 cm]

**13311XX2C** [55x43x21 cm]

Coluna . Columna . Pedestal . Colonne

**37220XX2K**

93 >



**Cayenne Lavatório .**  
*Lavabo . Washbasin*  
**5061502X**



**Cayenne Bidé . Bidet**  
**5061504X**



*Valadares*









# PLACAS DE COMANDO

paneles de control . command panels . plaques de commande



**Tile Placa de comando .**  
*Paneles de control . Command panels .*  
*Plaques de commande*  
**55038XXY**

XX= 

|    |    |    |    |
|----|----|----|----|
| 00 | 23 | 47 | 48 |
|----|----|----|----|

  
 Y= 

|   |   |   |
|---|---|---|
| 2 | 1 | 3 |
|---|---|---|



**Globe Placa de comando .**  
*Paneles de control . Command panels .*  
*Plaques de commande*  
**5503470X**

X= 

|   |   |   |
|---|---|---|
| 1 | 3 | 4 |
|---|---|---|

97 >



**Square Placa de comando .**  
*Paneles de control . Command panels .*  
*Plaques de commande*  
**5503430X**

X= 

|   |   |   |   |
|---|---|---|---|
| 1 | 3 | 4 | 5 |
|---|---|---|---|



**Plat2 Placa de comando .**  
*Paneles de control . Command panels .*  
*Plaques de commande*  
**5503420X**

X= 

|   |   |   |
|---|---|---|
| 1 | 3 | 4 |
|---|---|---|

Y= 

|   |   |   |
|---|---|---|
| 2 | 1 | 3 |
|---|---|---|

  
 Cromado . Chrome  
 Branco . Blanco . White . Blanc  
 Preto . Negro . Black . Noir

X= 

|   |   |   |   |
|---|---|---|---|
| 1 | 3 | 4 | 5 |
|---|---|---|---|

  
 Cromado . Chrome  
 Branco . Blanco . White . Blanc  
 Cromado mate . Chrome matt  
 Preto . Negro . Black . Noir

**Outras cores sob consulta**  
*Otros colores bajo consulta*  
*Other colours on request*  
*Autres couleurs sur demande*

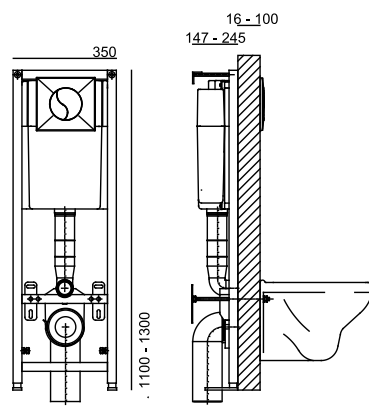

< 98

**Estrutura integral . Estructura integral .**  
*Concealed full frame . Bâti-chasse intégral*  
**55037074**

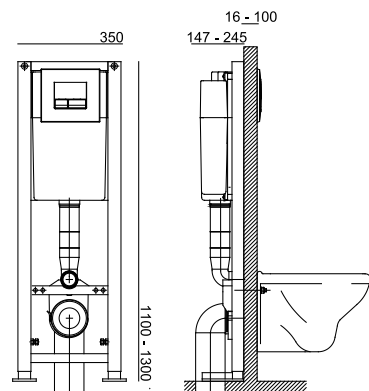

**Estrutura autoportante . Estructura autoportante .**  
*Self-supporting frame . Bâti-chasse autoportant*  
**55037076**

# ESTRUTURAS P/ SANITÁRIO SUSPENSO

estructuras p/ sanitarios suspendidos . concealed system for wall-hung wc . bâti-chasse pièces suspendue

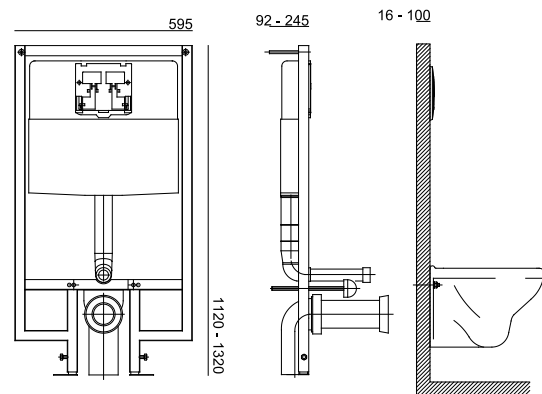

**Estrutura integral Slim . Estructura integral Slim .  
Slim concealed full frame . Bâti-chasse intégral Slim  
55037075**

99 >

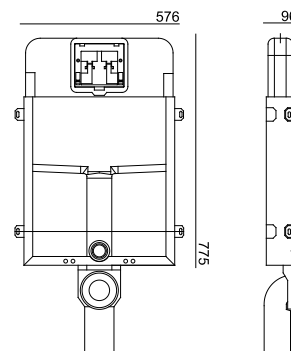

**Estrutura Intraslim . Estructura Intraslim .  
Concealed half frame Intraslim . Bâti-chasse Intraslim  
55037094**

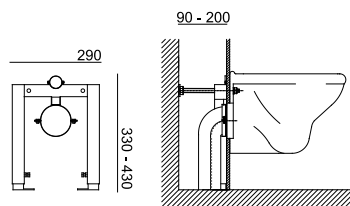

**Estrutura de sanita sem tanque . Estructura inodoro sin tanque .**  
*Wall-mounted frame toilet without flushing cistern . Bâti-chasse sans réservoir*  
**55036201**

< 100

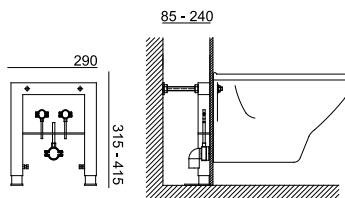

**Estrutura p/bidés suspensos . Estructura para bidés suspendidos .**  
*Frame for wall-hung bidets . Bâti-chasse pour bidets suspendues*  
**55046001** Fixação invisível . fijación invisible . invisible fixation . fixation invisible  
**55046001K** Fixação visível . fijación visible . visible fixation . fixation visible

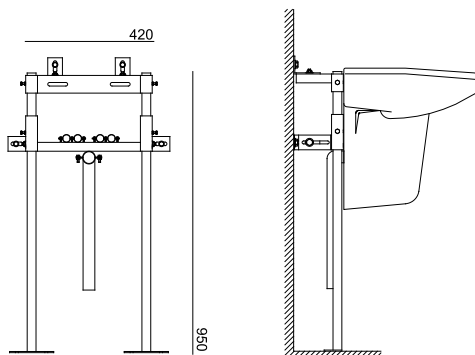

**Estrutura p/ lavatório suspenso . Estructura para lavabo suspendido .**  
*Washbasin wall-mount frame . Bâti-chasse pour lavabos suspendues*  
**55035001**

# ESTRUTURAS P/ SANITÁRIO SUSPENSO

estructuras p/ sanitarios suspendidos . concealed system for wall-hung wc . bâti-chasse pièces suspendue

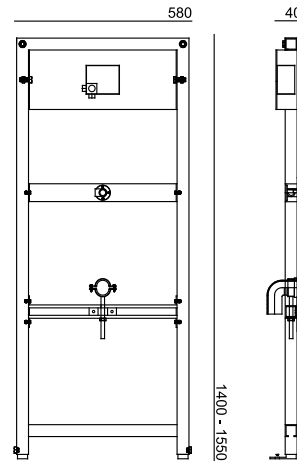

**Egg / Kino Estrutura urinol . Estructura de urinarios .  
Urinals frame . Support pour installation d'urinoirs  
55036010**

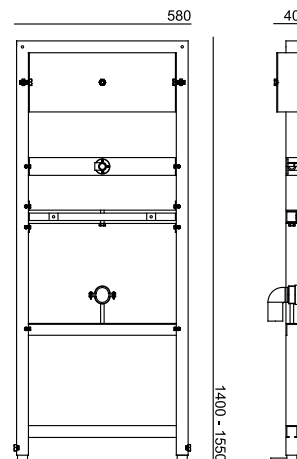

**Orbital / Florida Estrutura urinol . Estructura de urinarios .  
Urinals frame . Support pour installation d'urinoirs  
55036011**

**Face Estrutura urinol . Estructura de urinarios .  
Urinals frame . Support pour installation d'urinoirs  
55036012**

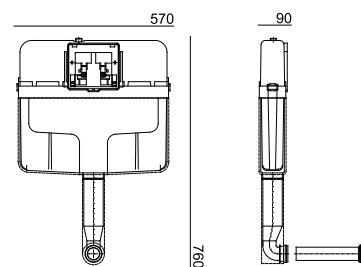

**Tanque encastrável dupla descarga . Tanque empotrado double descarga .  
Dual flush concealed cistern . Reservoir encastré double volume  
55037091**

*Valadares*

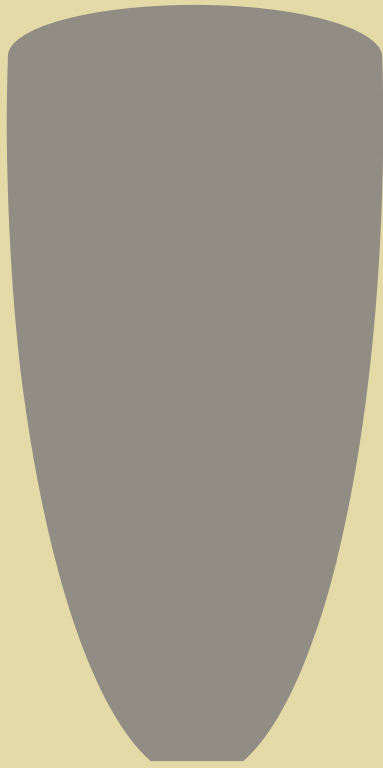



# LAVATÓRIOS

LAVABOS . WASHBASINS

## ESPECIAIS

ESPECIALES . SPECIALS . SPÉCIAUX

*p. 104 - 109*

## SUSPENSOS

SUSPENDIDOS . WALL-HUNG . SUSPENDUES

*p. 110 - 111*

## LAVA MÃOS

LAVA MANOS . HAND WASHBASINS . LAVE-MAINS

*p. 112 - 113*

## POUSAR

SOBRE MUEBLE . STANDING . À POSER

*p. 114 - 121*

## EMBUTIR

SOBRE ENCIMERA . EMBEDDED . À ENCASTRER SUR MEUBLE

*p. 122 - 123*

## SEMI-EMBUTIR

SEMI-INTEGRAR . SEMI-EMBEDDED . SEMI-ENCASTRER

*p. 124 - 125*

## ENCASTRAR

BAJO ENCIMERA . RECESSED . À ENCASTRER EN DESSOUS

*p. 126 - 127*



< 104

lavatório . lavabo . washbasin  
**KOBE**

COR . COLOR  
COULEUR

13

# ESPECIAIS

especiales . special . spéciaux

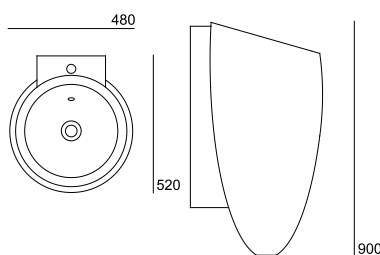

**Egg**  
**39881XX2C**

105 >

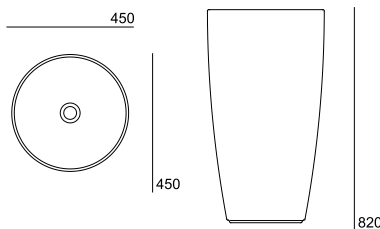

**Kobe Lavatório . Lavabo . Washbasin**  
**79910XX2C** - com saída inferior . con salida inferior .  
with bottom outlet . avec sortie inférieure  
**79911XX2C** - com saída lateral . con salida lateral .  
with side outlet . avec sortie latérale

## cores

colores . colors . couleurs

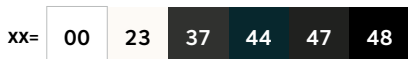

**Outras cores sob consulta**  
Otros colores bajo consulta  
Other colours on request  
Autres couleurs sur demande

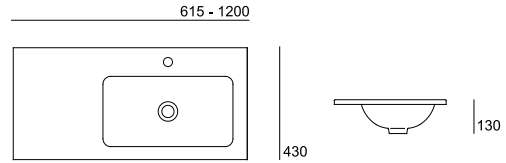

**Platinum**

- 79363XX2C** [120x43x13cm]
- 79353XX2C** [110x43x13cm]
- 79343XX2C** [100x43x13cm]
- 79333XX2C** [90x43x13cm]
- 79323XX2C** [80x43x13cm]

Ver estructura página 135 . Ver estructura en la página 135 .  
See structure page 135 . Voir la structure à la page 135

< 106

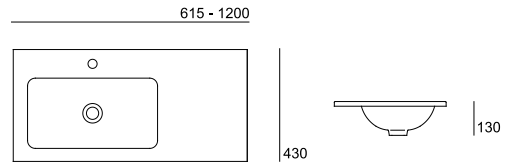

**Platinum**

- 79362XX2C** [120x43x13cm]
- 79352XX2C** [110x43x13cm]
- 79342XX2C** [100x43x13cm]
- 79332XX2C** [90x43x13cm]
- 79322XX2C** [80x43x13cm]

Ver estructura página 135 . Ver estructura en la página 135 .  
See structure page 135 . Voir la structure à la page 135

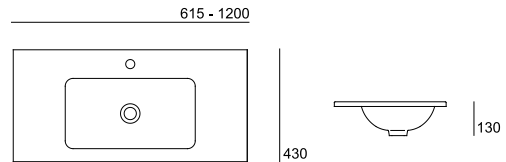

**Platinum**

- 79361XX2C** [120x43x13cm]
- 79351XX2C** [110x43x13cm]
- 79341XX2C** [100x43x13cm]
- 79331XX2C** [90x43x13cm]
- 79321XX2C** [80x43x13cm]
- 79301XX2C** [60x43x13cm]

Ver estructura página 135 . Ver estructura en la página 135 .  
See structure page 135 . Voir la structure à la page 135

**cores**

cores . colors . couleurs

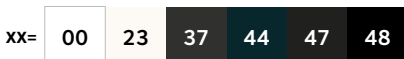

**Outras cores sob consulta**  
Otros colores bajo consulta  
Other colours on request  
Autres couleurs sur demande

# ESPECIAIS

especiales . special . spéciaux

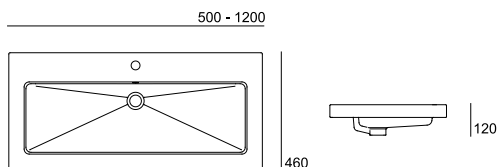

## Rafael

**79831XX2C** [120x46x12cm]

**79821XX2C** [100x46x12cm]

**79811XX2C** [80x46x12cm]

**79801XX2C** [60x46x12cm]

**79861XX2C** [50x46x12cm]

Ver estructura página 135 . Ver estructura en la página 135 .  
See structure page 135 . Voir la structure à la page 135

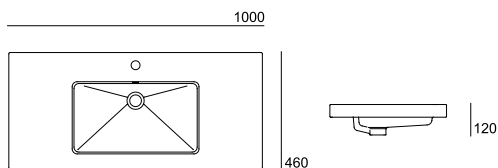

## Rafael

**79851XX2C** [100x46x12cm]

Ver estructura página 135 . Ver estructura en la página 135 .  
See structure page 135 . Voir la structure à la page 135

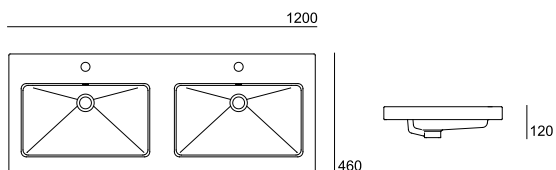

## Rafael

**79842XX2C** [120x46x12cm]

Ver estructura página 135 . Ver estructura en la página 135 .  
See structure page 135 . Voir la structure à la page 135

107 >



Rubens  
79900XX2C

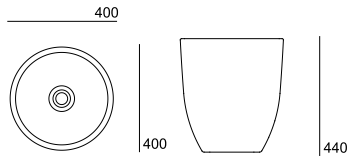

Porto  
79621XX2C

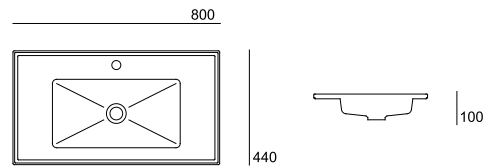

< 108



lavatório . lavabo . washbasin  
**RUBENS**

CDR . COLOR  
COULEUR

# ESPECIAIS

especiales . special . spéciaux



**Apolo**

**78331XX2C** [120x55x25cm]

**78321XX2C** [100x55x25cm]

**78311XX2C** [80x55x25cm]

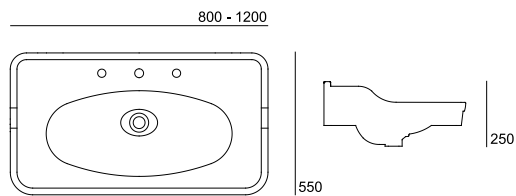

Ver estrutura página 134 . Ver estructura en la página 134  
See structure page 134 . Voir la structure à la page 134



**Neo**

**16381XX2C**

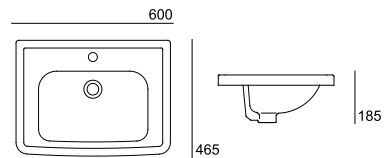

Ver estrutura página 135 . Ver estructura en la página 135  
See structure page 135 . Voir la structure à la page 135

109 >



**Serras**

**78840XX2C**

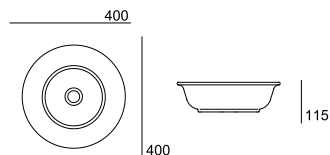

Ver estrutura página 134 . Ver estructura en la página 134  
See structure page 134 . Voir la structure à la page 134



**Neo**

**16387XX2C**

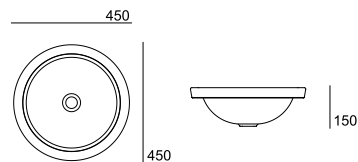

Ver estrutura página 134 . Ver estructura en la página 134  
See structure page 134 . Voir la structure à la page 134

## cores

colores . colors . couleurs

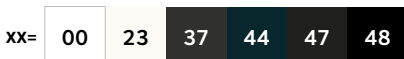

**Outras cores sob consulta**

Otros colores bajo consulta  
Other colours on request  
Autres couleurs sur demande

original bathrooms since 1921

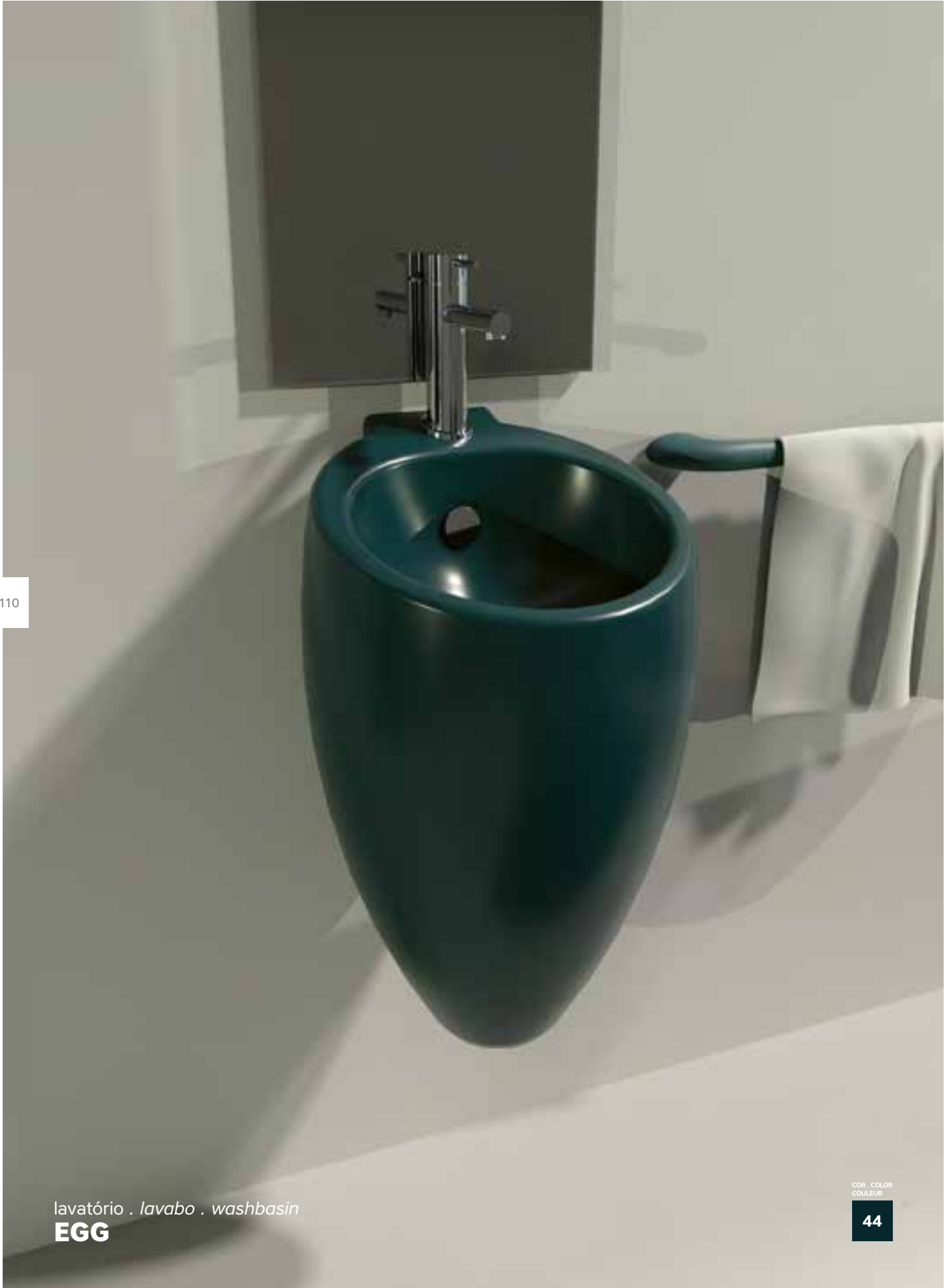

< 110

lavatório . lavabo . washbasin  
**EGG**

COR . COLOR  
COULEUR

**44**



# SUSPENSOS

suspendidos . wall-hung . suspendus



**Recife Plus**  
**78761XX2C**

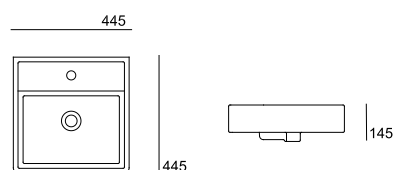

**Egg**  
**39871XX2K**

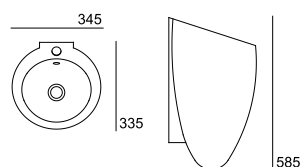

**One Line**

- 40331XX2C** [120x45x12cm]
- 40321XX2C** [100x45x12cm]
- 40361XX2C** [90x45x12cm]
- 40311XX2C** [80x45x12cm]
- 40341XX2C** [70x45x12cm]
- 40301XX2C** [60x45x12cm]

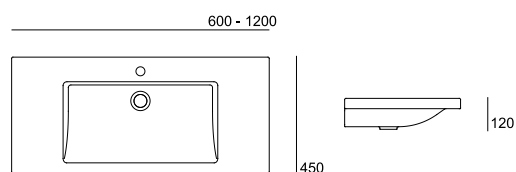

Ver estructura página 135 . Ver estructura en la página 135  
See structure page 135 . Voir la structure à la page 135



**Aviz**

- 79741XX2C** [100x40x10cm]
- 79721XX2C** [80x40x10cm]
- 79701XX2C** [60x40x10cm]

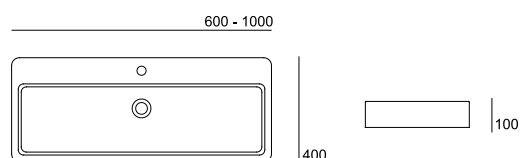

**Gallery**

- 78821XX2C** [76x50x12cm]
- 78831XX2C** [76x50x12cm]

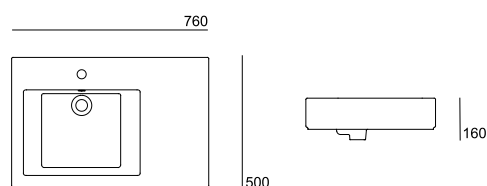

Ver estructura página 134 . Ver estructura en la página 134  
See structure page 134 . Voir la structure à la page 134

## cores

colores . colors . couleurs

xx= 00

**Outras cores sob consulta**  
Otros colores bajo consulta  
Other colours on request  
Autres couleurs sur demande



Neo  
16361XX2C

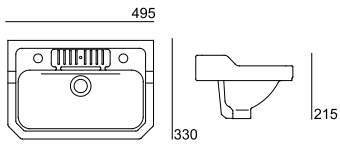

Canto  
18307XX2C

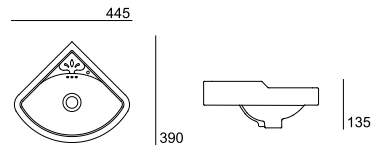

# LAVA MÃOS

lava manos . hand washbasins . lave-mains



**Ísis**

**78813XX2C** [53x28x12cm]

**78812XX2C** [53x28x12cm]



**Ceuta**

**18801XX2C**

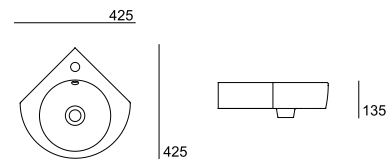

Ver estrutura página 135 . Ver estructura en la página 135  
See structure page 135 . Voir la structure à la page 135



**Eros**

**18851XX2C**

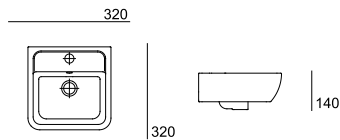

**Lava-Mãos**

**12361XX2C**

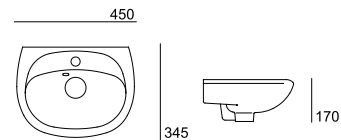

**Vénus**

**18863XX2C** [44x36x10cm]

**18862XX2C** [44x36x10cm]

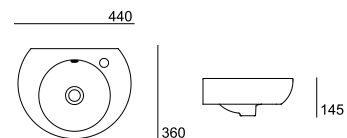

## cores

colores . colors . couleurs

**Outras cores sob consulta**

Otros colores bajo consulta  
Other colours on request  
Autres couleurs sur demande

xx= 00



**Chagall**  
**78865XX2C** [60x35x14cm]  
**78860XX2C** [60x35x10cm]  
**78850XX2C** [40x35x10cm]



**Ticiano**  
**78891XX2C**

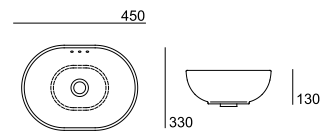

< 114



lavatório . lavabo . washbasin  
**CHAGALL**

COR . COLOR  
COULEUR

# POUSAR

sobre mueble . standing . à poser



**Renoir**  
**78897XX2C**

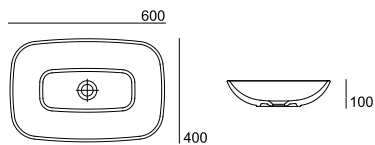

**100**  
**42350XX2C**

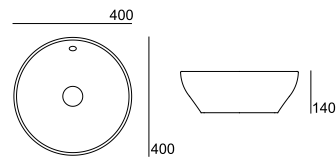

115 >



**Aviz V4**  
**79744XX2C** [100x40x10cm]  
**79724XX2C** [80x40x10cm]  
**79704XX2C** [60x40x10cm]

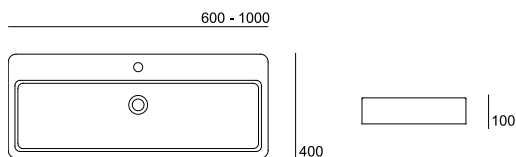

**Bari**  
**79441XX2C** [80x40x11cm]  
**79431XX2C** [60x40x11cm]  
**79421XX2C** [50x40x11cm]  
**79411XX2C** [40x40x11cm]

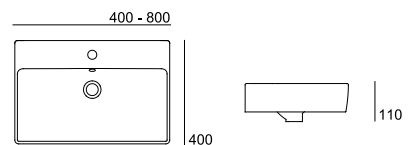

## cores

colores . colors . couleurs



**Outras cores sob consulta**  
*Otros colores bajo consulta*  
*Other colours on request*  
*Autres couleurs sur demande*



Savoy  
18890XX2C

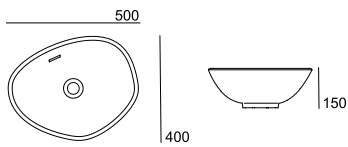

Van Gogh  
78867XX2C

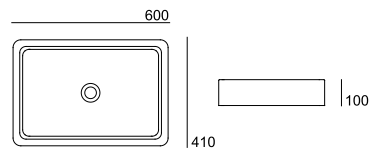

< 116



lavatório . lavabo . washbasin  
**SAVOY**

CDR . COLOR  
COULEUR

27

# POUSAR

sobre mueble . standing . à poser



**Ísis**  
**78811XX2C**

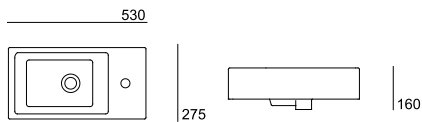

**Recife Plus V4**  
**78764XX2C**

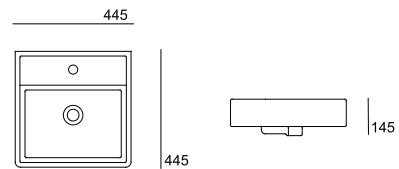

117 >



**Egg**  
**39357XX2C**

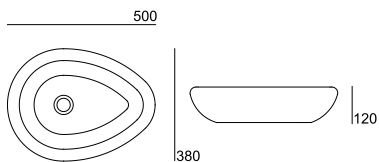

**Macau**  
**78857XX2C**

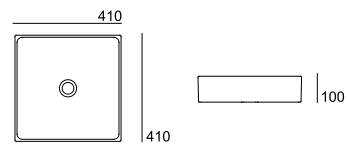

## cores

colores . colors . couleurs



**Outras cores sob consulta**  
Otros colores bajo consulta  
Other colours on request  
Autres couleurs sur demande



**Malibu**  
**78737XX2C**

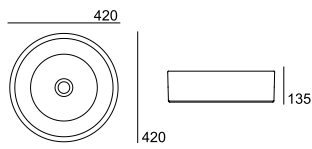

**One Slim**  
**40357XX2C**

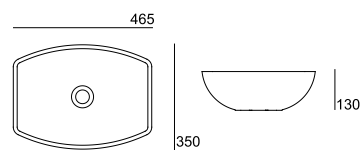

< 118



lavatório . lavabo . washbasin  
**MALIBU**

COR . COLOR  
COULEUR

41



# POUSAR

sobre mueble . standing . à poser



**Picasso**  
**78357XX2K**

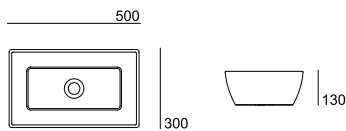

**Taiti**  
**78731XX2C**

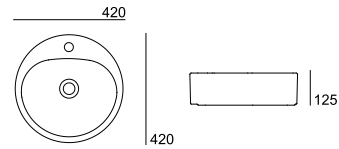

**Zen**  
**79920XX2C**

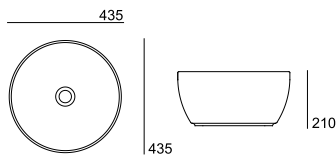

**Boston**  
**18717XX2C**

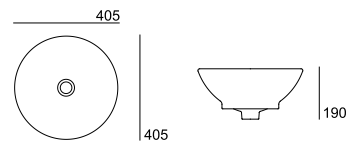

119 >

## cores

colores . colors . couleurs



**Outras cores sob consulta**  
*Otros colores bajo consulta*  
*Other colours on request*  
*Autres couleurs sur demande*



lavatório . lavabo . washbasin  
**DARK**

COR . COLOR  
COULEUR

21

< 120



lavatório . lavabo . washbasin  
**DAYTONA**

COR . COLOR  
COULEUR

38

# POUSAR

sobre mueble . standing . à poser



**Dark**  
**18797XX2C**

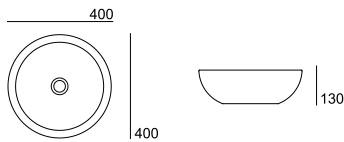

**Urano**  
**18871XX2C**

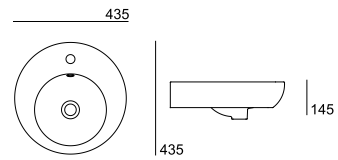

121 >



**Daytona**  
**18817XX2C**

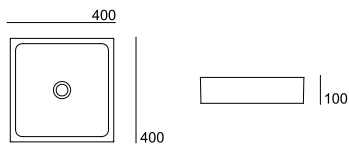

**Miami**  
**18701XX2C**

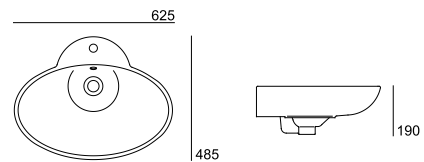

## cores

colores . colors . couleurs

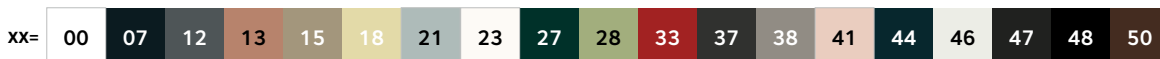

**Outras cores sob consulta**  
Otros colores bajo consulta  
Other colours on request  
Autres couleurs sur demande



< 122

lavatório . *lavabo* . washbasin  
**PALM**

CDR . COLOR

50

# EMBUTIR

sobre encimera . embedded . à encastrer sur meuble



**Goa**  
**78707XX2C**

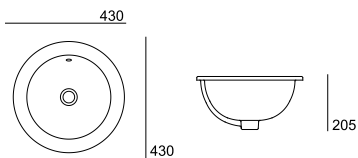

**Miramar**  
**18361XX2C**

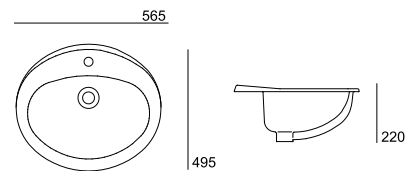

123 >



**Oásis**  
**18841XX2C**

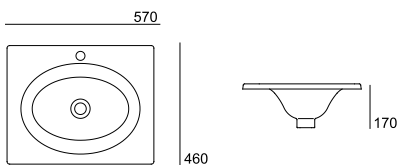

**Palm**  
**18807XX2C**

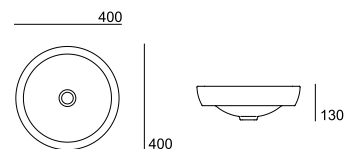

## cores

colores . colors . couleurs

xx= 00

**Outras cores sob consulta**  
*Otros colores bajo consulta*  
*Other colours on request*  
*Autres couleurs sur demande*

original bathrooms since 1921



< 124

lavatório . lavabo . washbasin  
**BARI**

COR . COLOR  
COULEUR

48

# SEMI-EMBUTIR

semi-integrar . semi-embedded . semi-encastrer



**Bari**  
**18881XX2C**

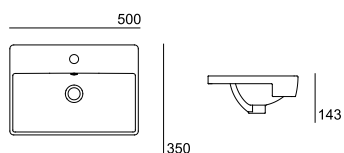

**Roma**  
**18751XX2C**

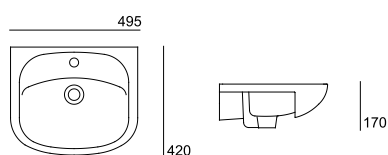

**Torino**  
**18341XX2C**

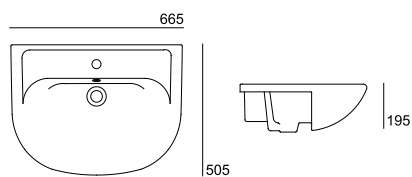

125 >

## cores

colores . colors . couleurs

xx= 00

**Outras cores sob consulta**  
*Otros colores bajo consulta*  
*Other colours on request*  
*Autres couleurs sur demande*



**Toledo**  
**78868XX2C** [65x38x8cm]  
**78848XX2C** [45x38x8cm]

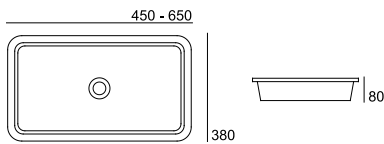

**Tânger**  
**18777XX2C** [55x35x16cm]  
**18775XX2C** [50x34x16cm]

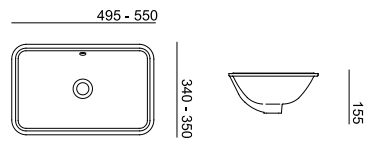

< 126



lavatório . lavabo . washbasin  
**TOLEDO**

COR . COLOR  
COULEUR  
**00**



# ENCASTRAR

bajo encimera . recessed . à encastrer en dessous



**Dali**  
**18887XX2C**

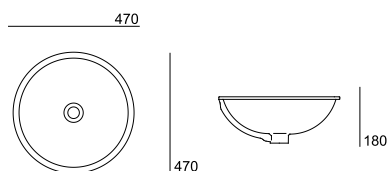

**Oval**  
**18327XX2C**

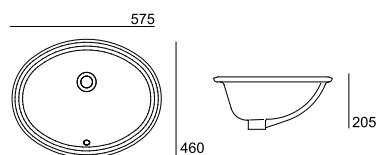

127 >



**Nice**  
**18381XX2C**

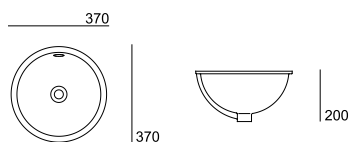

**Missouri**  
**18767XX2C**

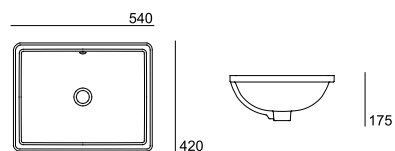

## cores

colores . colors . couleurs

xx= 00

**Outras cores sob consulta**  
*Otros colores bajo consulta*  
*Other colours on request*  
*Autres couleurs sur demande*

# Valadares

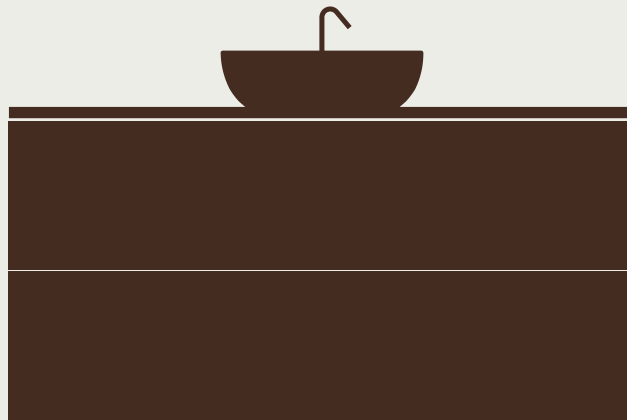

# PLACA CERÂMICA

ENCIMERA EN CERÁMICA . CERAMIC TOP . ASSIETTE EN CÉRAMIQUE

*p. 130 - 131*

# ESTRUTURAS DE BANCADA

ESTRUTURAS DE ENCIMERA . TOP FRAMES . STRUCTURES POUR ASSIETTES

*p. 132 - 135*

# MÓVEIS

MUEBLES . FURNITURE . MEUBLES

*p. 136 - 137*



< 130

CDR - COLOR  
COULEUR

00

# PLACA CERÂMICA

encimera en cerámica . ceramic top . assiette en céramique



Placa cerâmica . encimeras en cerámica .  
ceramic tops . assiettes en céramique

**70240XX2C** [100x50x2cm]

**70140XX2C** [80x50x2cm]

**70040XX2C** [60x50x2cm]

131 >

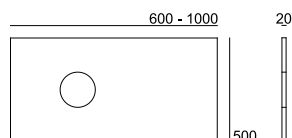

**Furações sob consulta**

*Perforaciones bajo consulta*

*Drillings on request*

*Forages sur demande*



**Suportes fixação . Soportes de fijación .**

*Fixing supports . Supports de fixation*

**5518115X**

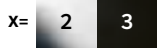

## cores

*colores . colors . couleurs*

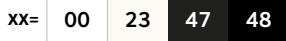

**Outras cores sob consulta**

*Otros colores bajo consulta*

*Other colours on request*

*Autres couleurs sur demande*

original bathrooms since 1921



**Lis**  
**5289X123** [120x50cm]  
**5289X103** [100x50cm]  
**5289X083** [80x50cm]

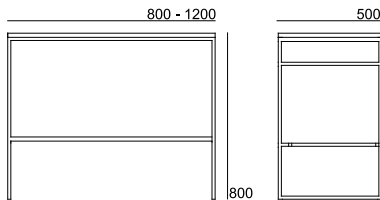

**Lena**  
**5288X123** [120x50cm]  
**5288X103** [100x50cm]  
**5288X083** [80x50cm]

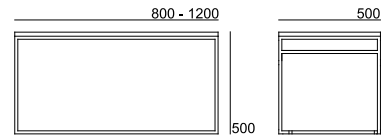

**LENA**

# ESTRUTURAS

estructuras . frames . structures



Onor

**5287X123** [120x50cm]

**5287X103** [100x50cm]

**5287X083** [80x50cm]

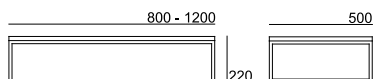

133 >

Outras acabamentos sob consulta

*Otros acabados bajo consulta*

*Other finishings on request*

*Autres finitions sur demande*

**X= Opções de pedra para os tampos . Opciones de piedra para encimeras . Stone options for tops . Options de pierre pour les dessus**

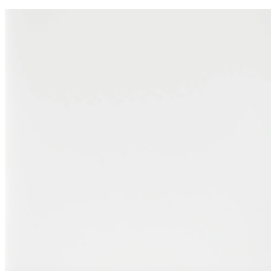

0 - Crystal White

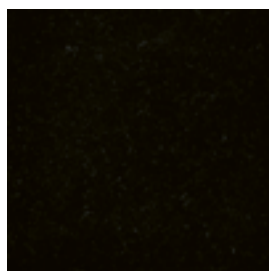

1 - Absolute Black Granite



2 - Carrara White

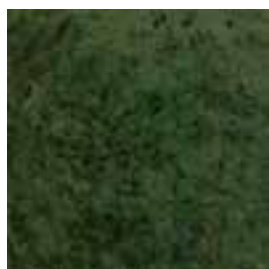

3 - Indian Green



4 - Marron Imperador Dark



5 - Teak Wood Grey



6 - Travertino Italy



**Apoio**  
**507000YX**

Para mais informação consultar tabela de preços .  
Para más información ver lista de precios .  
For more information see price list .  
Pour plus d'informations, voir la liste de prix

x= 2 5



**Estrutura para lavatório serras e neo de embutir redondo .**  
*Estructura para lavabo serras y neo sobre encimera .*  
*Structure for serras and neo embedded rounded washbasins .*  
*Structure pour lavabo serras et neo arrondi à encastrer*  
**5518201XZZ**

x= 1 3 zz= 00 23 37 44 47 48

< 134



**Rafael Estrutura . Estructura . Frame . Structure**  
**551813YX**

**Rafael Prateleira . Estante . Shelf . Étagère**  
**551814YX**

Para mais informação consultar tabela de preços .  
Para más información ver tarifa de precios .  
For more information see price list .  
Pour plus d'informations, voir la liste de prix

x= 2 3



**Estrutura suspensa para lavatório serras e neo de embutir redondo .**  
*Estructura suspendida para lavabo serras y neo sobre encimera .*  
*Wall hung structure for serras and neo embedded rounded washbasins .*  
*Structure suspendue pour lavabo serras et neo arrondi à encastrer*  
**5518203XZZ**

x= 1 3 zz= 00 23 37 44 47 48



**One Line Toalheiro . Toallero .**  
*Towel rail . Porte-serviettes*  
**55174YYX**

Para mais informação consultar tabela de preços .  
Para más información ver tarifa de precios .  
For more information see price list .  
Pour plus d'informations, voir la liste de prix

x= 0 3



**Gallery Toalheiro . Toallero .**  
*Towel rail . Porte-serviette*  
**551740YX**

Para mais informação consultar tabela de preços .  
Para más información ver tarifa de precios .  
For more information see price list .  
Pour plus d'informations, voir la liste de prix

x= 2



# ESTRUTURAS

estructuras . frames . structures



**Rafael/Platinum/One Line Estrutura .**

*Estructura . Frame . Structure*

**55189YYX**

Para mais informação consultar tabela de preços .

*Para más información ver tarifa de precios .*

*For more information see price list .*

*Pour plus d'informations, voir la liste de prix*

x= 2 3



**Estrutura para lavatorio Neo de embutir retangular .**

*Estructura para lavabo rectangular Neo sobre encimera .*

*Structure for Neo embedded rectangular washbasin .*

*Structure pour lavabo rectangulaire à encastrer Neo*

**5518200X**

x= 2



**Platinum Toalheiro . Toallero .**

*Towel rail . Porte-serviette*

**55174YYX**

**Suportes fixação . Soportes de fijación .**

*Fixing supports . Supports de fixation*

**5518110X**

Para mais informação consultar tabela de preços .

*Para más información ver tarifa de precios .*

*For more information see price list .*

*Pour plus d'informations, voir la liste de prix*

x= 2 3



**Suportes de fixação . Soportes fijación .**

*Fixing supports . Supports de fixation*

**5518100X** [Platinum - 40cm]

**5518113X** [Rafael - 43cm]

**5518115X** [Placa cerâmica . Encimera en cerámica .

*Ceramic top . Assiette en céramique - 47cm]*

Para mais informação consultar tabela de preços .

*Para más información ver tarifa de precios .*

*For more information see price list .*

*Pour plus d'informations, voir la liste de prix*

x= 2 3



**Ceuta Toalheiro . Toallero .**

*Towel rail . Porte-serviettes*

**5517400X**

x= 2

**YY | Y**

**Consultar diferentes dimensões de estruturas**

*Consultar diferentes dimensiones de estructuras*

*Consult different dimensions of structures*

*Consulter les différentes dimensions des structures*



# MÓVEIS

muebles . furniture . meubles



## Aviz

**C/ gavetão e gaveta interior** . Con cajón y cajón interior .  
With drawer and inner drawer . Avec tiroir et tiroir intérieur

**C/ gavetão** . Con cajón .  
With drawer . Avec tiroir

**C/ 2 portas** . Con 2 puertas .  
With 2 doors . Avec 2 portes

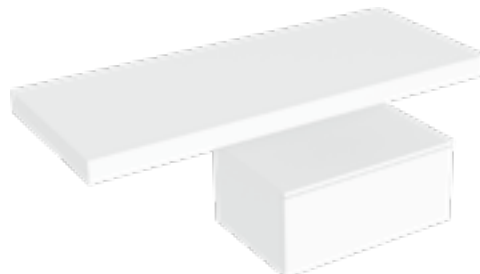
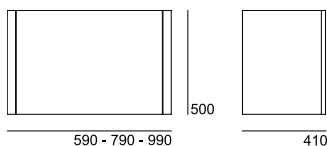

## Table

**Bancada** . Encimera . Top . Table

**Módulo de gaveta** . módulo de cajón .  
Drawer module . Module de tiroir

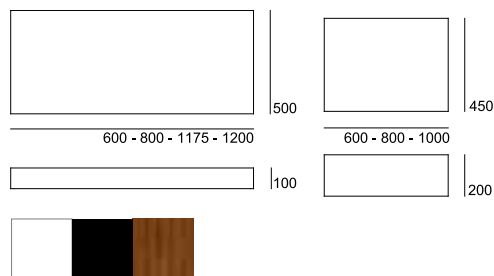

## Box 50

**C/ tampo** . Con encimera . With top . Avec table

**S/ tampo** . Sin encimera . Without top . Sans table

**C/ gavetão e gaveta interior** . Con cajón y cajón interior .  
With drawer and inner drawer . Avec tiroir et tiroir intérieur

**C/ gavetão** . Con cajón . With drawer . Avec tiroir

**C/ 2 gavetas** . Con 2 cajones . With 2 drawers . Avec 2 tiroirs

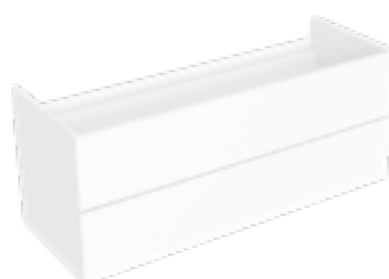
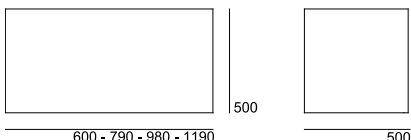

## Box 43

**C/ gavetão e gaveta interior** . Con cajón y cajón interior .  
With drawer and inner drawer . Avec tiroir et tiroir intérieur

**C/ gavetão** . Con cajón . With drawer . Avec tiroir

**C/ 2 gavetas** . Con 2 cajones . With 2 drawers . Avec 2 tiroirs

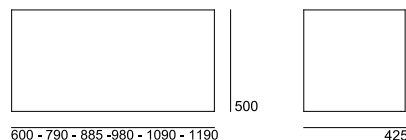

## acabamentos

acabados . finishings . finitions



**00**  
Branco . Blanco  
White . Blanche



**48**  
Preto brilho . Negro Brillo  
Black shine . Noir brillant



**76**  
Nogueira . Nogueira  
Walnut . Noyer

Para mais informação consultar tabela de preços .  
Para más información ver tarifa de precios .  
For more information see price list .  
Pour plus d'informations, voir la liste de prix

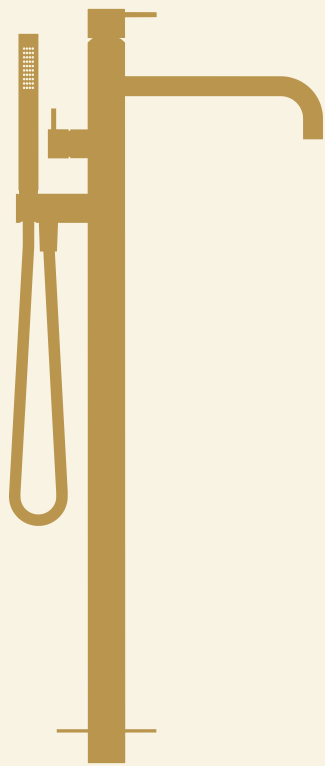

# TORNEIRAS

GRIFERIA . TAPS . ROBINETS

## LUNA

*p. 140 - 143*

## LOTTO

*p. 144 - 147*

## FIDJI

*p. 148 - 151*

## LINE

*p. 152 - 155*

## CLASSIC

*p. 156 - 159*

## CAYENNE

*p. 160 - 165*

## OLO

*p. 166 - 169*

## TERMOESTÁTICAS

TERMOSTATICOS . THERMOSTATIC . THERMOSTATIQUES

*p. 170*

## COLUNAS DE DUCHE

COLUMNAS DE DUCHA . SHOWER COLUMNS . DOUCHES AVEC COLONNE

*p. 171*

## SENSOR

*p. 172 - 173*

## TEMPORIZADAS

TEMPORIZADOS . TIMER TAPS . TEMPORISÉS

*p. 174 - 175*



Lavatório . Lavabo . Washbasin  
5062132YXX



Válvula . Valve . Vanne  
5511002YXX

< 140



# LUNA



Lavatório . Lavabo . Washbasin  
5062122YXX



Lavatório . Lavabo . Washbasin  
5062102YXX

141 >



Bidé . Bidet  
5062104YXX



Cozinha . Cocina . Kitchen . Cuisine  
5062148YXX

## cores

colores . colors . couleurs



Outras cores sob consulta  
Otros colores bajo consulta  
Other colours on request  
Autres couleurs sur demande

original bathrooms since 1921



**Duche . Ducha . Shower . Douche**  
**5062106YXX**



**Banheira . Bañera . Bathtub . Baignoire**  
**5062105YXX**

< 142





# LUNA



Duche . Ducha . Shower . Douche  
**5062107YXX** - 1 Saída .  
Salida . Way out . Sortie



Duche . Ducha . Shower . Douche  
**5062127YXX** - 2 Saídas .  
Salidas . Ways out . Sorties  
**5062137YXX** - 3 Saídas .  
Salidas . Ways out . Sorties



Duche . Ducha . Shower . Douche  
**5062147YXX**



Banheira . Bañera . Bathtub . Baignoire  
**5062115YXX**

143 >

## cores

colores . colors . couleurs



Outras cores sob consulta  
Otros colores bajo consulta  
Other colours on request  
Autres couleurs sur demande

original bathrooms since 1921

< 144



COR. COLOR  
COLEÇÃO

# LOTTO



Lavatório . Lavabo . Washbasin  
**5066222X**



Lavatório . Lavabo . Washbasin  
**5066202X**

145 >



Lavatório . Lavabo . Washbasin  
**5066232X**



Bidé . Bidet  
**5066204X**

## cores

colores . colors . couleurs

x= 2 3

**Outras cores sob consulta**  
*Otros colores bajo consulta*  
*Other colours on request*  
*Autres couleurs sur demande*

original bathrooms since 1921



Duche . Ducha . Shower . Douche  
**5066206X**



Banheira . Bañera . Bathtub . Baignoire  
**5066205X**



Duche . Ducha . Shower . Douche  
**5066207X - 1 Saída .**  
Salida . Way out . Sortie



# LOTTO



**Duche . Ducha . Shower . Douche**  
**5066277X** - 2 Saídas .  
Salidas . Ways out . Sorties  
**5066257X** - 3 Saídas .  
Salidas . Ways out . Sorties



**Cozinha . Cocina . Kitchen . Cuisine**  
**5066258X**



**Duche . Ducha . Shower . Douche**  
**5066247X**



**Banheira . Bañera . Bathtub . Baignoire**  
**5066225X**

147 >

## cores

colores . colors . couleurs

X= 2 3

**Outras cores sob consulta**  
Otras colores bajo consulta  
Other colours on request  
Autres couleurs sur demande

original bathrooms since 1921



< 148

COR . COLOR  
COULEUR

5

# FIDJI



Lavatório . Lavabo . Washbasin  
**5069582XC**



Lavatório . Lavabo . Washbasin  
**5069502X**

149 >



Lavatório . Lavabo . Washbasin  
**5069542X**



Lavatório . Lavabo . Washbasin  
**5069512X**

## cores

colores . colors . couleurs

x=

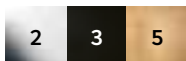

**Outras cores sob consulta**  
*Otros colores bajo consulta*  
*Other colours on request*  
*Autres couleurs sur demande*

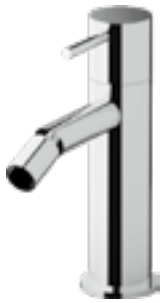

**Bidé . Bidet**  
**5069504X**



**Cozinha . Cocina .**  
**Kitchen . Cuisine**  
**5069548X**



**Duche higiénico . Ducha higiénico .**  
**Hygienic shower . Douche hygiénique**  
**5069514XC - 2 Águas . Water . Eaux**

< 150



COR . COLOR  
COULEUR



# FIDJI



Duche . Ducha . Shower . Douche  
**5069557XC** - 2 Saídas . Salidas . Ways out . Sorties  
**5069577XC** - 3 Saídas . Salidas . Ways out . Sorties



Banheira . Bañera . Bathtub . Baignoire  
**5069525XC**

151 >



Duche . Ducha . Shower . Douche  
**5069567XC** - 1 Saída . Salida . Way out . Sortie



Banheira . Bañera . Bathtub . Baignoire  
**5069555X**



Duche . Ducha . Shower . Douche  
**5069506X**



Banheira . Bañera . Bathtub . Baignoire  
**5069505X**

## cores

colores . colors . couleurs

x=

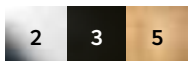

Outras cores sob consulta  
Otros colores bajo consulta  
Other colours on request  
Autres couleurs sur demande

original bathrooms since 1921



< 152

COR . COLOR  
COULEUR

3

# LINE

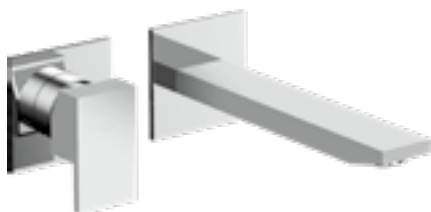

Lavatório . Lavabo . Washbasin  
**5061332X**



Lavatório . Lavabo . Washbasin  
**5061302X**

153 >



Lavatório . Lavabo . Washbasin  
**5061312X**



Bidé . Bidet  
**5061304X**

## cores

cores . colors . couleurs

x= 2 3

**Outras cores sob consulta**  
*Otros colores bajo consulta*  
*Other colours on request*  
*Autres couleurs sur demande*

original bathrooms since 1921

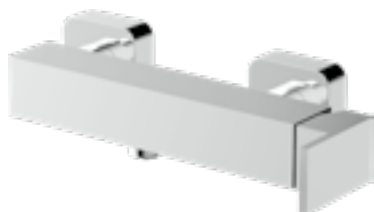

**Duche . Ducha . Shower . Douche**  
**5061306X**

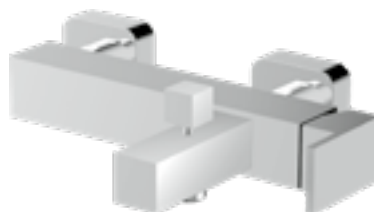

**Banheira . Bañera . Bathtub . Baignoire**  
**5061305X**

< 154



**Duche . Ducha . Shower . Douche**  
**5061307X - 1 Saída . Salida . Way out . Sortie**



**Duche . Ducha . Shower . Douche**  
**5061317X - 2 Saídas . Salidas . Ways out . Sorties**

## cores

colores . colors . couleurs

x= 2 3

**Outras cores sob consulta**  
*Otros colores bajo consulta*  
*Other colours on request*  
*Autres couleurs sur demande*

# LINE



**Duche** . *Ducha . Shower . Douche*  
**5061327X** - 2 Saídas . Salidas . Ways out . Sorties  
**5061337X** - 3 Saídas . Salidas . Ways out . Sorties



**Duche higiénico** . *Ducha higiénico . Hygienic shower . Douche hygiénique*  
**5061314X**



**Duche** . *Ducha . Shower . Douche*  
**5061367X**

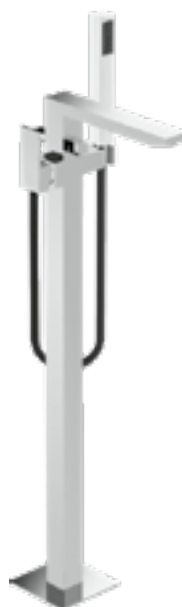

**Banheira** . *Bañera . Bathtub . Baignoire*  
**5061315X**



Lavatório . Lavabo . Washbasin  
**5063522X**



Lavatório . Lavabo . Washbasin  
**5063502X**

< 156



COR . COLOR  
COULEUR

5

# CLASSIC



Lavatório . *Lavabo . Washbasin*  
**5063531X**



Bidé . *Bidet*  
**5063504X**

157 >



Bidé . *Bidet*  
**5063534X**



Duche . *Ducha . Shower . Douche*  
**5063506X**

## cores

*cores . colors . couleurs*

x=

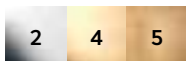

**Outras cores sob consulta**  
*Otros colores bajo consulta*  
*Other colours on request*  
*Autres couleurs sur demande*

original bathrooms since 1921



**Banheira . Bañera . Bathtub . Baignoire**  
**5063505X**



**Banheira . Bañera . Bathtub . Baignoire**  
**5063515X**

< 158





# CLASSIC



Duche . Ducha . Shower . Douche  
**5063507X** - 1 Saída . Salida . Way out . Sortie



Duche . Ducha . Shower . Douche  
**5063527X** - 2 Saídas . Salidas . Ways out . Sorties  
**5063537X** - 3 Saídas . Salidas . Ways out . Sorties

159 >



Banheira . Bañera . Bathtub . Baignoire  
**5063525X**



Duche . Ducha . Shower . Douche  
**5063547X**

## cores

colores . colors . couleurs

x=

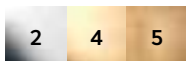

Outras cores sob consulta  
Otros colores bajo consulta  
Other colours on request  
Autres couleurs sur demande

original bathrooms since 1921



< 160

COR . COLOR  
COULEUR

3

# CAYENNE



Lavatório . *Lavabo . Washbasin*  
**5061562X**

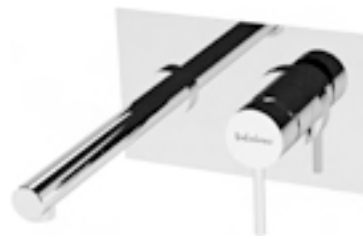

Lavatório . *Lavabo . Washbasin*  
**5061522X**

161 >



Lavatório . *Lavabo . Washbasin*  
**5061502X**



Lavatório . *Lavabo . Washbasin*  
**5061512X**

## cores

*colores . colors . couleurs*

x=

0

2

3

**Outras cores sob consulta**  
*Otros colores bajo consulta*  
*Other colours on request*  
*Autres couleurs sur demande*

original bathrooms since 1921



Lavatório . Lavabo . Washbasin  
5061582X



Bidé . Bidet  
5061504X

< 162



Duche . Ducha . Shower . Douche  
5061506X



Banheira . Bañera . Bathtub . Baignoire  
5061505X

## cores

colores . colors . couleurs

x=



Outras cores sob consulta  
Otros colores bajo consulta  
Other colours on request  
Autres couleurs sur demande

# CAYENNE



Duche . Ducha . Shower . Douche  
**5061507X** - 1 Saída . Salida . Way out . Sortie



Duche . Ducha . Shower . Douche  
**5061517X** - 2 Saídas . Salidas . Ways out . Sorties

163 >

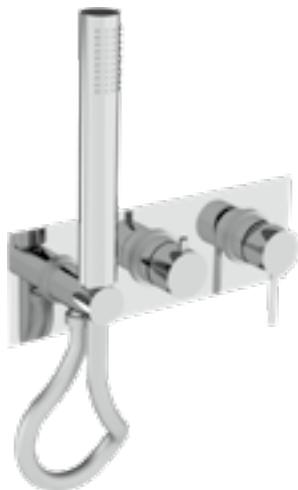

Duche . Ducha . Shower . Douche  
**5061547X** - 2 Saídas . Salidas . Ways out . Sorties  
**5061567X** - 3 Saídas . Salidas . Ways out . Sorties



Duche . Ducha . Shower . Douche  
**5062557X** - 2 Saídas . Salidas . Ways out . Sorties  
**5062577X** - 3 Saídas . Salidas . Ways out . Sorties



**Lavatório . Lavabo . Washbasin**  
**5061532X**

Para lavatório Egg Suspenso .  
Para lavabo Egg suspendido .  
For wall-hung Egg washbasin .  
Pour lavabo Egg suspendue



**Banheira . Bañera .**  
**Bathtub . Baignoire**  
**5061555X**



**Banheira . Bañera .**  
**Bathtub . Baignoire**  
**5061515X**



# CAYENNE



**Duche higiénico . Ducha higiénico .  
Hygienic shower . Douche hygiénique**  
**5061524X - 1 Água . Water . Eau**



**Duche higiénico . Ducha higiénico .  
Hygienic shower . Douche hygiénique**  
**5069100X - 2 Águas . Water . Eaux**

165 >



**Cozinha . Cocina .  
Kitchen . Cuisine**  
**5062547X**



**Cozinha . Cocina .  
Kitchen . Cuisine**  
**5061558X**

## cores

cores . colors . couleurs

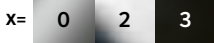

**Outras cores sob consulta**  
*Otros colores bajo consulta  
Other colours on request  
Autres couleurs sur demande*



< 166



# OLO



Lavatório . *Lavabo . Washbasin*  
**5061222X**

167 >



Lavatório . *Lavabo . Washbasin*  
**5061202X**

## cores

*colores . colors . couleurs*

x= 2



Lavatório . Lavabo . Washbasin  
**5061212X**



Bidé . Bidet  
**5061204X**

< 168



Duche . Ducha . Shower . Douche  
**5061206X**



Banheira . Bañera . Bathtub . Baignoire  
**5061205X**

## cores

colores . colors . couleurs

# OLO



**Duche . Ducha . Shower . Douche**  
**5061207X - 1 Saída . Salida . Way out . Sortie**



**Duche . Ducha . Shower . Douche**  
**5061217X - 2 Saídas . Salidas . Ways out . Sorties**

169 >



**Banheira . Bañera . Bathtub . Baignoire**  
**5061555X**



**Cozinha . Cocina . Kitchen . Cuisine**  
**5061248X**

# TERMOESTÁTICAS

termostaticos . thermostatic . thermostatiques



**Duche . Ducha . Shower . Douche**  
**5060120X**



**Banheira . Bañera . Bathtub . Baignoire**  
**5060130X**



**Duche . Ducha . Shower . Douche**  
**5061597X** - 1 Saída .  
Salida . Way out . Sortie  
**5061577X** - 2 Saídas .  
Salidas . Ways out . Sorties  
**5061587X** - 3 Saídas .  
Salidas . Ways out . Sorties

< 170

**cores**

colores . colors . couleurs

x= 2

# COLUNAS DE DUCHE

columnas de ducha . shower columns . douches avec colonne



**Duche termoestática .**  
*Ducha termostático .*  
*Thermostatic shower .*  
*Douche thermostatique*  
**5068062X** [☔ 20x20cm]  
**5068092X** [☔ 30x30cm]



**Duche termoestática .**  
*Ducha termostático .*  
*Thermostatic shower .*  
*Douche thermostatique*  
**5068032X** [☔ ø20cm]  
**5068082X** [☔ ø30cm]

171 >



**Duche . Ducha . Shower . Douche**  
**5068061X** [☔ 20x20cm]  
**5068071X** [☔ 30x30cm]



**Duche . Ducha . Shower . Douche**  
**5068031X** [☔ ø20cm]  
**5068051X** [☔ ø30cm]



< 172

# SENSOR



Lavatório . *Lavabo . Washbasin*  
**5060202X** - [220V]



Lavatório . *Lavabo . Washbasin*  
**5060203X** - [220V]



Lavatório . *Lavabo . Washbasin*  
**5060204X** - [220V]

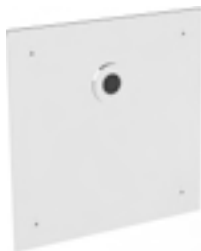

Urinol . *Urinario . Urinal . Urinoir*  
**5060206X** - [220V]



Urinol . *Urinario . Urinal . Urinoir*  
**5060205X** - [6V]

173 >

**cores**

*cores . colors . couleurs*





# TEMPORIZADAS

temporizados . timer taps . temporisés



Lavatório . Lavabo . Washbasin  
**5066711X**



Lavatório . Lavabo . Washbasin  
**5068202X**



Lavatório . Lavabo . Washbasin  
**5060951X**



Lavatório . Lavabo . Washbasin  
**5060901X**



Lavatório . Lavabo . Washbasin  
**5060961X**



Lavatório . Lavabo . Washbasin  
**5060971X**

175 >

## cores

colores . colors . couleurs



Duche . Ducha . Shower . Douche  
**5060907X**  
Urinol . Urinario . Urinal . Urinoir  
**5060919X**



Duche . Ducha . Shower . Douche  
**5060917X - 2 Águas . Water . Eaux**

< 176



Duche . Ducha . Shower . Douche  
**5066709X - 2 Águas . Water . Eaux**



Duche . Ducha . Shower . Douche  
**5060900X**

## cores

colores . colors . couleurs

# TEMPORIZADAS

temporizados . timer taps . temporisés



**Sanita . Inodoro . Toilet . Toilette**  
**5060918X**



**Sanita . Inodoro . Toilet . Toilette**  
**5060908X**  
**5060928X - Regulável . Adjustable**

177 >



**Urinol . Urinario . Urinal . Urinoir**  
**5060929X**



**Urinol . Urinario . Urinal . Urinoir**  
**5060939X**

*Valadares*

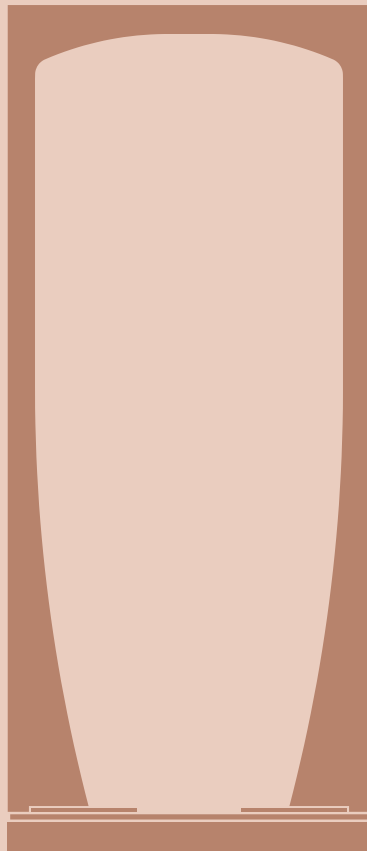

# ESPAÇOS PÚBLICOS

ESPACIOS PÚBLICOS . PUBLIC SPACES . ESPACES PUBLICS

 PMR

*p. 180 - 185*

## URINÓIS

URINARIOS . URINALS . URINOIRS

*p. 186 - 189*

## JUNIOR

*p. 190 - 191*

## PEÇAS TÉCNICAS

PIEZAS TÉCNICAS . TECHNICAL PIECES . PIÉCES TECHNIQUES

*p. 192 - 193*





# PMR



181 >

COR. COLOR  
COULEUR  
**00**

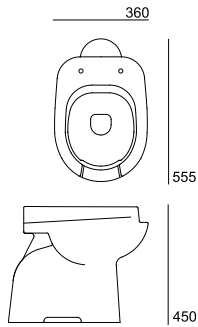

**Sanita . Inodoro . Toilet . Toilette**  
**18063002K**  
**Tanque . Cistern . Réservoir**  
**33182002**  
**Tampo . Tapa . Cover . Abattant**  
**50221000 [CM]**

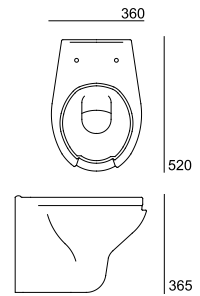

**Sanita . Inodoro . Toilet . Toilette**  
**18003002K**  
**Tampo . Tapa . Cover . Abattant**  
**50261000 [CM]**

< 182

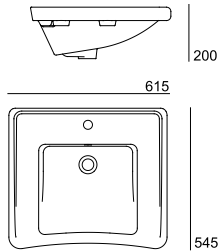

**Gaia Lavatório . Lavabo . Washbasin**  
**78781002C**

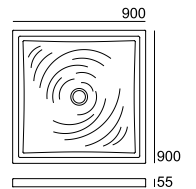

**Aqua base chuveiro . Plato de Ducha . Shower Tray . Receveur de Douche**  
**78639002K**



**Suporte regulável . Suporte regulable . Fixed support w/ pre-adjust . Support ajustable**  
**55089000**



**Suporte basculante . Washbasin lift support . Support éleveur de lavabo**  
**55025000**





# PMR



**Apoio sanita . Apoyo inodoro .**  
*Toilet support . Support toilette*

**5514009X**   
**5514010X**

x= 0 3 8



**Apoio sanita . Apoyo inodoro .**  
*Toilet support . Support toilette*

**5514014X**

x= 0 3 8



**Apoio sanita . Apoyo inodoro .**  
*Toilet support . Support toilette*

**5514012X**   
**5514013X**   
**5514002X**   
**5514003X**

x= 0 3 8



**Apoio lavatório . Apoyo lavabo .**  
*Washbasin support . Support lavabo*

**5514007X**   
**5514008X**

x= 0 3 8



**Apoio . Apoyo . Support**  
**5514017X**

x= 0 3 8



**Apoio . Apoyo . Support**

**5514006X** [80cm]  
**5514001X** [60cm]  
**5514005X** [50cm]  
**5514004X** [40cm]

x= 0 3 8



Lavatório . Lavabo . Washbasin  
**5066300X**

x= 0



Style Lavatório . Lavabo . Washbasin  
**5066302X**

x= 2 3



Duche . Ducha . Shower . Douche  
**5068002X**

x= 2



Style Duche . Ducha . Shower . Douche  
**5066304X**

x= 2 3



Duche . Ducha . Shower . Douche  
**5068001X**

x= 2



Style Banheira . Bañera . Bathtub . Baignoire  
**5066303X**

x= 2 3



# PMR



Lavatório . *Lavabo . Washbasin*  
**5068201X**

x= 2



Lavatório . *Lavabo . Washbasin*  
**5066713X**

x= 2

185 >



Duche . *Ducha . Shower . Douche*  
**5505901X**

x= 0 3 8



Espelho basculante . *Espejo basculante .  
Adjustable mirror . Miroir réglable*  
**5098902X** [58x73cm]  
**5098901X** [40x73cm]

x= 0 3 8



# URINÓIS

urinarios . urinals . urinoirs



187 >

COR. COLOR  
COULEUR

47



**Orbital**  
**78560XX2K**

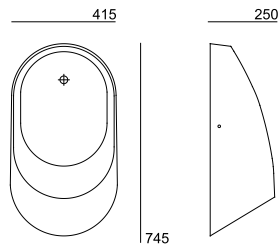

**Kino**  
**78530XX2K**

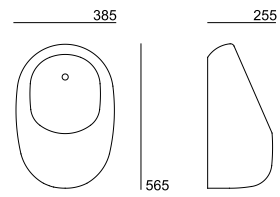

< 188



**Canto**  
**18550XX2K**

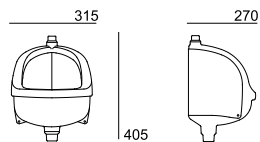

**Flórida**  
**18510XX2K**

[Alim. Superior . Top Inlet . Alim. Supérieure]

**18511XX2K**

[Alim. Traseira . Back Inlet . Alim. Arrière]

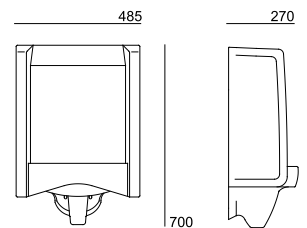

## cores

cores . colors . couleurs

xx= 00 48

**Outras cores sob consulta**  
Otros colores bajo consulta  
Other colours on request  
Autres couleurs sur demande

# URINÓIS

urinaros . urinals . urinoirs

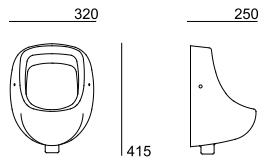

**Face**  
**18540XX2K**  
[Alim. Superior . Top Inlet . Alim. Supérieure]  
**18541XX2K**  
[Alim. Traseira . Back Inlet . Alim. Arrière]

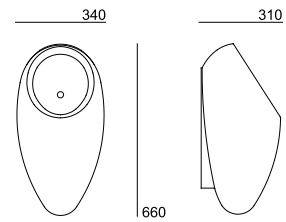

**Egg**  
**39530XX2K**

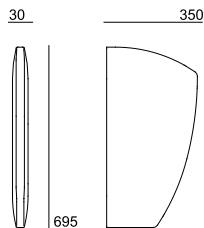

**Separador . Separator . Séparateur**  
**78924XX2K**

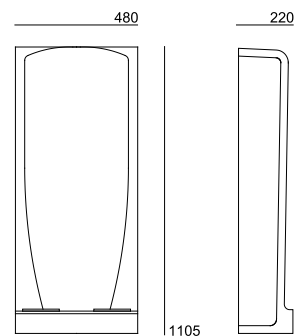

**Niagara**  
**18520XX2K**  
[Alim. Superior . Top Inlet . Alim. Supérieure]  
**18521XX2K**  
[Alim. Traseira . Back Inlet . Alim. Arrière]



< 190

## cores

colores . colors . couleurs

xx= 00 48

Tamos . Tapas .  
Covers . Abattants

00 51 52 53 54



# JÚNIOR

niños . children . enfantin



COR . COLOR  
COULEUR

00



Sanita . Inodoro . Toilet . Toilette  
**18651XX2KV**  
**18651XX2KH**

Sanita suspensa . Inodoro suspendido .  
Wall-hung toilet . Toilette suspendue  
**18651XX2KS**

Tampo . Tapa . Cover . Abbatant  
**50259XX0 [CM]**

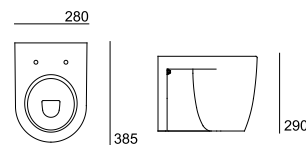

191 >



Lavatório . Lavabo . Washbasin  
**18601XX2C**

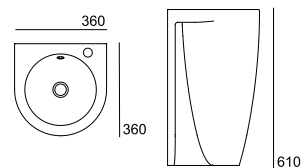

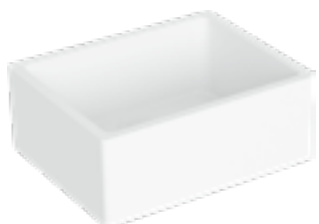

**Pia Sintra** . *Piła Sintra* .  
*Sintra Sink* . *Évier Sintra*  
**78615XX2C**

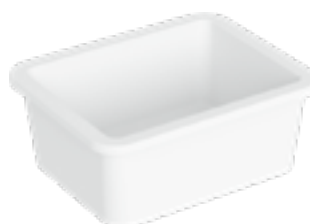
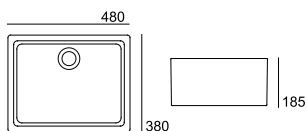

**Pia Silves** . *Piła Silves* .  
*Silves Sink* . *Évier Silves*  
**78616XX2C**

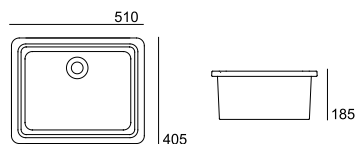

< 192



**Pia hospitalar** . *Piła vertedero* .  
*Medical slop hooper* . *Évier d'hôpital*  
**18613XX2K**

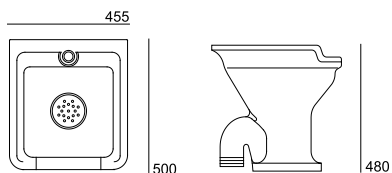

**Grade inox** . *Rejilla cromada para vertedero* .  
*Stainless steel grid* . *Grille en acier inoxydable*  
**55003001**

## cores

*colores . colors . couleurs*

xx= 00

# PEÇAS TÉCNICAS

piezas técnicas . technical pieces . pièces techniques

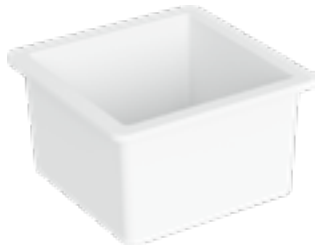

**Pia Monchique . Pila Monchique .  
Monchique Sink . Évier Monchique**  
**78618XX2C**

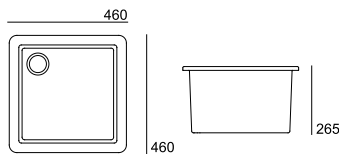

**Pia de despejo . Pila de descarga .  
Discharge sink . Évier de décharge**  
**18614XX2C**

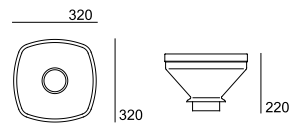

**Lava-roupa Mozela . Lavadero Mozela .  
Mozela washer . Lave-linge Mozela**  
**78660XX2C**

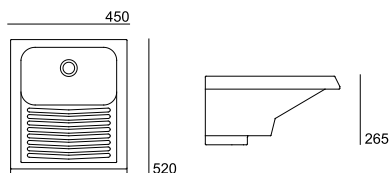

**Móvel Mozela . Mueble Mozela .  
Mozela furniture . Meuble Mozela**  
**55332010**

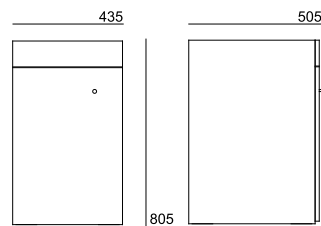

193 >

# Valadares

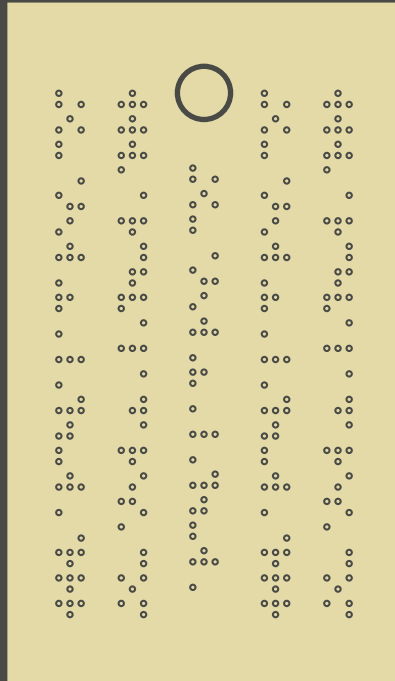

# BASES DE CHUVEIRO

PLATOS DE DUCHA . SHOWER TRAYS . RECEVEURS DE DOUCHE

## CERÂMICAS

EN CERÁMICA . CERAMICS . CÉRAMIQUES

*p. 196 - 199*

## RESINA CARGA MINERAL

RESIN MINERAL CHARGE  
RÉSINE CHARGE MINÉRALE

*p. 200 - 201*



< 196

CDR. COLOR  
COULEUR

10

# CERÂMICAS

en cerámica . ceramics . céramiques

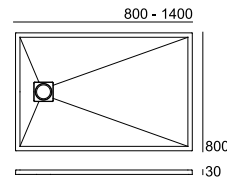

## Flow

|                  |              |
|------------------|--------------|
| <b>78686XX2K</b> | [140x80x3cm] |
| <b>78684XX2K</b> | [120x80x3cm] |
| <b>78683XX2K</b> | [110x80x3cm] |
| <b>78682XX2K</b> | [100x80x3cm] |
| <b>78681XX2K</b> | [90x80x3cm]  |
| <b>78680XX2K</b> | [80x80x3cm]  |

197 >

**HIGHPOR® - CERÂMICA ANTIDERRAPANTE . HIGHPOR® - REVESTIMIENTO CERÁMICO ANTIDESLIZANTE .**  
**HIGHPOR® - NON-SLIP CERAMIC COATING . HIGHPOR® - CÉRAMIQUE ANTIDÉRAPANTE EN HIGHPOR**



**Resistência às manchas .**  
*Resistencia a las manchas .*  
*Stain resistance .*  
*Résistance aux taches*



**Fácil limpeza .**  
*Fácil limpieza .*  
*Easy cleaning .*  
*Nettoyage facile*



**Resistência ao fogo .**  
*Resistente al fuego .*  
*Fire resistance .*  
*Résistance au feu*



**Resistência ao ataque químico .**  
*Resistencia al ataque químico .*  
*Resistance to chemical attack .*  
*Résistance aux attaques chimiques*

**Base 100% cerâmica e reciclável .**  
*Plato de ducha 100% cerámica y reciclable .*  
*100% ceramic and recyclable shower tray .*  
*Receveur de douche 100% céramique et recyclable*

**Fácil escoamento e instalação .**  
*Excelente flujo y facilidad de instalación .*  
*Excellent flow and ease of installation .*  
*Écoulement et installation facile*

**Revestimento cerâmico antiderrapante - Classe C**  
*Revestimiento cerámico antideslizante - Clase C .*  
*Non-slip ceramic coating - Class C .*  
*Revêtement céramique antidérapant - Class C*

## cores

*colores . colors . couleurs*

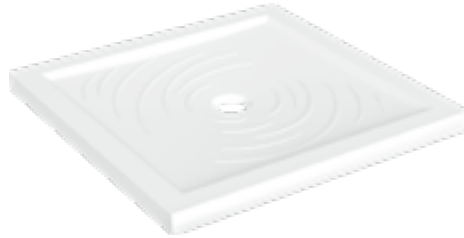

**Aqua**  
**78639XX2K**

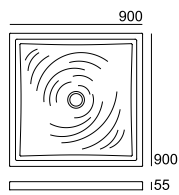

**Douro Plus**  
**78670XX2K**

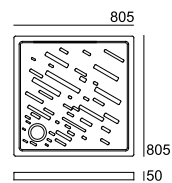

**Egg**  
**39673XX2K**

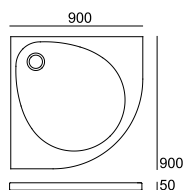

< 198



# CERÂMICAS

en cerámica . ceramics . céramiques



**Luca**  
**78672XX2K** [140x80x5cm]  
**78671XX2K** [140x70x5cm]

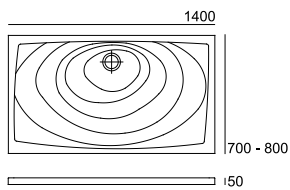

**Berna**  
**78674XX2K** [130x80x4cm]  
**78673XX2K** [130x75x4cm]

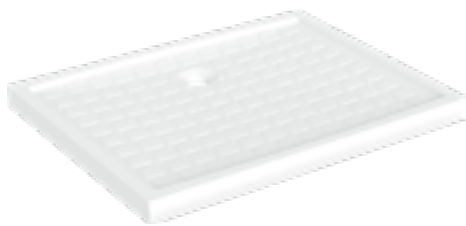
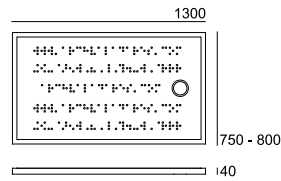

**Lusa**  
**78632XX2K**

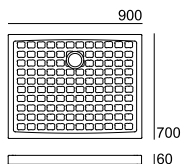

**Danilo**  
**78631XX2K**

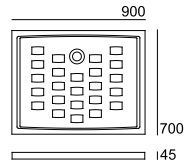

**Pádua**  
**78636XX2K** [120x80x5cm]  
**78635XX2K** [100x80x5cm]

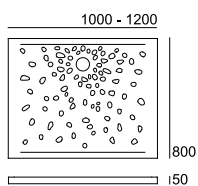

**Aris**  
**78634XX2K** [120x70x4cm]  
**78633XX2K** [100x70x4cm]

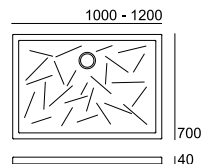

199 >



# RESINA CARGA MINERAL

resin mineral charge . résine charge minérale

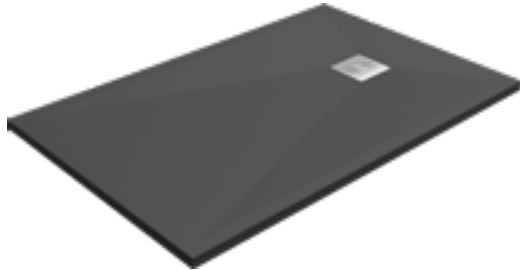

## Iko Slate

Disponível em vários tamanhos (consultar tabela de preços) .  
 Disponible en varios tamaños (ver tarifa de precios) .  
 Available in various sizes (see prices list) .  
 Disponible en différentes tailles (voir liste de prix)

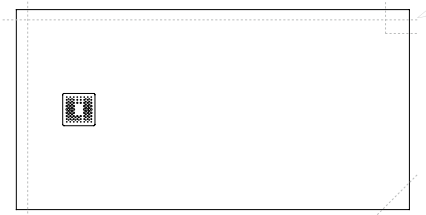

Versatilidade no corte para adaptação a qualquer medida e espaço .  
 Versatilidad en el ajuste para adaptarse a cualquier tamaño y espacio .  
 Versatility in the cut to adapt to any measure and space .  
 Polyvalence dans la coupe pour s'adapter à toutes les tailles et espaces

|  |     | Comprimento . Longitud . Length . Longueur<br>(cm) - A |    |    |     |     |     |     |     |     |     |     |     |     |     | Espessura . Grosor .<br>Thickness . Epaisseur<br>(cm) 2,5 - 2,8 |     |
|--|-----|--|----|----|-----|-----|-----|-----|-----|-----|-----|-----|-----|-----|-----|---|-----|
|  |     | 70   | 80 | 90 | 100 | 110 | 120 | 130 | 140 | 150 | 160 | 170 | 180 | 190 | 200 |   | 210 |
| Largura . Ancho .<br>Width . Largeur<br>(cm) - B | 70  | 35   | 35 | 35 | 35  | 45  | 45  | 45  | 45  | 45  | 45  | 45  | 45  | 45  | 45  | 45  | 45  |
|  | 75  | -  | 35 | 35 | 35  | 45  | 45  | 45  | 45  | 45  | 45  | 45  | 45  | 45  | 45  | 45  | 45  |
|  | 80  | -  | 40 | 35 | 35  | 45  | 45  | 45  | 45  | 45  | 45  | 45  | 45  | 45  | 45  | 45  | 45  |
|  | 90  | -  | -  | 35 | 35  | 45  | 45  | 45  | 45  | 45  | 45  | 45  | 45  | 45  | 45  | 45  | 45  |
|  | 100 | -  | -  | -  | 35  | 45  | 45  | 45  | 45  | 45  | 45  | 45  | 45  | 45  | 45  | 45  | 45  |
| 120  | -   | -  | -  | -  | -   | 45  | 45  | 45  | 45  | 45  | 45  | 45  | 45  | 45  | 45  | 45  |     |

Distância lateral ao centro da válvula . Distancia lateral al centro de la válvula .  
 Lateral distance to the center of the valve . Distance latérale au centre de la vanne  
 (cm) - C (+/- 2% tolerância . tolerancia . tolerance . tolérance)

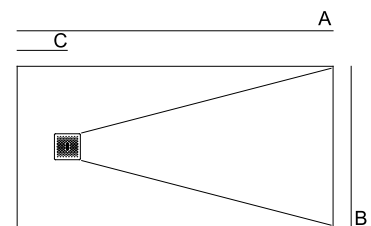

201 >

### Acabamento:

Gel coat sanitário nas cores indicadas aplicado por termofusão com o corpo da base de chuveiro. Antiderrapante e antibacteriano.

### Garantia:

3 anos contra defeitos de fabrico.

### Refinamiento:

Gel coat sanitario en los colores indicados aplicado por termofusión con el cuerpo del plato de ducha. Antideslizante y antibacteriano.

### Garantizar:

3 años contra defectos de fabricación.

### Finishing:

Sanitary gel coat in the indicated colors applied by thermofusion with the shower tray body. Non-slip and antibacterial.

### Guarantee:

3 years against manufacturing defects.

### Finition:

Gelcoat sanitaire dans les couleurs indiquées appliqué par thermofusion avec le corps du receveur de douche. Antidérapant et antibactérien.

### Garantie:

3 ans contre les défauts de fabrication.

## CORES . COLORES . COLORS . COULEURS

|          |                                     |
|----------|-------------------------------------|
| RAL 9003 | BRANCO . BLANCO . WHITE . BLANC     |
| RAL 7004 | CINZA . GRIS . GREY . GRISE         |
| RAL 1013 | AREIA . ARENA . SAND . SABLE        |
| RAL 7026 | ARDÓSIA . PIZARRA . SLATE . ARDOISE |
| RAL 9005 | PRETO . NEGRO . BLACK . NOIR        |

*Valadares*

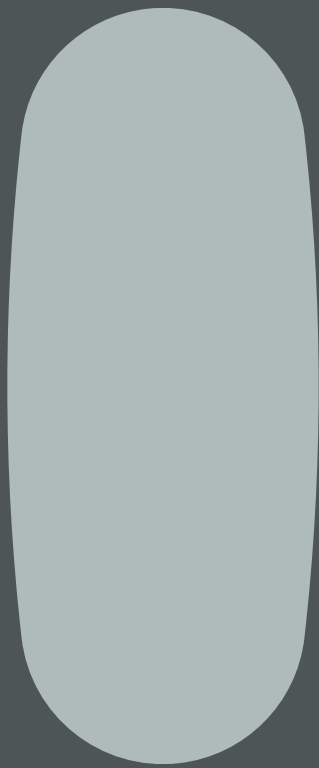

# BANHEIRAS

BAÑERAS . BATHTUBS . BAIGNOIRES

EGG

*p. 206*

ZEN

*p. 206*

LIGHT

*p. 207*

LUX

*p. 207*

STAR

*p. 206*

CLASSIC

*p. 206*

ARTIC

*p. 207*

BALTIC

*p. 207*



# BANHEIRAS

bañeras . bathtubs . baignoires

205 >

COB . COLOR  
COULEUR

00



**Egg**  
**52100000**

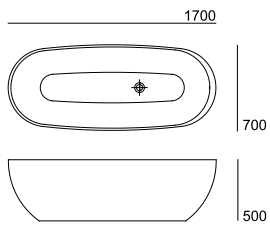

**Zen**  
**51100204**

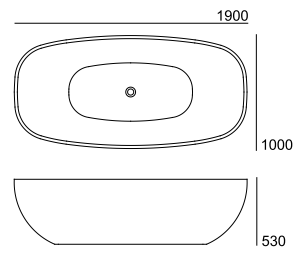

< 206



**Star**  
**51100201**

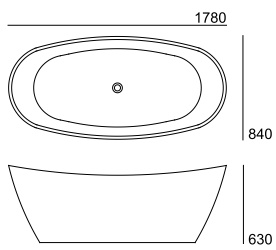

**Classic**  
**51100002** [175x82cm]  
**51100001** [168x76cm]

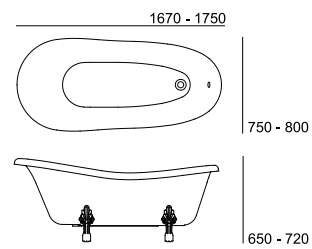



# BANHEIRAS

bañeras . bathtubs . baignoires



## Light

**51200005** [170x75cm]

**51200004** [155x75cm]

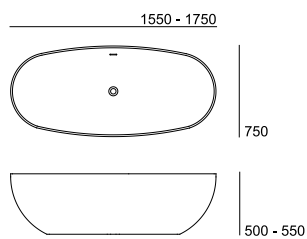

## Lux

**51100202**

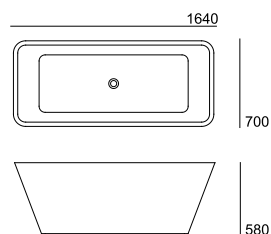

207 >



## Artic

**51614000** [190x90cm]

**51613000** [180x80cm]

**51612000** [170x75cm]

**51611000** [170x70cm]

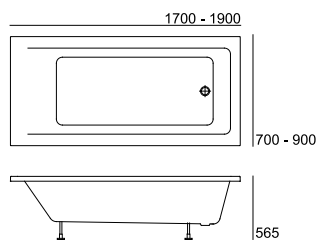

## Baltic

**51627000** [175x70cm]

**51626000** [170x75cm]

**51625000** [170x70cm]

**51624000** [160x75cm]

**51623000** [160x70cm]

**51622000** [150x70cm]

**51621000** [140x70cm]

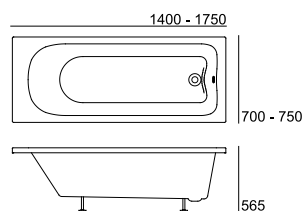

## ARTIC | BALTIC

Accesórios vendidos à parte, para mais informação consultar tabela de preços .  
Los accesorios se venden por separado, para más información ver tarifa de precios .  
Accessories sold separately, for more information see price list .  
Accessoires vendus séparément, pour plus d'informations, voir la liste de prix

# Valadares

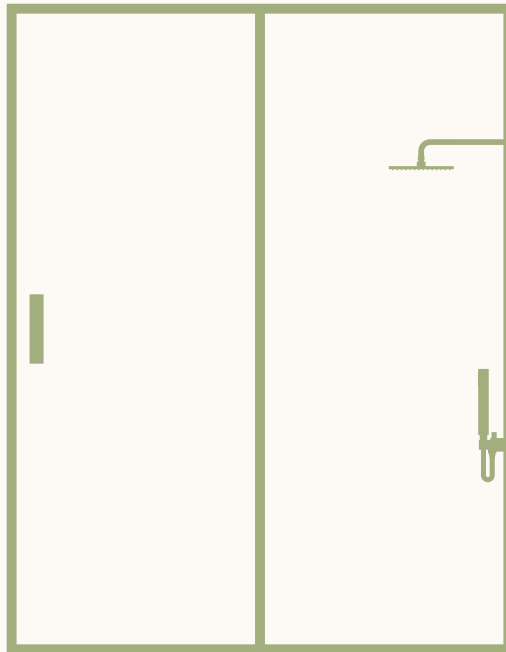

# RESGUARDOS

MAMPARAS . SHOWER CABINS . PANNEAUX DOUCHE

OPALA

*p. 210*

RUBI

*p. 211*

SPLASH

*p. 212*

PURA

*p. 213*

EGG

*p. 213*



**Opala Frontal . Front**

**52762072D**

[1401-1600 Dir . Right . Droit]

**52762072E**

[1401-1600 Esq . Izq . Left . Gauche]

**52762062D**

[1201-1400 Dir . Right . Droit]

**52762062E**

[1201-1400 Esq . Izq . Left . Gauche]

**52762052D**

[1000-1200 Dir . Right . Droit]

**52762052E**

[1000-1200 Esq . Izq . Left . Gauche]

Vidro temperado de 8mm (vidro de correr) e de 10mm (vidro fixo).  
 Altura de 1950mm.  
 Componentes em aço inox.  
 Painel frontal min. 1000mm até máx 1600mm.  
 Painel Lateral até 800mm (outras medidas sob consulta)

*8mm tempered glass (sliding glass) and 10mm (fixed glass).  
 Height of 1950mm.  
 Stainless steel components.  
 Front panel min. 1000mm up to max 1600mm.  
 Side Panel up to 800mm (other measures on request)*



**Opala Canto . Corner . Coin**

**52762102D**

[1401-1600x800 Dir . Right . Droit]

**52762102E**

[1401-1600x800 Esq . Izq . Left . Gauche]

**52762092D**

[1201-1400x800 Dir . Right . Droit]

**52762092E**

[1201-1400x800 Esq . Izq . Left . Gauche]

**52762082D**

[1000-1200x800 Dir . Right . Droit]

**52762082E**

[1000-1200x800 Esq . Izq . Left . Gauche]

Vidro templado de 8mm (vidrio corredizo) y 10mm (vidrio fijo).  
 Altura de 1950mm.  
 Componentes de acero inoxidable.  
 Panel frontal mín. 1000 mm hasta un máximo de 1600 mm.  
 Panel Lateral hasta 800mm (outras medidas bajo pedido)

*Verre trempé 8mm (verre coulissant) et 10mm (verre fixe).  
 Hauteur de 1950 mm.  
 Composants en acier inoxydable.  
 Panneau avant min. 1000 mm jusqu'à 1600 mm maximum.  
 Panneau latéral jusqu'à 800 mm (autres mesures sur demande)*

# RESGUARDOS

mamparas . shower cabins . panneaux douche



**Rubi Frontal** . *Front*

**52762022D**

[801-1000 Dir . Right . Droit]

**52762022E**

[801-1000 Esq . Izq . Left . Gauche]

**52762012D**

[640-800 Dir . Right . Droit]

**52762012E**

[640-800 Esq . Izq . Left . Gauche]



**Rubi Canto** . *Corner . Coin*

**52762042D**

[801-1000x800 Dir . Right . Droit]

**52762042E**

[801-1000x800 Esq . Izq . Left . Gauche]

**52762032D**

[640-800x800 Dir . Right . Droit]

**52762032E**

[640-800x800 Esq . Izq . Left . Gauche]

211 >

Vidrio temperado de 6mm

Altura de 1950mm.

Perfis em alumínio cromados.

Painel Frontal mín. 640mm mín. Até máx. 1000mm.

Painel Lateral máx. 800mm. (outras medidas sob consulta)

*6mm tempered glass*

*Height of 1950mm.*

*Chromed aluminum profiles.*

*Front Panel min. 640mm min. Up to max. 1000mm.*

*Side panel max. 800mm. (other measures on request)*

*Vidrio templado de 6 mm*

*Altura de 1950mm.*

*Perfiles de aluminio cromado.*

*Panel frontal mín. 640 mm mín. Hasta máx. 1000 mm.*

*Panel lateral máx. 800 mm. (outras medidas bajo pedido)*

*Verre trempé de 6 mm*

*Hauteur de 1950 mm.*

*Profils en aluminium chromé.*

*Panneau avant min. 640 mm min. Jusqu'à max. 1000mm.*

*Panneau latéral max. 800 mm. (autres mesures sur demande)*



< 212



**Splash Frontal . Front**

- 52763162** [160cm]
- 52763152** [150cm]
- 52763142** [140cm]
- 52763132** [130cm]
- 52763122** [120cm]
- 52763112** [110cm]
- 52763102** [100cm]

**Splash Painel Lateral Fixo . Panel lateral fijo .**  
*Fixed side panel . Panneau latéral fixe*

- 52763192** [90cm]
- 52763182** [80cm]
- 52763172** [70cm]

**Splash Canto . Corner . Coin**

- 52763052** [120 | 118,5 - 120cm]
- 52763042** [100 | 98,5 - 100cm]
- 52763032** [90 | 88,5 - 90cm]
- 52763022** [80 | 78,5 - 80cm]
- 52763012** [75 | 73,5 - 75cm]
- 52763002** [70 | 68,5 - 70cm]

Vidro temperado 6mm com tratamento anticalcário.  
 Altura de 2000mm.  
 Perfis de alumínio cromado.  
 Dobradiças em inox.

*6mm tempered glass with anti-lime treatment.  
 2000mm height.  
 Chromed aluminum profiles.  
 Stainless steel hinges.*

Vidro templado de 6mm con tratamiento antical.  
 2000 mm de altura.  
 Perfiles de aluminio cromado.  
 Bisagras de acero inoxidable.

*Verre trempé 6 mm avec traitement anti-calcaire.  
 Hauteur 2000 mm.  
 Profilés en aluminium chromé.  
 Charnières en acier inoxydable.*

# RESGUARDOS

mamparas . shower cabins . panneaux douche



## **Pura**

**120 Painel . Panel . Panneau**  
**52763232**

**100 Painel . Panel . Panneau**  
**52763222**

**90 Painel . Panel . Panneau**  
**52763212**

**80 Painel . Panel . Panneau**  
**52763202**

Vidro temperado de 8mm com tratamento anticalcário.  
Altura 2000mm.  
Perfis em alumínio cromado.  
Extensor de suporte em aço inox.  
Painel com perfilaria reversível.

*Vidrio templado de 8mm con tratamiento antical.  
Altura 2000mm.  
Perfiles de aluminio cromado.  
Extensor de soporte de acero inoxidable.  
Panel con perfil reversible.*

*8mm tempered glass with anti-lime treatment.  
Height 2000mm.  
Chromed aluminum profiles.  
Stainless steel support extender.  
Panel with reversible profile.*

*Verre trempé 8 mm avec traitement anti-calcaire.  
Hauteur 2000mm.  
Profils en aluminium chromé.  
Prolongateur de support en acier inoxydable.  
Panneau avec profil réversible.*



## **Egg 90**

**52750201**

Frontal angular com dois painéis fixos e duas portas de correr.  
Vidro temperado 4mm.  
Altura 1850mm.  
Perfis em alumínio metalizado.  
Rolamentos em inox.

*Panel frontal en ángulo con dos paneles fijos y dos puertas correderas.  
Cristal templado de 4 mm.  
Altura 1850mm.  
Perfiles de aluminio metalizado.  
Cojinetes de acero inoxidable.*

*Angled front panel with two fixed panels and two sliding doors.  
4mm tempered glass.  
Height 1850mm.  
Metallized aluminum profiles.  
Stainless steel bearings.*

*Façade inclinée avec deux panneaux fixes et deux portes coulissantes.  
Verre trempé 4 mm.  
Hauteur 1850mm.  
Profils en aluminium métallisé.  
Roulements en acier inoxydable.*

213 >

*Valadares*





# ACESSÓRIOS CERÂMICOS

ACCESORIOS CERÁMICA . CERAMIC ACCESSORIES . ACCESSOIRES CÉRAMIQUES

BLEND

*p. 216 - 217*

NEOCLÁSSICO

*p. 218 - 219*

ALFA

*p. 220 - 221*



**Cabide** . *Percha . Hanger . Patère*  
**24001XX2**



**Porta-piaçaba** . *Escobillero . Toilet brush holder . Porte-balayette*  
**24100XX2**

< 216



**Saboneteira Pequena** . *Jabonera pequeña . Small soap tray . Porte-savon petit*  
**24400XX2**



**Saboneteira Grande** . *Jabonera grande . Large soap tray . Porte-savon grand*  
**24401XX2**

## cores

*colores . colors . couleurs*

xx= 00

**Outras cores sob consulta**  
*Otros colores bajo consulta*  
*Other colours on request*  
*Autres couleurs sur demande*

# BLEND



**Vassoura** . Escobilla . Brush . Brosse  
**55020005**



**Porta-roló** . Portarollo .  
Toilet paper holder . Porte-papier  
**24200XX2**

217 >



**Prateleira** . Estante . Shelf . Étagère  
**24350XX2**



**Toalheiro** . Toallero .  
Porcelain towel rail . Porte-Serviettes  
**24540XX2** [40cm]  
**24530XX2** [30cm]



**Cabide** . *Percha . Hanger . Patère*  
**26001XX2**



**Porta-piaçaba** . *Escobillero . Toilet brush holder . Porte-balayette*  
**26100XX2**

< 218



**Saboneteira Pequena** . *Jabonera pequeña . Small soap tray . Porte-savon petit*  
**26400XX2**



**Saboneteira Grande** . *Jabonera grande . Large soap tray . Porte-savon grand*  
**26404XX2**

## cores

*colores . colors . couleurs*

xx= 00

**Outras cores sob consulta**  
*Otros colores bajo consulta*  
*Other colours on request*  
*Autres couleurs sur demande*

# NEOCLÁSSICO



**Vassoura** . Escobilla . Brush . Brosse  
**55020005**



**Porta-rollo** . Portarollo .  
Toilet paper holder . Porte-papier  
**26200XX2**

219 >



**Toalheiro** . Toallero .  
Porcelain towel rail . Porte-Serviettes  
**22660XX2** [60cm]  
**22650XX2** [50cm]  
**22640XX2** [40cm]  
**22630XX2** [30cm]

**Suporte** . Soporte . Bracket . Support  
**26500XX2**



**Cabide** . *Percha . Hanger . Patère*  
**22001XX2**



**Porta-piaçaba** . *Escobillero . Toilet brush holder . Porte-balayette*  
**22100XX2**

< 220



**Saboneteira Pequena** . *Jabonera pequena . Small soap tray . Porte-savon petit*  
**22400XX2**



**Saboneteira Esponjeira** . *Jabonera empotrada . Soap tray and sponge tray . Porte-savon et porte-éponge*  
**22401XX2**

## cores

*colores . colors . couleurs*

xx= 00

**Outras cores sob consulta**  
*Otros colores bajo consulta*  
*Other colours on request*  
*Autres couleurs sur demande*

# ALFA



**Vassoura** . Escobilla . Brush . Brosse  
**55020005**



**Porta-roló** . Portarollo .  
Toilet paper holder . Porte-papier  
**22200XX2**

221 >



**Prateleira** . Estante . Shelf . Étagère  
**22360XX2**



**Toalheiro** . Toallero .  
Porcelain towel rail . Porte-Serviettes  
**22660XX2** [60cm]  
**22650XX2** [50cm]  
**22640XX2** [40cm]  
**22630XX2** [30cm]  
**Suporte** . Soporte . Bracket . Support  
**22500XX2**





# CONDIÇÕES GERAIS DE VENDA

CONDICIONES GENERALES DE VENDA . GENERAL CONDITIONS OF SALE . CONDITIONS GÉNÉRALES DE VENTE



ENDEREÇO TELEGRÁFICO

23 - Rua de Coimbra  
1 - Porto - 4111  
de Lisboa C 2167

CERÁMICA VALADARES

23 - Rua de Coimbra  
1 - Porto - 4111  
de Lisboa C 2167  
VALADARES  
V. N. DE GAYA

azulejo e outros Tijolos ver **EXIGIR ESTA MARCA**  
artefactos diversos. Tubos de Gres e acanalicados  
Alho e Coimbra. Artigos sanitários. Azulejos  
e peças decorativas.

original bathrooms since 1921

# CONDIÇÕES GERAIS DE VENDA

## INTRODUÇÃO

Todas as relações comerciais entre a ARCH, SA e os seus Clientes são reguladas pelas seguintes “condições gerais de venda” que conjuntamente com as “condições gerais de pagamento” consideram-se integralmente aceites pelo comprador no ato da encomenda.

## 1. Catálogos, ofertas e encomendas

- 1.1. Todas as indicações e características constantes do material publicitário e informativo estão sujeitas às tolerâncias definidas pelas normas de regulamentação interna de acordo com o normativo do setor.
- 1.2. Qualquer encomenda realizada à ARCH, SA deverá ser realizada em formato escrito, com devida identificação do Cliente, data e descrição técnica suportada nas nossas referências de artigo.
- 1.3. Todas as encomendas serão, para todos os efeitos, passíveis de confirmação por escrito por parte do Cliente.
- 1.4. Qualquer condição estipulada pelo Cliente nos seus pedidos e que não esteja em conformidade com as presentes “condições gerais de Venda” bem como “condições gerais de Pagamento” serão consideradas sem efeito, com posterior confirmação escrita, pela ARCH, SA.

## 2. Suspensão das Encomendas

- 2.1. A ARCH, SA reserva o direito de suspender a execução de qualquer encomenda nos seguintes casos:
  - Quando o Cliente não tiver dado cumprimento parcial ou total a contratos anteriores;
  - Quando por parte do Cliente se verificar recusa na recepção de encomendas após carga e expedição conforme prévia encomenda,
  - Sempre que se verifique conduta indevida do Cliente em prejuízo da ARCH, SA.

## 3. Entregas

- 3.1. Os prazos de entrega são acordados entre a ARCH, SA e o Cliente no decurso da encomenda. Se nada for formalmente estipulado entre as partes, o prazo de referência para entrega será de 30 dias úteis. Sempre que não for possível garantir um prazo acordado, a ARCH, SA compromete-se a avisar o Cliente e a combinar um novo prazo.
- 3.2. Toda e qualquer encomenda poderá ser executada por entregas parciais.
- 3.3. Os artigos e mercadorias consideram-se entregues ao Cliente no momento da carga do meio de transporte deste e a respectiva guia de remessa assinada pelo operador do transporte quando este é da responsabilidade do Cliente. Nestes casos não serão aceites reclamações posteriores por faltas ou dano em mercadoria entregue.
- 3.4. Sempre que a mercadoria é entregue em transporte da responsabilidade da ARCH, SA, esta considera-se entregue quando da validação de recepção de mercadoria no destinatário.
- 3.5. O acto de recepção da mercadoria por parte do Cliente implica a confirmação do conteúdo e conformidade da mesma de acordo com encomenda efectuada e/ou com documentos comprovativos de transporte. Qualquer anomalia deverá ser registada em Guia de remessa da ARCH, SA bem como na Guia de transporte.
- 3.6. Caso não seja possível verificar mercadoria no momento da entrega, o Cliente deverá assinalar nas Guias de Remessa e Transporte a referência “Sujeito a conferência”. Qualquer anomalia verificada deverá ser comunicada por escrito pelo Cliente aos nossos serviços comerciais em tempo útil e nunca superior a 5 dias úteis à data da recepção da mercadoria.
- 3.7. A ARCH, SA poderá recusar-se a efectuar o transporte de mercadoria sempre que :
  - O local de destino não seja o armazém do Cliente ou local definido no momento da encomenda.
  - O volume da encomenda não o justifique
  - Sempre que houver recusa de recepção de mercadoria sem motivos imputáveis à ARCH, SA, sendo nesse caso debitado ao Cliente o valor relativo ao transporte e a custos adicionais decorrentes dessa condição.
  - A ARCH, SA reserva-se o direito de considerar sem efeito toda a encomenda que aguarde mais de 30 dias após sua execução nas nossas instalações, sem que o Cliente proceda ao seu levantamento.

## 4. Preços

- 4.1. Os preços praticados são os constantes da tabela de preços da ARCH, SA em vigor no momento da expedição.
- 4.2. A Tabela de preços poderá ser alterada sem qualquer aviso prévio.
- 4.3. Em caso de publicação e divulgação de nova Tabela de Preços e no prazo de 8 dias úteis seguintes à sua divulgação, o Cliente poderá anular, por escrito, qualquer encomenda ainda não executada ou expedida pela ARCH, SA.
- 4.4. Consideram-se aceites pelos Clientes os preços constantes da nova tabela para as encomendas em curso e que não tenham sido objecto de anulação.
- 4.5. Os preços constantes da Tabela de Preços serão sempre líquidos de impostos em vigor, os quais serão devidamente discriminados em documentos de facturação.
- 4.6. Os preços constantes da Tabela de Preços serão acrescidos de despesas efectuadas com expedição e transporte da mercadoria e / ou embalagem especial quando solicitado pelo Cliente e aceite pela ARCH, SA.
- 4.7. As despesas efectuadas com o envio de mercadorias em embalagens especiais serão imputadas aos preços constantes deste preço sempre que as referidas embalagens sejam solicitadas pelo Cliente e aceites pela ARCH, SA.

## 5. Pagamentos

- 5.1. O pagamento das facturas rege-se pelas “Condições Gerais de Pagamento” da ARCH, SA em vigor à data da expedição.
- 5.2. Se o Cliente se constituir em mora, a ARCH, SA reserva-se o direito de suspender a execução de encomendas em curso de processamento ou recebidas entretanto.
- 5.3. Sempre que a ARCH, SA tomar conhecimento de factos e circunstâncias que originem fundado receio de incumprimento de obrigações por parte do Cliente, poderá suspender o processamento e entrega de encomendas efectuadas, salvo mediante garantias fundamentadas do Cliente que honrará os seus compromissos de pagamento em prazo acordado e aceite pela ARCH, SA.

## **6. Garantia de Artigos Cerâmicos**

- 6.1. A ARCH, SA dá garantia de 20 anos sobre todos os artigos cerâmicos Sanitários da sua conceção e produção, considerando a data de venda.
- 6.2. Os artigos que durante este período apresentem algum problema técnico ou de qualidade evidente e da responsabilidade da ARCH, SA, serão substituídos sem custos para o Cliente.
- 6.3. Para que a garantia seja ativada, é imprescindível que os defeitos sejam comunicados por escrito aos serviços comerciais da ARCH, SA, acompanhados dos respetivos documentos comprovativos da venda e entrega por parte da ARCH, SA para devida comprovação de origem e data de entrega.
- 6.4. A aceitação da reclamação será condicionada por validação técnica dos nossos serviços técnicos, para despistagem de causas não cobertas pela garantia aqui descrita, como uso indevido, deficiente instalação ou manutenção, danos de transporte, manipulações, reparações ou alterações efetuadas por terceiros, sem o nosso consentimento escrito.
- 6.5. A garantia sobre produtos cerâmicos por nós concebidos e produzidos, exclui toda e qualquer responsabilidade decorrente de consequências relativas a incompatibilidade técnica de instalações do Cliente, más condições de operação da instalação, assim como condições indevidas de armazenamento ou manuseamento e não aceitaremos nenhuma reclamação por despesas com as mesmas, assim como responsabilidades legais por danos ou prejuízos.
- 6.6. O material reclamado será repostado pela ARCH, SA no mais curto espaço de tempo e de acordo com a disponibilidade de material igual ao reclamado.

## **7. Garantia de componentes não cerâmicos**

- 7.1. A ARCH, SA garante por período de 3 anos, desde a data de compra (comprovada), os produtos não cerâmicos por si comercializados e a seguir discriminados:
  - Componentes dos mecanismos de descarga: Válvulas, vedantes, tanques.
  - Componentes das Bacias: Sistemas de fixação, tampos, tubos de descarga
  - Componentes dos Bidés: Torneiras, válvulas, tampo, e fixação
  - Componentes de Lavatórios: Torneiras, válvulas, fixações.
- 7.2. Para que a presente garantia seja válida, os equipamentos deverão ser instalados de acordo com as nossas instruções técnicas de montagem e operação.
- 7.3. A presente garantia não cobre reclamações que resultem de uso indevido, desgaste prematuro por condições de utilização não destinadas à sua configuração ou funcionalidade, alterações realizadas por terceiros, manutenção negligente, desadequação às instalações do Cliente.

## **8. Reclamações**

- 8.1. Todas as reclamações relacionadas com a entrega de mercadorias (quebras, erros quantidade, faltas, etc) terão de ser efectuadas por escrito para os nossos serviços comerciais num período máximo de 5 dias úteis a contar da data (confirmada) de receção.
- 8.2. Qualquer reclamação de discordância de preços ou descontos praticados na fatura deverá ser efectuada por escrito para serviços comerciais até 15 dias após a data de receção da mesma.
- 8.3. Qualquer reclamação técnica ou de qualidade dos nossos produtos e mercadorias, deverá ser comunicada por escrito para os nossos serviços comerciais, com a descrição do problema, peças e quantificação de artigos envolvidos. O Cliente deverá garantir a guarda do material defeituoso até à sua substituição, sem custos para o Cliente, após devido processamento e aceitação de reclamação por parte da ARCH, SA.
- 8.4. A ARCH, SA procederá de forma a assegurar uma resposta em tempo útil à reclamação de cada Cliente, cujo tempo de resolução estará condicionado pelo processo de análise de causas e a necessária clarificação de responsabilidades.

225 >

## **9. Devoluções**

- 9.1. A ARCH, SA não aceitará qualquer devolução sem a prévia validação escrita do seu departamento Comercial e após devida fundamentação.
- 9.2. Não serão aceites devoluções de artigos sanitários em modelos e cores que não façam, à data, parte da gama comercializada.
- 9.3. Mercadorias e componentes não existentes no portfólio comercializado à data ou com tempo de venda superior à garantia comercial.
- 9.4. Os encargos com o processo de devolução de todos os produtos serão da responsabilidade do Cliente.

## **10. Litígios**

- 10.1. O foro competente para dirimir qualquer litígio emergente das transações comerciais reguladas pelas presentes "condições gerais de Venda" é o da comarca de Vila Nova de Gaia.
- 10.2. De acordo com a lei n.º 144/2015 de 8 de Setembro, em caso de litígio o cliente pode recorrer ao Centro de Informação de Consumo e Arbitragem do Porto para resolução alternativa de litígios de consumo.

## **CONDIÇÕES GERAIS DE PAGAMENTO**

1. Os fornecimentos a novos Clientes terão de ser liquidados por cheque ou numerário contra entrega da mercadoria. A abertura de crédito só poderá ser concedida após aprovação da Direção Financeira e da Direção Comercial da ARCH, SA.
2. Uma vez acordada a concessão de crédito e estabelecido o plafond respetivo, todas as faturas terão de ser liquidadas a um prazo máximo de 60 dias após a data de emissão.
3. No início de cada mês será emitido um resumo das faturas relativas ao mês anterior.
4. Serão concedidos descontos financeiros de acordo com as condições definidas em contrato com o Cliente ou aplicando regra geral de 2% de desconto financeiro a pronto pagamento.
5. A ARCH, SA reserva o direito de debitar juros compensatórios sempre que não se verifique o cumprimento das condições de pagamento aqui estabelecidas. Em caso algum será aceite como justificação para o não pagamento numa fatura, a existência de situações pendentes relativas a outros fornecimentos.
6. Haverá suspensão de fornecimentos sempre que ocorra uma das seguintes situações:
  - 6.1. Pagamento de mercadorias seja efetuado com cheque sem provisão
  - 6.2. Existam faturas vencidas por liquidar sem uma devida justificação
  - 6.3. O plafond de crédito concedido tenha sido ultrapassado.
7. A nenhum Cliente com crédito suspenso será satisfeito qualquer encomenda, mesmo que o novo fornecimento seja contra pronto pagamento.
8. Em caso algum a ARCH, SA aceitará letras como forma de pagamento, mesmo que os encargos fiquem por conta do Cliente.

## **CONDIÇÕES GERAIS**

1. A todos os preços da Tabela de Preços acresce o valor de I.V.A. à taxa em vigor.
2. Os preços da Tabela de Preços podem ser alterados sem aviso prévio.
3. As características e dimensões dos artigos constantes da Tabela de Preços estão sujeitas às 4. tolerâncias técnicas regulamentadas em normas do sector de atividade.
4. Reserva-se o direito de eliminar e alterar referências a artigos e mercadorias comercializadas e constantes da Tabela de Preços.
5. A comercialização dos referidos produtos está sujeita às condições gerais de venda e pagamento constantes do presente preçoário.

# CONDICIONES GENERALES DE VENDA

## INTRODUCCIÓN

Todas las relaciones comerciales entre ARCH, SA y sus clientes son reguladas por las "condiciones generales de venta" que junto las "condiciones generales de pago" se consideran aceptadas integralmente por el comprador en el momento de la compra.

### 1. Catálogos, ofertas y pedidos

- 1.1. Todas las indicaciones y características que constan en la publicidad y material informativo están sujetas a las tolerancias establecidas por las reglas internas en conformidad con las normas del sector.
- 1.2. Cualquier pedido realizado a ARCH, SA se tendrá que hacer por escrito, con la debida identificación del cliente, fecha y descripción técnica conforme las referencias del producto.
- 1.3. Todos los pedidos serán para los debidos efectos sujetos a confirmación por escrito de la parte del cliente.
- 1.4. Cualquier condición estipulada por el cliente en sus pedidos y que no esté conforme con las presentes "condiciones de venta" así como en las "condiciones generales de pago" se considerarán sin efecto y serán confirmadas por escrito por ARCH, SA con posterioridad.

### 2. Cancelación de pedidos

- 2.1. ARCH, SA se reserva el derecho de cancelar un pedido en los siguientes casos:
  - Cuando hubiera incumplimiento parcial o total de contratos anteriores.
  - Cuando el cliente se niega a recibir la mercancía después de la expedición de la misma y mediante previa confirmación del pedido.
  - Siempre que se constate un comportamiento indebido en detrimento de ARCH, SA.

### 3. Entregas

- 3.1. Los plazos de entrega se definen entre ARCH, SA y el cliente durante el transcurso del pedido. Si no hubiera nada estipulado el plazo de referencia para la entrega es de 30 días laborables. Si no fuese posible garantizar un plazo estipulado, ARCH, SA se compromete a avisar el cliente con un nuevo plazo.
- 3.2. Todos los pedidos se podrán satisfacer mediante entregas parciales.
- 3.3. Todos los productos y mercancías que se hayan recogido a través del transporte del cliente se considerarán como entregados en el momento de su carga mediante la firma del albarán por el correspondiente conductor siempre y cuando la responsabilidad del transporte recaiga en el cliente. En estos casos no se aceptarán reclamaciones a posteriori sea por faltas o daños.
- 3.4. Cuando la responsabilidad del transporte recaiga en ARCH, SA la mercancía se considerará como entregada en el momento de la firma del albarán en el destino acordado.
- 3.5. El acto de recepción de la mercancía por parte del cliente implica la confirmación de su contenido y consecuente conformidad de acuerdo con el pedido efectuado y/o con los documentos del transporte que lo comprueben. Cualquier anomalía se deberá registrar en el albarán de ARCH, SA y en el respectivo documento de transporte.
- 3.6. En el caso que no se pueda comprobar la mercancía en el acto de entrega, el cliente tendrá que hacer referencia en el albarán y documento de transporte el siguiente comentario "sujeto a confirmación". Cualquier anomalía deberá ser comunicada por el cliente por escrito para nuestros servicios comerciales en tiempo útil y nunca superior a 5 días laborables después de la recepción de la mercancía.
- 3.7. ARCH, SA se puede negar a realizar un transporte de la mercancía en las siguiente circunstancias:
  - Cuando el destino no sea el almacén del cliente o el local de entrega estipulado en el pedido.
  - Cuando la cantidad pedida no lo justifique.
  - Si el cliente se recusa a descargar la mercancía por motivos no imputables a ARCH, SA en cuyo caso se procederá al cargo del transporte y demás costes adicionales que puedan surgir como consecuencia de ese acto.
  - ARCH, SA se reserva el derecho de considerar sin efecto todo pedido que quede en espera más de 30 días después de su disponibilidad sin que el cliente proceda a la respectiva recogida

### 4. Precios

- 4.1. Los precios practicados son los que constan en la tarifa de ARCH, SA en vigor en el momento de la expedición.
- 4.2. Se podrá alterar la tarifa sin previo aviso.
- 4.3. El cliente podrá anular en un plazo de 8 días laborables posteriores a la publicación de la nueva tarifa, cualquier pedido en curso no efectuado o expedido por ARCH, SA.
- 4.4. Los pedidos en curso que no hayan sido anulados después del tiempo transcurrido para ese efecto tendrán como base los nuevos precios.
- 4.5. Los precios que constan en la tarifa serán siempre antes de los impuestos en vigor y los cuales aparecerán en las respectivas facturas.
- 4.6. Los precios de tarifa podrán sufrir un aumento según eventuales costes de expedición, transporte y/o embalaje especial que sean solicitados por el cliente y aceptados por ARCH, SA.
- 4.7. Los gastos en que incurra el envío de la mercancía en embalaje especial se imputarán a los precios indicados en esta tarifa siempre que dicho embalaje sea solicitado por el Cliente y aceptado por ARCH, SA.

### 5. Pagos

- 5.1. El pago de facturas se rige por las "condiciones Generales de Pago" de ARCH, SA. en vigor a la fecha de expedición.
- 5.2. Si el Cliente entra en mora, ARCH, SA se reserva el derecho de suspender los pedidos pendientes de servicio.
- 5.3. Siempre que ARCH, SA tome conocimiento de hechos y circunstancias que puedan originar un incumplimiento por parte del cliente, esta podrá suspender los pedidos en curso salvo mediante la presentación de garantías de pago fidedignas por parte del cliente y que sean previamente aprobadas por ARCH, SA.

## **6. Garantía de Productos cerámicos**

- 6.1. ARCH, SA ofrece una garantía de 20 años sobre todos los artículos cerámicos Sanitarios de su autoría a partir de la fecha de venta.
- 6.2. Los artículos que durante ese período presenten algún problema técnico o de calidad evidente serán substituidos sin cualquier coste para el cliente y desde que sea responsabilidad de ARCH, SA.
- 6.3. Es imprescindible que los defectos sean comunicados por escrito a los servicios comerciales de ARCH, SA para que se produzca la activación de la mencionada garantía. Esa comunicación deberá ir acompañada de los documentos comprobantes de la venta y entrega por ARCH, SA para efectos de verificación de origen y fecha de entrega.
- 6.4. La aceptación de la reclamación estará condicionada por la validación técnica de nuestros servicios técnicos para un apuramiento de eventuales causas que puedan estar fuera de la cobertura de la garantía como el uso indebido y deficiente de la instalación o mantenimiento, desperfectos en el transporte, manipulaciones, reparaciones o alteraciones efectuadas por terceros sin un previo acuerdo o consentimiento por escrito.
- 6.5. La garantía sobre los productos cerámicos concebidos y producidos por ARCH, SA excluye toda y cualquier responsabilidad que transcurra de consecuencias relativas a la incompatibilidad técnica de las instalaciones del cliente, malas condiciones de operatividad de las instalaciones, así como condiciones indebidas de almacenaje o manejo y no se aceptará ninguna reclamación por gastos con las mismas así como responsabilidades por daños y perjuicios.
- 6.6. Se repondrá el material reclamado en el espacio de tiempo más breve posible y de acuerdo con la disponibilidad del material igual al reclamado.

## **7. Garantía de componentes no cerámicos**

- 7.1. ARCH, SA garantiza por un período de 3 años, desde la fecha de compra (comprobada), los productos no cerámicos que se siguen:
  - Componentes de los mecanismos de descarga: Válvulas, aislantes, tanques.
  - Componentes de los inodoros: Sistemas de fijación, tapas, tubos de descarga
  - Componentes de los Bidés : Grifos, válvulas, tapas, y fijación
  - Componentes de los lavabos: Grifos, válvulas, tapas, y fijaciones.
- 7.2. Para que la presente garantía sea válida, los equipos deberán ser instalados de acuerdo con nuestras instrucciones técnicas de montaje y operación.
- 7.3. La presente garantía no cubre reclamaciones que resulten del uso indebido, desgaste prematuro por condiciones de utilización no destinadas a su configuración o funcionalidad, alteraciones realizadas por terceros, mantenimiento negligente o inadaptación a las instalaciones del cliente.

## **8. Reclamaciones**

- 8.1. Todas las reclamaciones relacionadas con la entrega de mercancías (quebras, errores de cantidad, faltas etc.) se tendrán que efectuar por escrito a nuestros servicios comerciales en un tiempo máximo de 5 días laborables a partir de la fecha (comprobada) de entrega.
- 8.2. Cualquier reclamación sobre la disputa de precios o descuentos constantes en la factura se tendrá que efectuar por escrito hasta 15 días después de la recepción de la misma.
- 8.3. Se deberá comunicar por escrito para nuestros servicios comerciales cualquier reclamación técnica o de calidad de nuestros productos y mercancías con la descripción del problema, piezas y cuantificación de los artículos en cuestión. El cliente deberá garantizar el almacenaje del material defectuoso hasta su substitución, sin costes para el, y solamente después de la aceptación previa por parte de ARCH, SA de la respectiva reclamación.
- 8.4. A ARCH, SA siempre procederá de manera a dar una respuesta a la reclamación de cada cliente en tiempo útil y cuya solución dependa de las causas y el apuramiento de responsabilidades.

227 >

## **9. Devoluciones**

- 9.1. ARCH, SA no aceptará cualquier devolución sin la aceptación previa por escrito del departamento comercial y mediante la debida fundamentación.
- 9.2. No se aceptarán devoluciones de artículos sanitarios cuyos modelos y colores no hagan parte de la gama actual en comercialización.
- 9.3. No se aceptarán mercancías y componentes que no existan en la gama comercializada presentemente o con tiempo de venta superior a la garantía comercial.
- 9.4. Los gastos del proceso de devolución de todos los productos correrán a cargo del Cliente.

## **10. Litigios**

- 10.1. El fuero competente para dirimir cualquier litigio resultante de las transacciones comerciales reglamentadas por las presentes "condiciones generales de venta" es el de la comarca de Vila Nova de Gaia.
- 10.2. De acuerdo con la Ley n° 144/2015 del 8 de Septiembre, em caso de litigio el cliente puede recurrir al " Centro de Informação de Consumo e Arbitragem" de Porto para una resolución alternativa de litigios al consumo.

## **CONDICIONES GENERALES DE PAGO**

1. Los suministros de nuevos clientes se tendrán que pagar mediante cheque o en efectivo al entregar la mercancía. La apertura de crédito solamente se podrá efectuar mediante la aprobación previa de la dirección Financiera y Comercial de ARCH, SA.
2. Una vez que se aprueba la apertura de crédito y el respectivo limite, todas las facturas tendrán que ser liquidadas pasados 60 días de la fecha de emisión de las mismas.
3. Al inicio de cada mes se emitirá un resumen de las facturas del mes anterior.
4. Los descuentos financieros se concederán de acuerdo con las condiciones especificadas en el contrato de cada cliente o aplicando la regla general del 2% de descuento a pronto pago.
5. ARCH, SA se reserva el derecho a cobrar intereses de demora siempre y cuando no se verifiquen las condiciones de pago aqui establecidas. En ninguna circunstancia se aceptará como justificación del impago la existencia de situaciones pendientes relativas a otros suministros.
6. Habrá suspensión de suministros siempre que ocurra una de las siguientes situaciones:
  - 6.1. Pago de mercancías con un cheque sin fondo.
  - 6.2. Existencia de facturas en atraso sin la debida justificación.
  - 6.3. Alcanzar el Límite de crédito.
7. No habrá nuevo suministro una vez que el crédito se encuentre anulado aún cuando el nuevo suministro sea a pronto pago.
8. En ningún caso se aceptarán letras de cambio como forma de pago aun cuando los gastos corran por cuenta del cliente.

## **CONDICIONES GENERALES**

1. Los precios en la tarifa no incluyen el IVA.
2. Los precios en la tarifa pueden sufrir alteraciones sin previo aviso.
3. Las características y dimensiones de los artículos que figuran en la tarifa se someterán a las tolerancias técnicas especificadas en las respectivas normas del sector.
4. Se reserva el derecho de eliminar o alterar referencias a artículos y mercancías constantes en la tarifa.
5. La comercialización de los citados productos está sujeta a las condiciones generales de venta y pago establecidas en la presente lista de precios.

# GENERAL CONDITIONS OF SALE

## INTRODUCTION

All commercial relations between ARCH, SA and its Clients are ruled by the following "General Terms of Sale" which, together with the "General Terms of Payment" are deemed to have been fully accepted by the purchaser at the time its order is made.

### 1. Catalogues, offers and orders

- 1.1. All indications and characteristics stated in our advertising material are subject to the tolerances defined in the Quality Assurance System in accordance with the standards in force for the sector.
- 1.2. Any order to ARCH, SA shall be made in writing by way of a duly numbered requisition on company headed paper, date and technical description on our catalogue references.
- 1.3. To all intents and purposes, all orders are subject to acceptance in writing.
- 1.4. Any condition stipulated by the Client in its requests which does not conform to the present "General Terms of Sale" or to the "General Terms of Payment" shall be deemed null and void, unless subsequently confirmed in writing by ARCH, SA.

### 2. Suspension of orders

- 2.1. ARCH, SA reserves the right to suspend the execution of any order in the following cases:
  - When the Customer has not given partial or full compliance with previous contracts;
  - When by the Customer to check refuses to receive their orders after loading and dispatch as prior order;
  - Where there is Customer misconduct to the detriment of ARCH, SA.

### 3. Deliveries

- 3.1. The delivery dates are agreed upon between ARCH, SA and its Clients. Should nothing be formally stipulated by both parties, the delivery date to be assumed shall be of 30 days. Whenever this cannot be met, ARCH, SA undertakes to notify the Client and agree upon a new date.
- 3.2. Any order may be carried out through partial deliveries.
- 3.3. The goods are deemed to have been delivered to the Client as soon as their loading onto the truck has been completed at ARCH, SA warehouse and the respective Delivery Slip has been signed by the driver, with transport being wholly the responsibility of the Client meaning that, in such cases, no complaints shall be accepted owing to the breakage of material or goods missing.
- 3.4. Whenever transport is carried out in transport chartered by ARCH, SA the goods shall be deemed to have been delivered upon their receipt at the destiny.
- 3.5. The Client shall verify upon receipt whether the products correspond to those ordered by it. Any irregularity shall be registered on ARCH, SA Delivery Slip as well as on the Transporter Slip.
- 3.6. Should it not be possible to verify the goods upon delivery, the Client shall write on the corresponding Delivery Slips and on the Transporter Slip "Subject to Conferral". Any irregularity detected shall be communicated to our commercial services in writing within no more than 5 days
- 3.7. ARCH, SA may refuse to transport orders whenever:
  - The place of destination is not the Client's warehouse or that agreed upon previously;
  - The volume of the order does not so justify.
  - Whenever there is a refusal to receive, for reasons not attributable to ARCH, SA, the Client shall be charged an amount corresponding to the value of transport.
  - ARCH, SA reserves the right to deem null and void any order remaining over 30 days after it was made without the Client having collected it.

### 4. Prices

- 4.1. The prices charged are always those set out in the Price Table of ARCH, SA in force at the time of dispatch of the goods.
- 4.2. The Price Table may be altered without any prior notice.
- 4.3. Owing to the coming into force of the new Price Table of ARCH, SA, and within eight days after its disclosure, the Client may cancel, in writing, any order yet to be implemented or dispatched by ARCH, SA.
- 4.4. In case of projects in study with deliveries scheduled for the coming year, the proposed prices shall have the validity of the budget even if some change in the price list occurs in that period.
- 4.5. The prices set out in the table shall be deemed to have been accepted by the Clients whenever their orders have not been subject to cancellation in accordance to the point.
- 4.6. The prices stated in the Table are always net of the taxes in force which shall always be itemised on the invoices.
- 4.7. Any expenses defrayed on dispatching goods in special packaging shall accrue to the prices stated in this price list whenever said packaging is requested by the Client and accepted by ARCH, SA.

### 5. Payments

- 5.1. The payment of invoices is subject to the "General Terms of Payment" of ARCH, SA in force as at the date of dispatch.
- 5.2. If the Client is late in making payment, ARCH, SA reserves the right to suspend the implementation and dispatch of any orders in portfolio.
- 5.3. Whenever ARCH, SA learns of any facts and circumstances which cause well-founded fears of breaches in compliance with obligations by the Client, it may suspend the delivery of goods, unless the purchaser provides guarantees in a timeframe to be agreed upon.

## 6. Guarantee of ceramic components

- 6.1. ARCH, SA gives guarantee of 20 years from buying date to all ceramic products conceived and produced by them.
- 6.2. All the ceramic wares that during this period show any problem due to any material defect or manufacturing one will be replaced to the customer for free.
- 6.3. In order to activate the guarantee it is necessary that all defects are communicated immediately by written to ARCH, SA , together with invoice or other document issued by us proving the origin and delivery date of the product.
- 6.4. The acceptance of the claim shall be conditioned by our Quality Department to verify causes non covered by this guarantee such as negligence, bad installation and/ or maintenance, transport damages, handling, repairs or intervention done by third parties without our Previous written permission.
- 6.5. The guarantee about ceramic products conceived and produced by ARCH, SA exclude all and any responsibility coming from technical incompatibility of Client premises, bad conditions of installing process, and also improper storage or handling conditions. ARCH, SA shall not accept any claim of expenses occurred from those referred situations as well as legal responsibility for damages or prejudices.
- 6.6. The claimed material will be replaced by ARCH, SA in the shortest period and according to the availability of such material.

## 7. Guarantee of non ceramic components

- 7.1. A ARCH, SA grants 3 years guarantee from buying date (duly proved) on the bellow non-ceramic products:
  - Discharge Mechanisms components: Valves, sealant system and plastic cisterns;
  - WC components: Seats, fixation systems and discharge pipes;
  - Bidet components: Taps, valves, seats and fixation systems;
  - Washbasins components: Taps, valves and fixation systems.
- 7.2. This Guarantee comes in force always and when all the proceedings written on installation manual have been followed (if applicable).
- 7.3. The present guarantee does not cover claims occurring from the misuse, premature deterioration for usage conditions not designated to its configuration or functionality, changes done by third parties, negligent maintenance, inadequate to client's premises.

## 8. Claims

- 8.1. As specified in 3.1 all claims related to the delivery of products (breaks, quantity errors, failures, etc) must be made in writing to Commercial Department within a period of 5 days from the date of receipt of the same.
- 8.2. Any claim owing to a disagreement over the prices or discounts made to the invoice shall be lodged in writing to Commercial Department within 15 days after receipt thereof.
- 8.3. Any technical or quality claim of our products must be communicated by written to our Commercial services with full description of the problem, pieces and quantification. The client must guarantee to keep the materials properly until its replacement after verification and acceptance of the claim by ARCH, SA.
- 8.4. ARCH, SA shall assure a reply in appropriate time to each Client claim, which resolution time shall be conditioned by the confirmation of responsibilities.

229 >

## 9. Returns

- 9.1. ARCH, SA will not accept any return without the prior authorisation in writing of its Commercial Department.
- 9.2. Under no circumstances shall returns be accepted of sanitary ware in models or colours which do not, to date, form part of the current range
- 9.3. All products and components non existent in the catalogue to date or with selling date superior to commercial guarantee.
- 9.4. The charges with the return process of all the products shall be on the Clients responsibility.

## 10. Disputes

- 10.1. The competent venue for settling any litigation arising out of the commercial transactions regulated by the present "General Terms of Sale" is the District of Vila Nova de Gaia.
- 10.2. According to Law No. 144/2015 of September 8, in the event of litigation the customer may use the Consumer Information and Arbitration Center of PORTO for alternative resolution of consumer disputes

## GENERAL TERMS OF PAYMENT

1. Supplies to new Clients must be paid upon delivery of goods. Credit shall only be granted after approval of the Financial Management and the Commercial of ARCH, SA.
2. Once it has been agreed to grant credit and the respective limit has been established, all invoices must be settled within 60 days after the date of the respective issue.
3. At the start of each month a summary of invoices shall be issued relating to the previous month.
4. A prompt payment discount shall be granted (in cheque, cash or bank transfer) with order acceptance, or with payment in the delivery date, or by payment at loading date, or by financial discount with payment till 15 days after invoice date, according personalized conditions.
5. ARCH, SA has the right to cancel given discounts all the time the terms of payment previously established are not fulfilled.
6. Supplies shall be suspended in the event of any of the following situations:
  - 6.1. The payment of the goods and/or costs has been made with a bouncing cheque;
  - 6.2. There are documents due and unpaid without proper justification;
  - 6.3. The credit plafond assigned has been exceeded.
7. Any Client whose credit has been suspended cannot make an order even if prompt payment is made
8. In any case, ARCH, SA shall accept bill of exchanges as payment, even with charges on client's account.

## GENERAL CONDITIONS

1. All prices in the price list are subject to vat at the legal rate in force.
2. Prices may be changed without prior notice.
3. The characteristics and measurements shown are subject to some technical tolerances, according to the norms of this activity sector.
4. We reserve the right to alter and/or eliminate products shown in this price list
5. The commercialisation of the aforementioned products is subject to the general terms of sale and payment set out in this price list.

# CONDITIONS GÉNÉRALES DE VENTE

## INTRODUCTION

Toutes les relations entre ARCH, SA et ses clients seront régularisées par les présentes conditions « générales de vente » qui, additionnées aux « conditions générales de paiement », sont considérées comme intégralement acceptées par l'acheteur lors de la commande.

### 1. Catalogues, offres et commandes

- 1.1. Toutes les indications et caractéristiques spécifiées sur les supports publicitaires et informatifs sont assujetties aux tolérances définies par les normes de régulation interne et en accord avec les normes du secteur.
- 1.2. Quelconque commande adressée à ARCH, SA devra être réalisée par écrit, avec l'information nécessaire étant : Identification du client, date et description technique associée à la référence de l'article.
- 1.3. Toutes les commandes seront, pour tous les effets, conditionnées à la confirmation par écrit du client.
- 1.4. Toute condition stipulée par le client lors de sa demande et qui soit pas en accord avec ces « conditions générales de vente » ainsi que les « conditions générales de paiement » seront considérées sans effet, avec postérieure confirmation écrite par Arch, SA.

### 2. Suspension de command

- 2.1. ARCH, SA se réserve le droit de suspendre l'exécution de quelconque commande dans les situations suivantes:
  - Que le client n'a pas honoré partiellement ou totalement ses obligation sur un contrat antérieur.
  - Quand, de la part du client, il y aura un refus de réception de commande suivant la charge et expédition de cette commande.
  - Dans tout les cas ou il y aura une conduite inappropriée du client envers ARCH, SA.

### 3. Livraison

- 3.1. Les délais de livraison sont accordés entre ARCH, SA et le Client au cours de la commande. Si rien n'est stipulé par aucune des parties, le délai de référence pour la livraison sera de 30 jours ouvrés. Dans le cas ou il ne serait pas possible garantir le délai accordé lors de la commande, ARCH, SA s'engage à prévenir le client et convenir d'une nouvelle date de livraison.
- 3.2. Toute commande pourra être exécutée pour des livraisons partielles.
- 3.3. Les articles sont considérés livrés au client au moment de la charge sur le moyen de transport du client et le bon de livraison signé par l'opérateur chargé de ce transport quand celui-ci est la responsabilité du client. Dans ce cas de figure, ne sera acceptée aucune réclamation postérieure pour manque ou casse des articles livrés.
- 3.4. Dans le cas ou la livraison est de la responsabilité de ARCH, SA les articles seront considérés livrés lors de la bonne réception et validation du destinataire.
- 3.5. La validation de réception de la marchandise par le client implique la vérification et la conformité du contenu en accord avec la commande passée et les documents de bon de livraison. Quelconque anomalie devra être spécifiée sur le bon de livraison.
- 3.6. Dans le cas ou il ne serait pas possible une vérification de la marchandise livrée au moment de la livraison, le client devra signer le bon de livraison en ajoutant la mention « sous conditions de vérification ».  
Quelconque anomalie devra être communiquée par écrit par le client auprès de notre service commercial dans un délai maximum de 5 jours ouvrés à date de réception de la marchandise.
- 3.7. ARCH, SA pourra refusé de transporté la marchandise dans les conditions suivantes :
  - L'adresse de livraison ne correspond pas à l'entrepôt du client ou à l'adresse communiquée lors de la commande.
  - Le volume de la commande ne justifie pas
  - Dans le cas de refus de réception non imputable à ARCH, SA et étant ainsi facturé au client la valeur de ce transport et autres coûts associés
  - ARCH, SA se réserve le droit de considéré sans effet toute commande qui serait en attente plus de 30 jours dans nos installations sans que le client procède à sa récupération.

### 4. Tarifs

- 4.1. Les tarifs pratiqués sont les prix indiqués sur le relevé tarifaire de ARCH, SA en vigueur au moment de l'expédition.
- 4.2. Le relevé tarifaire pourra subir des modifications sans aucun préavis.
- 4.3. Dans le cas de la communication du nouveau relevé tarifaire et dans un délai de 8 jours, le client pourra annulé par écrit quelconque commande pas encore produite ou expédiée par ARCH, SA.
- 4.4. Seront considérés comma acceptés par le client les tarifs indiqués par ce nouveau relevé tarifaire pour les commandes en cours et qui n'auront pas été annulées.
- 4.5. Les tarifs indiqués sur le relevé tarifaire seront toujours mentionnés hors taxes.
- 4.6. Les tarifs indiqués sur le relevé tarifaire pourront subir des hausses suivant les surcoûts engendrés par l'expédition et le transport des marchandises avec des emballages spéciaux demandés par le client et acceptés par ARCH, SA.
- 4.7. Toutes les dépenses engagées pour l'envoi de marchandises dans des emballages spéciaux seront imputées sur les prix indiqués dans cette liste de prix chaque fois que cet emballage est demandé par le Client et accepté par ARCH, SA.

### 5. Paiements

- 5.1. Le paiement des factures et régi par les « conditions générales de paiement » de ARCH, SA en vigueur à la date d'expédition.
- 5.2. Si le client subit un retard de paiement, ARCH, SA se réserve le droit de suspendre la commande en cours ou les commandes reçues entretemps
- 5.3. Dans le cas ou ARCH, SA prendrait connaissances de faits et circonstances qui pourraient engendrer le non-respect des obligations du client, se réserve le droit de suspendre la production et livraison des commandes en cours, sauf dans le cas ou le client présente des garanties qu'il pourra honoré ses obligations de paiement dans les délais accordés avec ARCH, SA.



## 6. Garantie des produits céramiques

- 6.1. ARCH, SA offre une garantie de 20 ans sur tout les articles céramiques sanitaires conçu et produits par ARCH, SA à compté de la date de vente.
- 6.2. Les produits qui, durant cette période, présenteraient quelconque problème technique ou qualitatif seront échangés sans aucun coût pour le client.
- 6.3. Pour que la garantie soit activée, il est nécessaire que les défauts soient communiqués par écrit au service commercial de ARCH, SA et accompagnés des respectifs documents prouvant la vente et livraison de la part de ARCH, SA pour ainsi prouvé l'origine et la date de livraison.
- 6.4. L'acceptation de la réclamation sera conditionnée par la validation de nos services techniques, pour la détection des causes couvertes par la garantie ici décrite, tel que usage inadéquat, défaut lors de l'installation ou manutention, casse lors du transport, manipulations, réparations ou modifications effectuées par un tiers, sans notre consentement par écrit.
- 6.5. La garantie sur les produits céramiques conçu et produits par nos soins, exclus toute responsabilité provenant d'éventuelles incompatibilités techniques des installations du client, mauvaises conditions d'installation, ainsi que quelconque mauvaise condition de stockage ou manutention et nous n'accepterons aucune réclamation pour les dépenses engendrées par ces points.
- 6.6. Le matériel réclamé sera fourni par ARCH, SA le plus rapidement possible dans la mesure de la disponibilité du matériel identique.

## 7. Garantie sur les composant non céramiques

- 7.1. ARCH, SA garanti 3 ans, à partir de la date d'achat, les produits non céramiques commercialisés et décrits ci-dessous:
  - Composants des mécanismes de décharge : Vannes, joints, réservoirs.
  - Composants des WC : Systèmes de fixation, abattants, tuyaux d'évacuation.
  - Composants des bidets : Robinets, vannes, abattants et fixations.
  - Composants des lavabos : Robinets, vannes et fixations.
- 7.2. Pour que la présente garantie soit valide, les équipements devront être installés en accord avec nos instructions techniques.
- 7.3. La présente garantie ne couvre pas les défauts dus à une mauvaise utilisation, une usure prématurée pour cause de mauvais utilisation, configuration ou fonctionnalité, modifications réalisés par un tiers.

## 8. Réclamations

- 8.1. Toutes les réclamations en relation avec la livraison de la marchandise devront être effectuées par écrit auprès de notre service commercial dans un délai de 5 jours ouvrés à partir de la date de livraison.
- 8.2. Toutes les réclamations au sujet des tarifs ou remises pratiqués sur la facture devront être effectuées par écrit auprès de notre service commercial dans un délai de 15 jours après la date de réception de cette facture.
- 8.3. Toutes les réclamations techniques ou de qualités des nos produits et marchandises devront être réalisées par écrit auprès de notre service commercial, avec le descriptif du problème, pièces et quantitatif des articles concernés. Le client devra garantir le maintien de ces articles jusqu'à la récupération de ces derniers par ARCH, SA, sans coût pour le client, après bonne acceptation de la réclamation par ARCH, SA.
- 8.4. ARCH, SA agira de façon a assuré une réponse en temps utile à la réclamation du client, dont le temps de résolution sera conditionné par l'analyse des causes et le nécessaire éclaircissement des responsabilités.

231 >

## 9. Retour

- 9.1. ARCH, SA n'acceptera aucun retour sans antérieure validation par écrit du service commercial
- 9.2. ARCH, SA n'acceptera aucun Retour d'articles sanitaires, modèles et coloris, que ne font pas, à la date du retour, partie de la gamme commercialisée.
- 9.3. Marchandises et composants ne faisant pas parti du catalogue commercialisé à la date du retour ou avec une date de vente supérieure a la garantie commerciale.
- 9.4. Les frais de retour de tous les produits sont à la charge du client.

## 10. Litiges

- 10.1. Le tribunal compétent pour intervenir dans quelconque litige émergeant des transactions commerciales régies par les présentes « conditions générales de vente » sera le Tribunal de Vila Nova de Gaia.
- 10.2. EN accord avec la loi 144/2015 du 8 septembre, en cas de litige le client peut recourir au « Centre d'Information de Consommation et Arbitrage » de Porto pour une résolution alternative de litiges de consommation

## CONDITIONS GÉNÉRALES DE PAIEMENT

1. Les livraisons à de nouveaux clients devront être payées par chèque ou liquide lors de la livraison. L'ouverture de droit au crédit ne pourra être concédée qu'après approbation de la Direction Financière et Direction Commercial de ARCH, SA.
2. Une fois le crédit accordé avec plafonds défini, toutes les factures devront être payées dans un délai maximum de 60 jours après date d'émission.
3. En début de chaque mois sera éditée une liste de factures du mois antérieur
4. Seront accordés des escomptes en accord avec les conditions définies pour tout paiement anticipé.
5. ARCH, SA se réserve le droit de débité des intérêts compensatoires dans le cas de non-respect des conditions de paiements. En aucun cas ne sera acceptée, pour justifier le retard de paiement des facture en cours, l'existence d'une situation litigieuse sur un autre produit ou livraison.
6. Il y aura suspension de fourniture dans les cas suivants:
  - 6.1. Paiement de commande avec chèque sans provision.
  - 6.2. Des factures non réglées avec des dates de paiement dépassées.
  - 6.3. Plafond de crédit dépassé.
7. A aucun client dont le crédit a été suspendu ne sera fournie la moindre commande, même si cette nouvelle commande est payée en anticipée.
8. Dans tous les cas, ARCH, SA acceptera les lettres de change comme moyen de paiement, même avec des frais sur le compte du client.

## CONDITIONS GÉNÉRALES

1. A tous les prix spécifiés sur le relevé tarifaire sera ajouter la TVA légale en vigueur.
2. Les prix spécifiés sur le relevé tarifaire peuvent subir des modifications sans préavis.
3. Les caractéristiques et dimensions des articles spécifiés sur le relevé tarifaire sont assujettis aux tolérances techniques règlementées dans les normes du secteur d'activité.
4. ARCH, SA se réserve le droit de retirer et modifier les références des articles et marchandises commercialisés et spécifiés dans le relevé Tarifaire.
5. La commercialisation des produits précités est soumise aux conditions générales de vente et de paiement figurant dans ce tarif.





**Sede / Fábrica . *Headquarters / Factory***

Av. António Coelho Moreira  
4405-528 Vila Nova de Gaia  
Portugal

**Lisboa - Showroom**

Av. David Mourão-Ferreira 55, loja 4  
1750-448 Lisboa  
Portugal

+351 223 238 038  
comercial@archvaladares.com

[www.archvaladares.com](http://www.archvaladares.com) . [www.arch.pt](http://www.arch.pt)

